



Operating Guide

PSE 9000 3U

DC High Efficiency Power Supply

Elektro-Automatik



Attention! This document is only valid for devices with firmware "KE: 2.28" and "HMI: 2.03" and "DR: 1.0.22" or higher. For availability of updates for your device check our website or contact us.



Doc ID: PSE9TEN
Revision: 06
Date: 10/2021



TABLE OF CONTENTS

1 GENERAL

1.1	About this document	5
1.1.1	Retention and use	5
1.1.2	Copyright	5
1.1.3	Validity	5
1.1.4	Explanation of symbols	5
1.2	Warranty	5
1.3	Limitation of liability	5
1.4	Disposal of equipment	6
1.5	Product key	6
1.6	Intended usage	6
1.7	Safety	7
1.7.1	Safety notices	7
1.7.2	Responsibility of the user	8
1.7.3	Responsibility of the operator	8
1.7.4	User requirements	8
1.7.5	Alarm signals	9
1.8	Technical data	9
1.8.1	Approved operating conditions	9
1.8.2	General technical data	9
1.8.3	Specific technical data (400 V models)	10
1.8.4	Specific technical data (208 V models)	18
1.8.5	Views	19
1.8.6	Control elements	22
1.9	Construction and function	23
1.9.1	General description	23
1.9.2	Block diagram	23
1.9.3	Scope of delivery	24
1.9.4	Accessories	24
1.9.5	Options	24
1.9.6	The control panel (HMI)	25
1.9.7	USB port	27
1.9.8	Interface module slot	27
1.9.9	Analog interface	27
1.9.10	Share Bus connection	28
1.9.11	Sense connector (remote sensing)	28

2 INSTALLATION AND COMMISSIONING

2.1	Transport and storage	29
2.1.1	Transport	29
2.1.2	Packaging	29
2.1.3	Storage	29
2.2	Unpacking and visual check	29
2.3	Installation	29
2.3.1	Safety procedures before installation and use	29
2.3.2	Preparation	30
2.3.3	Installing the device	30
2.3.4	Connection to AC supply	31
2.3.5	Connection to DC loads	34
2.3.6	Connection of remote sensing	35

2.3.7	Grounding of the DC output	36
2.3.8	Connecting the "Share" bus	36
2.3.9	Connecting the analog interface	36
2.3.10	Connecting the USB port	36
2.3.11	Installation of an interface module	37
2.3.12	Initial commission	37
2.3.13	Initial network setup	38
2.3.14	Commission after a firmware update or a long period of non-use	38

3 OPERATION AND APPLICATION

3.1	Important notes	39
3.1.1	Personal safety	39
3.1.2	General	39
3.2	Operating modes	39
3.2.1	Voltage regulation / constant voltage	39
3.2.2	Current regulation / constant current / current limiting	40
3.2.3	Power regulation / constant power / power limiting	40
3.3	Alarm conditions	41
3.3.1	Power Fail	41
3.3.2	Overtemperature	41
3.3.3	Overvoltage	41
3.3.4	Overcurrent	41
3.3.5	Overpower	41
3.4	Manual operation	42
3.4.1	Switching the device on	42
3.4.2	Switching the device off	42
3.4.3	Configuration in the setup menu	42
3.4.4	Adjustment limits	47
3.4.5	Manual adjustment of set values	48
3.4.6	Switching the main screen view	48
3.4.7	The quick menu	49
3.4.8	Switching the DC output on or off	49
3.5	Remote control	50
3.5.1	General	50
3.5.2	Control locations	50
3.5.3	Remote control via a digital interface	50
3.5.4	Remote control via the analog interface (AI)	51
3.6	Alarms and monitoring	55
3.6.1	Definition of terms	55
3.6.2	Device alarm handling	55
3.7	Control panel (HMI) lock	56
3.8	Loading and saving a user profile	57
3.9	Other applications	58
3.9.1	Parallel operation in master-slave (MS)	58
3.9.2	Series connection	62
3.9.3	Operation as battery charger	62
3.9.4	Two quadrants operation (2QO)	63

4 SERVICE AND MAINTENANCE

4.1	Maintenance / cleaning.....	65
4.2	Fault finding / diagnosis / repair.....	65
4.2.1	Firmware updates	65
4.3	Calibration (readjustment)	66
4.3.1	Preface	66
4.3.2	Preparation.....	66
4.3.3	Calibration procedure	66

5 CONTACT AND SUPPORT

5.1	Repairs	68
5.2	Contact options	68

1. General

1.1 About this document

1.1.1 Retention and use

This document is to be kept in the vicinity of the equipment for future reference and explanation of the operation of the device. This document is to be delivered and kept with the equipment in case of change of location and/or user.

1.1.2 Copyright

Reprinting, copying, also partially, usage for other purposes as foreseen of this manual are forbidden and breach may lead to legal process.



1.1.3 Validity

This manual is valid for the following equipment with color TFT display:

Model	Model	Model
PSE 9040-170 3U	PSE 9040-510 3U	PSE 9080-510 3U
PSE 9080-170 3U	PSE 9080-340 3U	PSE 9200-210 3U
PSE 9200-70 3U	PSE 9200-140 3U	PSE 9360-120 3U
PSE 9360-40 3U	PSE 9360-80 3U	PSE 9500-90 3U
PSE 9500-30 3U	PSE 9500-60 3U	PSE 9750-60 3U
PSE 9750-20 3U	PSE 9750-40 3U	PSE 91000-40 3U
PSE 9040-340 3U	PSE 91000-30 3U	PSE 91500-30 3U

1.1.4 Explanation of symbols

Warning and safety notices as well as general notices in this document are shown in a box with a symbol as follows:

	Symbol for a life threatening danger
	Symbol for general safety notices (instructions and damage protection bans) or important information for operation
	<i>Symbol for general notices</i>

1.2 Warranty

EA Elektro-Automatik guarantees the functional competence of the applied technology and the stated performance parameters. The warranty period begins with the delivery of free from defects equipment.

Terms of guarantee are included in the general terms and conditions (TOS) of EA Elektro-Automatik.

1.3 Limitation of liability

All statements and instructions in this manual are based on current norms and regulations, up-to-date technology and our long term knowledge and experience. The manufacturer accepts no liability for losses due to:

- Usage for purposes other than designed
- Use by untrained personnel
- Rebuilding by the customer
- Technical changes
- Use of not authorized spare parts

The actual delivered device(s) may differ from the explanations and diagrams given here due to latest technical changes or due to customized models with the inclusion of additionally ordered options.

1.4 Disposal of equipment

A piece of equipment which is intended for disposal must, according to European laws and regulations (ElektroG, WEEE) be returned to the manufacturer for scrapping, unless the person operating the piece of equipment or another, delegated person is conducting the disposal. Our equipment falls under these regulations and is accordingly marked with the following symbol:



1.5 Product key

Decoding of the product description on the label, using an example:

PSE 9 080 - 510 3U zzz

										Field for identification of installed options and/or special models S01...S0x = Special models
										Construction (not stated everywhere) 3U = 19" frame with 3U
										Maximum current of the device in Ampere
										Maximum voltage of the device in Volt
										Series: 9 = Series 9000
										Type identification: PSE = Power Supply Extended, always programmable

1.6 Intended usage

The equipment is intended to be used, if a power supply or battery charger, only as a variable voltage and current source, or, if an electronic load, only as a variable current sink.

Typical application for a power supply is DC supply to any relevant user, for a battery charger the charging of various battery types and for electronic loads the replacement of an ohmic resistor by an adjustable DC current sink in order to load relevant voltage and current sources of any type.



- Claims of any sort due to damage caused by non-intended usage will not be accepted.
- All damage caused by non-intended usage is solely the responsibility of the operator.

1.7 Safety

1.7.1 Safety notices

Mortal danger - Hazardous voltage



- **Electrical equipment operation means that some parts can be under dangerous voltage. Therefore all parts under voltage must be covered! This basically applies to all models, though 40 V models according to SELV can not generate hazardous DC voltage!**
- **All work on connections must be carried out under zero voltage (output not connected to load) and may only be performed by qualified and informed persons. Improper actions can cause fatal injury as well as serious material damage!**
- **Never touch the contacts on DC output terminal directly after switching off the DC output, because there still can dangerous voltage present, sinking more or less slowly depending on the load! There also can be dangerous potential between negative DC output to PE or positive DC output to PE due to charged X capacitors, which don't discharge at all or only very slowly.**
- **Always follow 5 safety rules when configuring electric devices:**
 - **Disconnect completely**
 - **Secure against reconnection**
 - **Verify that the system is dead**
 - **Carry out earthing and short-circuiting**
 - **Provide protection from adjacent live parts**



- The equipment must only be used as intended
- The equipment is only approved for use within the connection limits stated on the product label.
- Do not insert any object, particularly metallic, through the ventilator slots
- Avoid any use of liquids near the equipment. Protect the device from wet, damp and condensation.
- For power supplies and battery chargers: do not connect users, particularly low resistance, to devices under power; sparking may occur which can cause burns as well as damage to the equipment and to the user.
- For electronic loads: do not connect power sources to equipment under power, sparking may occur which can cause burns as well as damage to the equipment and to the source.
- ESD regulations must be applied when plugging interface cards or modules into the relative slot
- Interface cards or modules may only be attached or removed after the device is switched off. It's not necessary to open the device.
- Do not connect external power sources with reversed polarity to DC inputs or outputs! The equipment will be damaged.
- For power supply devices: avoid where possible connecting external power sources to the DC output, and never those that can generate a higher voltage than the nominal voltage of the device.
- For electronic loads: do not connect a power source to the DC input which can generate a voltage more than 120% of the nominal input voltage of the load. The equipment isn't protected against over voltage and may be irreparably damaged.
- Never insert a network cable which is connected to Ethernet or its components into the master-slave socket on the back side of the device!
- Always configure the various protecting features against overvoltage, overpower etc. for sensitive loads to what the currently used application requires

1.7.2 Responsibility of the user

The equipment is in industrial operation. Therefore the operators are governed by the legal safety regulations. Alongside the warning and safety notices in this manual the relevant safety, accident prevention and environmental regulations must also be applied. In particular the users of the equipment:

- must be informed of the relevant job safety requirements
- must work to the defined responsibilities for operation, maintenance and cleaning of the equipment
- before starting work must have read and understood the operating manual
- must use the designated and recommended safety equipment.

1.7.3 Responsibility of the operator

Operator is any natural or legal person who uses the equipment or delegates the usage to a third party, and is responsible during its usage for the safety of the user, other personnel or third parties.

The equipment is in industrial operation. Therefore the operators are governed by the legal safety regulations. Alongside the warning and safety notices in this manual the relevant safety, accident prevention and environmental regulations must also be applied. In particular the operator has to

- be acquainted with the relevant job safety requirements
 - identify other possible dangers arising from the specific usage conditions at the work station via a risk assessment
 - introduce the necessary steps in the operating procedures for the local conditions
 - regularly control that the operating procedures are current
 - update the operating procedures where necessary to reflect changes in regulation, standards or operating conditions.
 - define clearly and unambiguously the responsibilities for operation, maintenance and cleaning of the equipment.
 - ensure that all employees who use the equipment have read and understood the manual. Furthermore the users are to be regularly schooled in working with the equipment and the possible dangers.
 - provide all personnel who work with the equipment with the designated and recommended safety equipment
- Furthermore, the operator is responsible for ensuring that the device is at all times technically fit for use.

1.7.4 User requirements

Any activity with equipment of this type may only be performed by persons who are able to work correctly and reliably and satisfy the requirements of the job.

- Persons whose reaction capability is negatively influenced by e. g. drugs, alcohol or medication may not operate the equipment.
- Age or job related regulations valid at the operating site must always be applied.



Danger for unqualified users

Improper operation can cause person or object damage. Only persons who have the necessary training, knowledge and experience may use the equipment.

Delegated persons are those who have been properly and demonstrably instructed in their tasks and the attendant dangers.

Qualified persons are those who are able through training, knowledge and experience as well as knowledge of the specific details to carry out all the required tasks, identify dangers and avoid personal and other risks.

1.7.5 Alarm signals

The equipment offers various possibilities for signaling alarm conditions, however, not for danger situations. The signals may be optical (on the display as text) acoustic (piezo buzzer) or electronic (pin/status output of an analog interface). All alarms will cause the device to switch off the DC output.

The meaning of the signals is as follows:

Signal OT (OverTemperature)	<ul style="list-style-type: none"> • Overheating of the device • DC output will be switched off temporarily • Non-critical
Signal OVP (OverVoltage)	<ul style="list-style-type: none"> • Overvoltage shutdown of the DC output due to high voltage entering the device or generated by the device itself due to a defect • Critical! The device and/or the load could be damaged
Signal OCP (OverCurrent)	<ul style="list-style-type: none"> • Shutdown of the DC output due to excess of the preset limit • Non-critical, protects the load from excessive current consumption
Signal OPP (OverPower)	<ul style="list-style-type: none"> • Shutdown of the DC output due to excess of the preset limit • Non-critical, protects the load from excessive power consumption
Signal PF (Power Fail)	<ul style="list-style-type: none"> • DC output shutdown due to AC undervoltage or defect of the AC input circuit • Critical on overvoltage! AC mains input circuit could take damage

1.8 Technical data

1.8.1 Approved operating conditions

- Use only inside dry buildings
- Ambient temperature 0-50°C (32-122 °F)
- Operational altitude: max. 2000 m (1.242 mi) above sea level
- Maximum 80% humidity, non-condensing

1.8.2 General technical data

Display: Color TFT display, 480pt x 128pt

Controls: 2 rotary knobs with button function, 6 pushbuttons

The nominal values for the device determine the maximum adjustable ranges.

1.8.3 Specific technical data (400 V models)

3.3 kW / 5 kW	Model 400 V				
	PSE 9040-170	PSE 9080-170	PSE 9200-70	PSE 9360-40	PSE 9500-30
AC Input					
Input voltage	400 V, ±15%, 45...66 Hz				
Input connection	2ph,PE				
Leak current	< 3.5 mA				
Power factor	> 0.99				
DC Output					
Max. output voltage U_{Max}	40 V	80 V	200 V	360 V	500 V
Max. output current I_{Max}	170 A	170 A	70 A	40 A	30 A
Max. output power P_{Max}	3.3 kW	5 kW	5 kW	5 kW	5 kW
Overvoltage protection range	0...44 V	0...88 V	0...220 V	0...396 V	0...550 V
Overcurrent protection range	0...187 A	0...187 A	0...77 A	0...44 A	0...33 A
Overpower protection range	0...3.63 kW	0...5.5 kW	0...5.5 kW	0...5.5 kW	0...5.5 kW
Temperature coefficient for set values Δ/K	Voltage / current: 100 ppm				
Output capacitance (approx.)	8500 μ F	8500 μ F	2500 μ F	400 μ F	250 μ F
Voltage regulation					
Adjustment range	0...40.8 V	0...81.6 V	0...204 V	0...367.2 V	0...510 V
Accuracy ⁽¹⁾ (at 23 ± 5°C / 73±9 °F)	< 0.1% U_{Max}	< 0.1% U_{Max}	< 0.1% U_{Max}	< 0.1% U_{Max}	< 0.1% U_{Max}
Line regulation at ±10% ΔU_{AC}	< 0.02% U_{Max}	< 0.02% U_{Max}	< 0.02% U_{Max}	< 0.02% U_{Max}	< 0.02% U_{Max}
Load regulation at 0...100% load	< 0.05% U_{Max}	< 0.05% U_{Max}	< 0.05% U_{Max}	< 0.05% U_{Max}	< 0.05% U_{Max}
Rise time 10...90% ΔU	Max. 30 ms	Max. 30 ms	Max. 30 ms	Max. 30 ms	Max. 30 ms
Settling time after load step	< 1.5 ms	< 1.5 ms	< 1.5 ms	< 1.5 ms	< 1.5 ms
Display: Resolution	See section „1.9.6.4. Resolution of the displayed values“				
Display: Accuracy ⁽⁴⁾	≤ 0.2% U_{Max}	≤ 0.2% U_{Max}	≤ 0.2% U_{Max}	≤ 0.2% U_{Max}	≤ 0.2% U_{Max}
Ripple ⁽²⁾	< 200 mV _{PP} < 16 mV _{RMS}	< 200 mV _{PP} < 16 mV _{RMS}	< 300 mV _{PP} < 40 mV _{RMS}	< 550 mV _{PP} < 65 mV _{RMS}	< 350 mV _{PP} < 70 mV _{RMS}
Remote sensing compensation	Max. 5% U_{Max}	Max. 5% U_{Max}	Max. 5% U_{Max}	Max. 5% U_{Max}	Max. 5% U_{Max}
Fall time at no load after switching DC output off	-	Down from 100% to <60 V: less than 10 s			
Current regulation					
Adjustment range	0...173.4 A	0...173.4 A	0...71.4 A	0...40.8 A	0...30.6 A
Accuracy ⁽¹⁾ (at 23 ± 5°C / 73±9 °F)	< 0.2% I_{Max}	< 0.2% I_{Max}	< 0.2% I_{Max}	< 0.2% I_{Max}	< 0.2% I_{Max}
Line regulation at ±10% ΔU_{AC}	< 0.05% I_{Max}	< 0.05% I_{Max}	< 0.05% I_{Max}	< 0.05% I_{Max}	< 0.05% I_{Max}
Load regulation at 0...100% ΔU_{OUT}	< 0.15% I_{Max}	< 0.15% I_{Max}	< 0.15% I_{Max}	< 0.15% I_{Max}	< 0.15% I_{Max}
Ripple ⁽²⁾	< 80 mA _{RMS}	< 80 mA _{RMS}	< 22 mA _{RMS}	< 5.2 mA _{RMS}	< 16 mA _{RMS}
Display: Resolution	See section „1.9.6.4. Resolution of the displayed values“				
Display: Accuracy ⁽⁴⁾	≤ 0.2% I_{Max}	≤ 0.2% I_{Max}	≤ 0.2% I_{Max}	≤ 0.2% I_{Max}	≤ 0.2% I_{Max}
Power regulation					
Adjustment range	0...3.37 kW	0...5.1 kW	0...5.1 kW	0...5.1 kW	0...5.1 kW
Accuracy ⁽¹⁾ (at 23 ± 5°C / 73±9 °F)	< 1% P_{Max}	< 1% P_{Max}	< 1% P_{Max}	< 1% P_{Max}	< 1% P_{Max}
Line regulation at ±10% ΔU_{AC}	< 0.05% P_{Max}	< 0.05% P_{Max}	< 0.05% P_{Max}	< 0.05% P_{Max}	< 0.05% P_{Max}
Load reg. at 10-90% ΔU_{OUT} * ΔI_{OUT}	< 0.75% P_{Max}	< 0.75% P_{Max}	< 0.75% P_{Max}	< 0.75% P_{Max}	< 0.75% P_{Max}
Display: Resolution	See section „1.9.6.4. Resolution of the displayed values“				
Display: Accuracy ⁽⁴⁾	≤ 0.75% P_{Max}	≤ 0.8% P_{Max}	≤ 0.8% P_{Max}	≤ 0.8% P_{Max}	≤ 0.8% P_{Max}
Efficiency ⁽³⁾	≈ 93%	≈ 93%	≈ 95%	≈ 95%	≈ 95,5%

(1) Related to the nominal values, the accuracy defines the maximum deviation between an adjusted values and the true (actual) value on the DC output. Example: a 80 V model has min. 0.1% voltage accuracy, that is 80 mV. When adjusting the voltage to 5 V, the actual value is allowed to differ max. 80 mV, which means it might be between 4.92 V and 5.08 V.

(2) RMS value: LF 0...300 kHz, PP value: HF 0...20MHz

(3) Typical value at 100% output voltage and 100% power

(4) The display error adds to the error of the related actual value on the DC output

3.3 kW / 5 kW	Model 400 V					
	PSE 9040-170	PSE 9080-170	PSE 9200-70	PSE 9360-40	PSE 9500-30	
Analog interface ⁽¹⁾						
Set value inputs	U, I, P					
Actual value output	U, I					
Control signals	DC output on/off, remote control on/off					
Status signals	CV, OVP, OCP, OPP, OT, PF, DC output on/off					
Insulation						
Allowed float (potential shift) on the DC output:						
Negative terminal to PE	Max.	±400 V DC	±400 V DC	±400 V DC	±400 V DC	±725 V DC
Positive terminal to PE	Max.	±400 V DC	±400 V DC	±600 V DC	±600 V DC	±1000 V DC
Miscellaneous						
Cooling	Temperature controlled fans, front inlet, rear exhaust					
Ambient temperature	0..50°C (32...122°F)					
Storage temperature	-20...70°C (-4...158°F)					
Humidity	< 80%, not condensing					
Standards	IEC 61010-1 (2010), IEC 61000-6-2 (2005), IEC 61000-6-3 (2006)					
Overvoltage category	2					
Protection class	1					
Pollution degree	2					
Operational altitude	< 2000 m (1.242 mi)					
Digital interfaces						
Featured	1x USB-B for communication					
Slot	Various interface modules for CAN, CANopen, Ethernet, Profibus, Profinet, ModBus TCP, EtherCAT or RS232					
Terminals						
Rear side	Share Bus, DC output, AC input, remote sensing, analog interface, USB-B, master-slave bus, interface module slot					
Dimensions						
Enclosure (WxHxD)	19" x 3U x 609 mm (24")					
Total (WxHxD)	483 x 133 x 714 mm (19" x 5.2" x 28.1")					
Weight	≈17 kg (37.6 lb)	≈17 kg (37.6 lb)	≈17 kg (37.6 lb)	≈17 kg (37.6 lb)	≈17 kg (37.6 lb)	
Article number	06230700	06230701	06230702	06230703	06230704	

(1 For technical specifications of the analog interface see „3.5.4.4 Analog interface specification“ on page 52

5 kW / 6.6 kW / 10 kW	<i>Model 400 V</i>				
	<i>PSE 9750-20</i>	<i>PSE 9040-340</i>	<i>PSE 9040-510</i>	<i>PSE 9080-340</i>	<i>PSE 9200-140</i>
AC Input					
Input voltage	400 V, ±15%, 45...66 Hz				
Input connection	2ph,PE	3ph,PE	3ph,PE	3ph,PE	3ph,PE
Input fuse (internal)	< 3.5 mA				
Leak current	> 0.99				
Power factor					
DC Output					
Max. output voltage U_{Max}	750 V	40 V	40 V	80 V	200 V
Max. output current I_{Max}	20 A	340 A	510 A	340 A	140 A
Max. output power P_{Max}	5 kW	6.6 kW	10 kW	10 kW	10 kW
Overvoltage protection range	0...825 V	0...44 V	0...44 V	0...88 V	0...220 V
Overcurrent protection range	0...22 A	0...374 A	0...561 A	0...374 A	0...154 A
Overpower protection range	0...5.5 kW	0...7.26 kW	0...11 kW	0...11 kW	0...11 kW
Temperature coefficient for set values Δ/K	Voltage / current: 100 ppm				
Output capacitance (approx.)	100 μ F	16900 μ F	25380 μ F	16900 μ F	5040 μ F
Voltage regulation					
Adjustment range	0...765 V	0...40.8 V	0...40.8 V	0...81.6 V	0...204 V
Accuracy ⁽¹⁾ (at 23 ± 5°C / 73±9 °F)	< 0.1% U_{Max}	< 0.1% U_{Max}	< 0.1% U_{Max}	< 0.1% U_{Max}	< 0.1% U_{Max}
Line regulation at ±10% ΔU_{AC}	< 0.02% U_{Max}	< 0.02% U_{Max}	< 0.02% U_{Max}	< 0.02% U_{Max}	< 0.02% U_{Max}
Load regulation at 0...100% load	< 0.05% U_{Max}	< 0.05% U_{Max}	< 0.05% U_{Max}	< 0.05% U_{Max}	< 0.05% U_{Max}
Rise time 10...90% ΔU	Max. 30 ms	Max. 30 ms	Max. 30 ms	Max. 30 ms	Max. 30 ms
Settling time after load step	< 1.5 ms	< 1.5 ms	< 1.5 ms	< 1.5 ms	< 1.5 ms
Display: Resolution	See section „1.9.6.4. Resolution of the displayed values“				
Display: Accuracy ⁽⁴⁾	≤ 0.2% U_{Max}	≤ 0.2% U_{Max}	≤ 0.2% U_{Max}	≤ 0.2% U_{Max}	≤ 0.2% U_{Max}
Ripple ⁽²⁾	< 800 mV _{PP} < 200 mV _{RMS}	< 320 mV _{PP} < 25 mV _{RMS}	< 320 mV _{PP} < 25 mV _{RMS}	< 320 mV _{PP} < 25 mV _{RMS}	< 300 mV _{PP} < 40 mV _{RMS}
Remote sensing compensation	Max. 5% U_{Max}	Max. 5% U_{Max}	Max. 5% U_{Max}	Max. 5% U_{Max}	Max. 5% U_{Max}
Fall time at no load after switching DC output off	Down from 100% to <60 V: less than 10 s	-	-	Down from 100% to <60 V: less than 10 s	Down from 100% to <60 V: less than 10 s
Current regulation					
Adjustment range	0...20.4 A	0...346.8 A	0...520.2 A	0...346.8 A	0...142.8 A
Accuracy ⁽¹⁾ (at 23 ± 5°C / 73±9 °F)	< 0.2% I_{Max}	< 0.2% I_{Max}	< 0.2% I_{Max}	< 0.2% I_{Max}	< 0.2% I_{Max}
Line regulation at ±10% ΔU_{AC}	< 0.05% I_{Max}	< 0.05% I_{Max}	< 0.05% I_{Max}	< 0.05% I_{Max}	< 0.05% I_{Max}
Load regulation at 0...100% ΔU_{OUT}	< 0.15% I_{Max}	< 0.15% I_{Max}	< 0.15% I_{Max}	< 0.15% I_{Max}	< 0.15% I_{Max}
Ripple ⁽²⁾	< 16 mA _{RMS}	< 160 mA _{RMS}	< 120 mA _{RMS}	< 160 mA _{RMS}	< 44 mA _{RMS}
Display: Resolution	See section „1.9.6.4. Resolution of the displayed values“				
Display: Accuracy ⁽⁴⁾	≤ 0.2% I_{Max}	≤ 0.2% I_{Max}	≤ 0.2% I_{Max}	≤ 0.2% I_{Max}	≤ 0.2% I_{Max}
Power regulation					
Adjustment range	0...5.1 kW	0...6.73 kW	0...10.2 kW	0...10.2 kW	0...10.2 kW
Accuracy ⁽¹⁾ (at 23 ± 5°C / 73±9 °F)	< 1% P_{Max}	< 1% P_{Max}	< 1% P_{Max}	< 1% P_{Max}	< 1% P_{Max}
Line regulation at ±10% ΔU_{AC}	< 0.05% P_{Max}	< 0.05% P_{Max}	< 0.05% P_{Max}	< 0.05% P_{Max}	< 0.05% P_{Max}
Load reg. at 10-90% ΔU_{OUT} * ΔI_{OUT}	< 0.75% P_{Max}	< 0.75% P_{Max}	< 0.75% P_{Max}	< 0.75% P_{Max}	< 0.75% P_{Max}
Display: Resolution	See section „1.9.6.4. Resolution of the displayed values“				
Display: Accuracy ⁽⁴⁾	≤ 0.8% P_{Max}	≤ 0.7% P_{Max}	≤ 0.7% P_{Max}	≤ 0.8% P_{Max}	≤ 0.85% P_{Max}
Efficiency ⁽³⁾	≈ 94%	≈ 93%	≈ 93%	≈ 93%	≈ 95%

(1) Related to the nominal values, the accuracy defines the maximum deviation between an adjusted values and the true (actual) value on the DC output. Example: a 80 V model has min. 0.1% voltage accuracy, that is 80 mV. When adjusting the voltage to 5 V, the actual value is allowed to differ max. 80 mV, which means it might be between 4.92 V and 5.08 V.

(2) RMS value: LF 0...300 kHz, PP value: HF 0...20MHz

(3) Typical value at 100% output voltage and 100% power

(4) The display error adds to the error of the related actual value on the DC output

5 kW / 6.6 kW / 10 kW	<i>Model 400 V</i>					
	<i>PSE 9750-20</i>	<i>PSE 9040-340</i>	<i>PSE 9040-510</i>	<i>PSE 9080-340</i>	<i>PSE 9200-140</i>	
Analog interface ⁽¹⁾						
Set value inputs	U, I, P					
Actual value output	U, I					
Control signals	DC output on/off, remote control on/off					
Status signals	CV, OVP, OCP, OPP, OT, PF, DC output on/off					
Insulation						
Allowed float (potential shift) on the DC output:						
Negative terminal to PE	Max.	±725 V DC	±400 V DC	±400 V DC	±400 V DC	±400 V DC
Positive terminal to PE	Max.	±1000 V DC	±400 V DC	±400 V DC	±400 V DC	±600 V DC
Miscellaneous						
Cooling	Temperature controlled fans, front inlet, rear exhaust					
Ambient temperature	0..50°C (32...122°F)					
Storage temperature	-20...70°C (-4...158°F)					
Humidity	< 80%, not condensing					
Standards	IEC 61010-1 (2010), IEC 61000-6-2 (2005), IEC 61000-6-3 (2006)					
Overvoltage category	2					
Protection class	1					
Pollution degree	2					
Operational altitude	< 2000 m (1.242 mi)					
Digital interfaces						
Featured	1x USB-B for communication					
Slot	Various interface modules for CAN, CANopen, Ethernet, Profibus, Profinet, ModBus TCP, EtherCAT or RS232					
Terminals						
Rear side	Share Bus, DC output, AC input, remote sensing, analog interface, USB-B, master-slave bus, interface module slot					
Dimensions						
Enclosure (WxHxD)	19" x 3U x 609 mm (24")					
Total (WxHxD)	483 x 133 x 714 mm (19" x 5.2" x 28.1")					
Weight	≈17 kg (37.6 lb)	≈24 kg (52.9 lb)	≈30 kg (66.1 lb)	≈24 kg (52.9 lb)	≈24 kg (52.9 lb)	
Article number	06230705	06230706	06230707	06230708	06230709	

(1 For technical specifications of the analog interface see „3.5.4.4 Analog interface specification“ on page 52

10 kW / 15 kW	Model 400 V				
	PSE 9360-80	PSE 9500-60	PSE 9750-40	PSE 91000-30	PSE 9080-510
AC Input					
Input voltage	400 V, $\pm 15\%$, 45...66 Hz				
Input connection	3ph, PE				
Input fuse (internal)	< 3.5 mA				
Leak current	> 0.99				
Power factor					
DC Output					
Max. output voltage U_{Max}	360 V	500 V	750 V	1000 V	80 V
Max. output current I_{Max}	80 A	60 A	40 A	30 A	510 A
Max. output power P_{Max}	10 kW	10 kW	10 kW	10 kW	15 kW
Overvoltage protection range	0...396 V	0...550 V	0...825 V	0...1100 V	0...88 V
Overcurrent protection range	0...88 A	0...66 A	0...44 A	0...33 A	0...561 A
Overpower protection range	0...11 kW	0...11 kW	0...11 kW	0...11 kW	0...16.5 kW
Temperature coefficient for set values Δ/K	Voltage / current: 100 ppm				
Output capacitance (approx.)	800 μ F	500 μ F	210 μ F	127 μ F	25380 μ F
Voltage regulation					
Adjustment range	0...367.2 V	0...510 V	0...765 V	0...1020 V	0...81.6 V
Accuracy ⁽¹⁾ (at 23 \pm 5°C / 73 \pm 9 °F)	< 0.1% U_{Max}	< 0.1% U_{Max}	< 0.1% U_{Max}	< 0.1% U_{Max}	< 0.1% U_{Max}
Line regulation at $\pm 10\%$ ΔU_{AC}	< 0.02% U_{Max}	< 0.02% U_{Max}	< 0.02% U_{Max}	< 0.02% U_{Max}	< 0.02% U_{Max}
Load regulation at 0...100% load	< 0.05% U_{Max}	< 0.05% U_{Max}	< 0.05% U_{Max}	< 0.05% U_{Max}	< 0.05% U_{Max}
Rise time 10...90% ΔU	Max. 30 ms	Max. 30 ms	Max. 30 ms	Max. 30 ms	Max. 30 ms
Settling time after load step	< 1.5 ms	< 1.5 ms	< 1.5 ms	< 1.5 ms	< 2 ms
Display: Resolution	See section „1.9.6.4. Resolution of the displayed values“				
Display: Accuracy ⁽⁴⁾	$\leq 0.2\%$ U_{Max}	$\leq 0.2\%$ U_{Max}	$\leq 0.2\%$ U_{Max}	$\leq 0.2\%$ U_{Max}	$\leq 0.2\%$ U_{Max}
Ripple ⁽²⁾	< 550 mV _{PP} < 65 mV _{RMS}	< 350 mV _{PP} < 70 mV _{RMS}	< 800 mV _{PP} < 200 mV _{RMS}	< 1600 mV _{PP} < 350 mV _{RMS}	< 320 mV _{PP} < 25 mV _{RMS}
Remote sensing compensation	Max. 5% U_{Max}	Max. 5% U_{Max}	Max. 5% U_{Max}	Max. 5% U_{Max}	Max. 5% U_{Max}
Fall time at no load after switching DC output off	Down from 100% to <60 V: less than 10 s				
Current regulation					
Adjustment range	0...81.6 A	0...61.2 A	0...40.8 A	0...30.6 A	0...520.2 A
Accuracy ⁽¹⁾ (at 23 \pm 5°C / 73 \pm 9 °F)	< 0.2% I_{Max}	< 0.2% I_{Max}	< 0.2% I_{Max}	< 0.2% I_{Max}	< 0.2% I_{Max}
Line regulation at $\pm 10\%$ ΔU_{AC}	< 0.05% I_{Max}	< 0.05% I_{Max}	< 0.05% I_{Max}	< 0.05% I_{Max}	< 0.05% I_{Max}
Load regulation at 0...100% ΔU_{OUT}	< 0.15% I_{Max}	< 0.15% I_{Max}	< 0.15% I_{Max}	< 0.15% I_{Max}	< 0.15% I_{Max}
Ripple ⁽²⁾	< 10.4 mA _{RMS}	< 32 mA _{RMS}	< 32 mA _{RMS}	< 22 mA _{RMS}	< 240 mA _{RMS}
Display: Resolution	See section „1.9.6.4. Resolution of the displayed values“				
Display: Accuracy ⁽⁴⁾	$\leq 0.2\%$ I_{Max}	$\leq 0.2\%$ I_{Max}	$\leq 0.2\%$ I_{Max}	$\leq 0.2\%$ I_{Max}	$\leq 0.2\%$ I_{Max}
Power regulation					
Adjustment range	0...10.2 kW	0...10.2 kW	0...10.2 kW	0...10.2 kW	0...15.3 kW
Accuracy ⁽¹⁾ (at 23 \pm 5°C / 73 \pm 9 °F)	< 1% P_{Max}	< 1% P_{Max}	< 1% P_{Max}	< 1% P_{Max}	< 1% P_{Max}
Line regulation at $\pm 10\%$ ΔU_{AC}	< 0.05% P_{Max}	< 0.05% P_{Max}	< 0.05% P_{Max}	< 0.05% P_{Max}	< 0.05% P_{Max}
Load reg. at 10-90% ΔU_{OUT} * ΔI_{OUT}	< 0.75% P_{Max}	< 0.75% P_{Max}	< 0.75% P_{Max}	< 0.75% P_{Max}	< 0.75% P_{Max}
Display: Resolution	See section „1.9.6.4. Resolution of the displayed values“				
Display: Accuracy ⁽⁴⁾	$\leq 0.8\%$ P_{Max}	$\leq 0.85\%$ P_{Max}	$\leq 0.85\%$ P_{Max}	$\leq 0.85\%$ P_{Max}	$\leq 0.8\%$ P_{Max}
Efficiency ⁽³⁾	$\approx 93\%$	$\approx 95\%$	$\approx 94\%$	$\approx 95\%$	$\approx 93\%$

(1) Related to the nominal values, the accuracy defines the maximum deviation between an adjusted values and the true (actual) value on the DC output. Example: a 80 V model has min. 0.1% voltage accuracy, that is 80 mV. When adjusting the voltage to 5 V, the actual value is allowed to differ max. 80 mV, which means it might be between 4.92 V and 5.08 V.

(2) RMS value: LF 0...300 kHz, PP value: HF 0...20MHz

(3) Typical value at 100% output voltage and 100% power

(4) The display error adds to the error of the related actual value on the DC output

10 kW / 15 kW	<i>Model 400 V</i>					
	<i>PSE 9360-80</i>	<i>PSE 9500-60</i>	<i>PSE 9750-40</i>	<i>PSE 91000-30</i>	<i>PSE 9080-510</i>	
Analog interface ⁽¹⁾						
Set value inputs	U, I, P					
Actual value output	U, I					
Control signals	DC output on/off, remote control on/off					
Status signals	CV, OVP, OCP, OPP, OT, PF, DC output on/off					
Insulation						
Allowed float (potential shift) on the DC output:						
Negative terminal to PE	Max.	±400 V DC	±725 V DC	±725 V DC	±1000 V DC	±400 V DC
Positive terminal to PE	Max.	±600 V DC	±1000 V DC	±1000 V DC	±1500 V DC	±400 V DC
Miscellaneous						
Cooling	Temperature controlled fans, front inlet, rear exhaust					
Ambient temperature	0..50°C (32...122°F)					
Storage temperature	-20...70°C (-4...158°F)					
Humidity	< 80%, not condensing					
Standards	IEC 61010-1 (2010), IEC 61000-6-2 (2005), IEC 61000-6-3 (2006)					
Overvoltage category	2					
Protection class	1					
Pollution degree	2					
Operational altitude	< 2000 m (1.242 mi)					
Digital interfaces						
Featured	1x USB-B for communication					
Slot	Various interface modules for CAN, CANopen, Ethernet, Profibus, Profinet, ModBus TCP, EtherCAT or RS232					
Terminals						
Rear side	Share Bus, DC output, AC input, remote sensing, analog interface, USB-B, master-slave bus, interface module slot					
Dimensions						
Enclosure (WxHxD)	19" x 3U x 609 mm (24")					
Total (WxHxD)	483 x 133 x 714 mm (19" x 5.2" x 28.1")					
Weight	≈24 kg (52.9 lb)	≈24 kg (52.9 lb)	≈24 kg (52.9 lb)	≈24 kg (52.9 lb)	≈30 kg (66.1 lb)	
Article number	06230710	06230711	06230712	06230713	06230714	

(1 For technical specifications of the analog interface see „3.5.4.4 Analog interface specification“ on page 52

15 kW	<i>Model 400 V</i>				
	<i>PSE 9200-210</i>	<i>PSE 9360-120</i>	<i>PSE 9500-90</i>	<i>PSE 9750-60</i>	<i>PSE 91500-30</i>
AC Input					
Input voltage	400 V, ±15%, 45...66 Hz				
Input connection	3ph,PE				
Leak current	< 3.5 mA				
Power factor	> 0.99				
DC Output					
Max. output voltage U_{Max}	200 V	360 V	500 V	750 V	1500 V
Max. output current I_{Max}	210 A	120 A	90 A	60 A	30 A
Max. output power P_{Max}	15 kW	15 kW	15 kW	15 kW	15 kW
Overvoltage protection range	0...220 V	0...396 V	0...550 V	0...825 V	0...1650 V
Overcurrent protection range	0...231 A	0...132 A	0...99 A	0...66 A	0...33 A
Overpower protection range	0...16.5 kW	0...16.5 kW	0...16.5 kW	0...16.5 kW	0...16.5 kW
Temperature coefficient for set values Δ/K	Voltage / current: 100 ppm				
Output capacitance (approx.)	7560 μ F	1200 μ F	760 μ F	310 μ F	84 μ F
Voltage regulation					
Adjustment range	0...204 V	0...367.2 V	0...510 V	0...765 V	0...1530 V
Accuracy ⁽¹⁾ (at 23 ± 5°C / 73±9 °F)	< 0.1% U_{Max}	< 0.1% U_{Max}	< 0.1% U_{Max}	< 0.1% U_{Max}	< 0.1% U_{Max}
Line regulation at ±10% ΔU_{AC}	< 0.02% U_{Max}	< 0.02% U_{Max}	< 0.02% U_{Max}	< 0.02% U_{Max}	< 0.02% U_{Max}
Load regulation at 0...100% load	< 0.05% U_{Max}	< 0.05% U_{Max}	< 0.05% U_{Max}	< 0.05% U_{Max}	< 0.05% U_{Max}
Rise time 10...90% ΔU	Max. 30 ms	Max. 30 ms	Max. 30 ms	Max. 30 ms	Max. 30 ms
Settling time after load step	< 2 ms	< 2 ms	< 2 ms	< 2 ms	< 2 ms
Display: Resolution	See section „1.9.6.4. Resolution of the displayed values“				
Display: Accuracy ⁽⁴⁾	≤ 0.2% U_{Max}	≤ 0.2% U_{Max}	≤ 0.2% U_{Max}	≤ 0.2% U_{Max}	≤ 0.2% U_{Max}
Ripple ⁽²⁾	< 300 mV _{PP} < 40 mV _{RMS}	< 550 mV _{PP} < 65 mV _{RMS}	< 350 mV _{PP} < 70 mV _{RMS}	< 800 mV _{PP} < 200 mV _{RMS}	< 2400 mV _{PP} < 400 mV _{RMS}
Remote sensing compensation	Max. 5% U_{Max}	Max. 5% U_{Max}	Max. 5% U_{Max}	Max. 5% U_{Max}	Max. 5% U_{Max}
Fall time at no load after switching DC output off	Down from 100% to <60 V: less than 10 s				
Current regulation					
Adjustment range	0...214.2 A	0...122.4 A	0...91.8 A	0...61.2 A	0...30.6 A
Accuracy ⁽¹⁾ (at 23 ± 5°C / 73±9 °F)	< 0.2% I_{Max}	< 0.2% I_{Max}	< 0.2% I_{Max}	< 0.2% I_{Max}	< 0.2% I_{Max}
Line regulation at ±10% ΔU_{AC}	< 0.05% I_{Max}	< 0.05% I_{Max}	< 0.05% I_{Max}	< 0.05% I_{Max}	< 0.05% I_{Max}
Load regulation at 0...100% ΔU_{OUT}	< 0.15% I_{Max}	< 0.15% I_{Max}	< 0.15% I_{Max}	< 0.15% I_{Max}	< 0.15% I_{Max}
Ripple ⁽²⁾	< 66 mA _{RMS}	< 15.6 mA _{RMS}	< 48 mA _{RMS}	< 48 mA _{RMS}	< 26 mA _{RMS}
Display: Resolution	See section „1.9.6.4. Resolution of the displayed values“				
Display: Accuracy ⁽⁴⁾	≤ 0.2% I_{Max}	≤ 0.2% I_{Max}	≤ 0.2% I_{Max}	≤ 0.2% I_{Max}	≤ 0.2% I_{Max}
Power regulation					
Adjustment range	0...15.3 kW	0...15.3 kW	0...15.3 kW	0...15.3 kW	0...15.3 kW
Accuracy ⁽¹⁾ (at 23 ± 5°C / 73±9 °F)	< 1% P_{Max}	< 1% P_{Max}	< 1% P_{Max}	< 1% P_{Max}	< 1% P_{Max}
Line regulation at ±10% ΔU_{AC}	< 0.05% P_{Max}	< 0.05% P_{Max}	< 0.05% P_{Max}	< 0.05% P_{Max}	< 0.05% P_{Max}
Load reg. at 10-90% ΔU_{OUT} * ΔI_{OUT}	< 0.75% P_{Max}	< 0.75% P_{Max}	< 0.75% P_{Max}	< 0.75% P_{Max}	< 0.75% P_{Max}
Display: Resolution	See section „1.9.6.4. Resolution of the displayed values“				
Display: Accuracy ⁽⁴⁾	≤ 0.8% P_{Max}	≤ 0.85% P_{Max}	≤ 0.85% P_{Max}	≤ 0.85% P_{Max}	≤ 0.85% P_{Max}
Efficiency ⁽³⁾	≈ 95%	≈ 94%	≈ 95%	≈ 94%	≈ 95%

(1) Related to the nominal values, the accuracy defines the maximum deviation between an adjusted values and the true (actual) value on the DC output. Example: a 80 V model has min. 0.1% voltage accuracy, that is 80 mV. When adjusting the voltage to 5 V, the actual value is allowed to differ max. 80 mV, which means it might be between 4.92 V and 5.08 V.

(2) RMS value: LF 0...300 kHz, PP value: HF 0...20MHz

(3) Typical value at 100% output voltage and 100% power

(4) The display error adds to the error of the related actual value on the DC output

15 kW	<i>Model 400 V</i>					
	<i>PSE 9200-210</i>	<i>PSE 9360-120</i>	<i>PSE 9500-90</i>	<i>PSE 9750-60</i>	<i>PSE 91500-30</i>	
Analog interface ⁽¹⁾						
Set value inputs	U, I, P					
Actual value output	U, I					
Control signals	DC output on/off, remote control on/off					
Status signals	CV, OVP, OCP, OPP, OT, PF, DC output on/off					
Insulation						
Allowed float (potential shift) on the DC output:						
Negative terminal to PE	Max.	±400 V DC	±400 V DC	±725 V DC	±725 V DC	±1500 V DC
Positive terminal to PE	Max.	±600 V DC	±600 V DC	±1000 V DC	±1000 V DC	±1800 V DC
Miscellaneous						
Cooling	Temperature controlled fans, front inlet, rear exhaust					
Ambient temperature	0..50°C (32...122°F)					
Storage temperature	-20...70°C (-4...158°F)					
Humidity	< 80%, not condensing					
Standards	IEC 61010-1 (2010), IEC 61000-6-2 (2005), IEC 61000-6-3 (2006)					
Overvoltage category	2					
Protection class	1					
Pollution degree	2					
Operational altitude	< 2000 m (1.242 mi)					
Digital interfaces						
Featured	1x USB-B for communication					
Slot	Various interface modules for CAN, CANopen, Ethernet, Profibus, Profinet, ModBus TCP, EtherCAT or RS232					
Terminals						
Rear side	Share Bus, DC output, AC input, remote sensing, analog interface, USB-B, master-slave bus, interface module slot					
Dimensions						
Enclosure (WxHxD)	19" x 3U x 609 mm (24")					
Total (WxHxD)	483 x 133 x 714 mm (19" x 5.2" x 28.1")					
Weight	≈30 kg (66.1 lb)	≈30 kg (66.1 lb)	≈30 kg (66.1 lb)	≈30 kg (66.1 lb)	≈30 kg (66.1 lb)	
Article number	06230715	06230716	06230717	06230715	06230719	

(1 For technical specifications of the analog interface see „3.5.4.4 Analog interface specification“ on page 52

1.8.4 Specific technical data (208 V models)

The 208 V models are derivations from the standard 400 V models, intended to be used in countries where 208 V three-phase supply (120 V grid) is typical, such as North America or Japan. They only differ in a few technical specifications, which are listed below. The remaining specifications are listed in 1.8.3.

5 kW	Model 208 V		
	PSE 9360-40		
AC supply			
Voltage range (L-L), frequency	208 V AC, $\pm 10\%$, 45 - 66 Hz		
Connection	2ph, PE		
Phase current	Max. 53 A		
DC Power rating	5 kW		
Dimensions			
Enclosure (WxHxD)	19" x 3U x 682 mm (24")		
Total (WxHxD)	483 x 133 x 785 mm (19" x 5.2" x 30.9")		
Weight	≈ 17 kg (37.6 lb)		
Article number	06238703		

10 kW / 15 kW	Model 208 V		
	PSE 9080-340	PSE 9080-510	PSE 9200-210
AC supply			
Voltage range (L-L), frequency	208 V AC, $\pm 10\%$, 45 - 66 Hz		
Connection	3ph, PE	3ph, PE	3ph, PE
Phase current	Max. 53 A	Max. 53 A	Max. 53 A
DC Power rating	10 kW	15 kW	15 kW
Dimensions			
Enclosure (WxHxD)	19" x 3U x 682 mm (24")		
Total (WxHxD)	483 x 133 x 785 mm (19" x 5.2" x 30.9")		
Weight	≈ 25 kg (55.1 lb)	≈ 31 kg (68.3 lb)	≈ 31 kg (68.3 lb)
Article number	06238708	06238714	06238715

15 kW	Model 208 V		
	PSE 9500-90	PSE 91000-40	
AC supply			
Voltage range (L-L), frequency	208 V AC, $\pm 10\%$, 45 - 66 Hz		
Connection	3ph, PE	3ph, PE	
Phase current	Max. 53 A	Max. 53 A	
DC Power rating	15 kW	15 kW	
Dimensions			
Enclosure (WxHxD)	19" x 3U x 682 mm (24")		
Total (WxHxD)	483 x 133 x 785 mm (19" x 5.2" x 30.9")		
Weight	≈ 31 kg (68.3 lb)	≈ 31 kg (68.3 lb)	
Article number	06238717	06238720	

1.8.5 Views

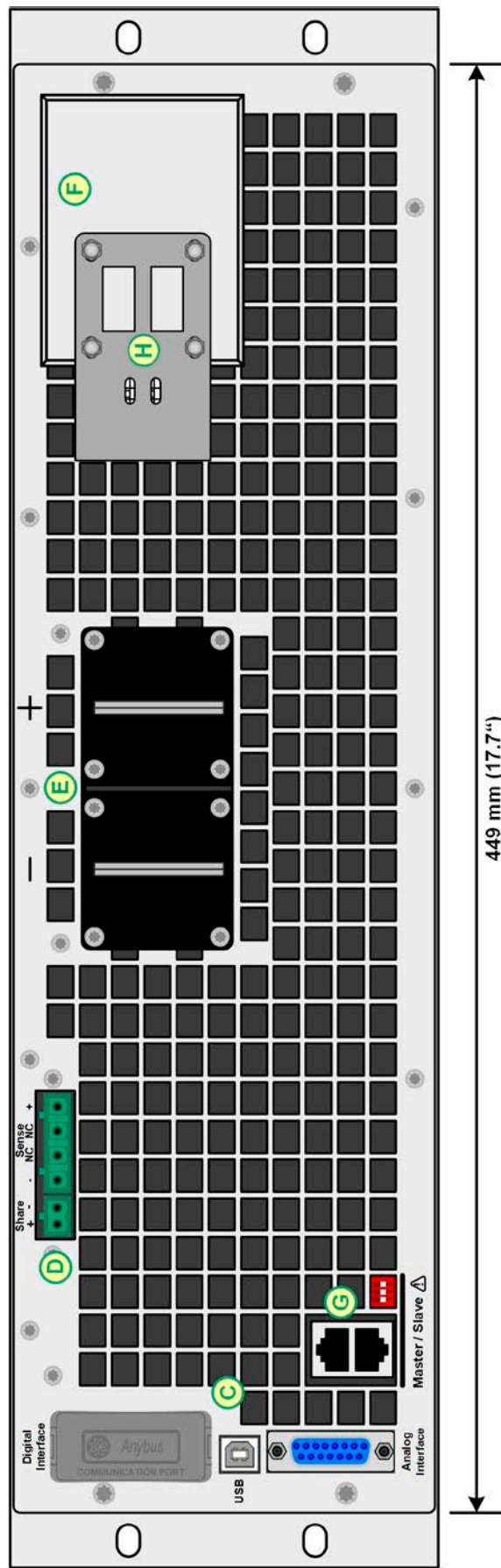
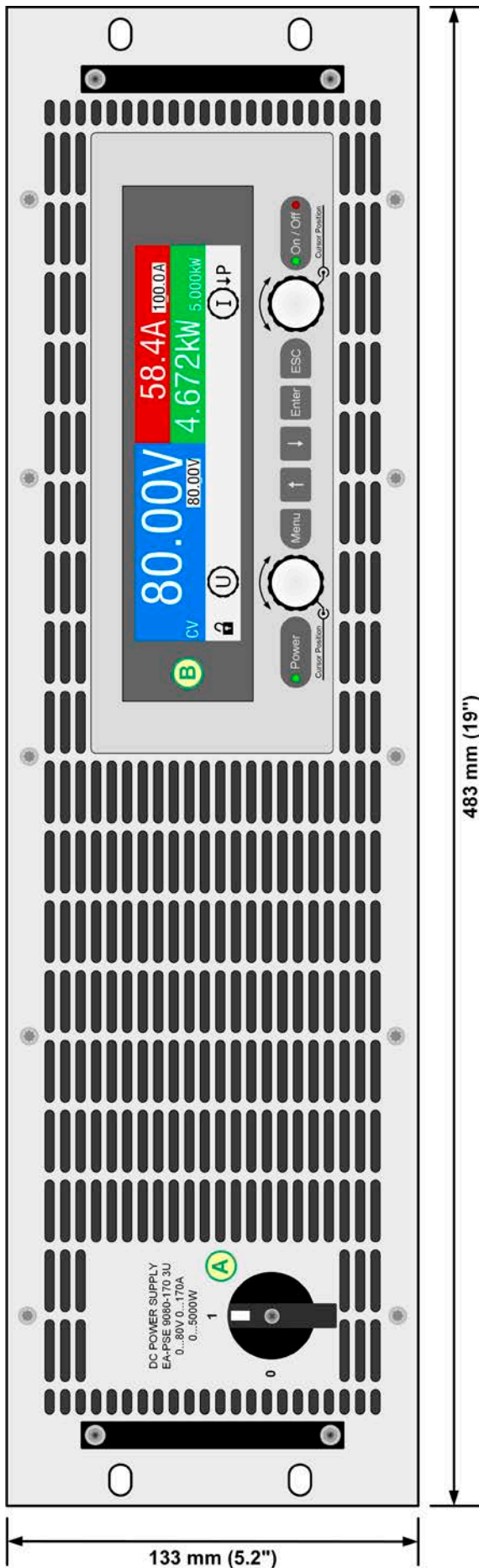

- A - Power switch
- B - Control panel
- C - Control interfaces (digital, analog)
- D - Share Bus and remote sensing connection
- E - DC output (view shows terminal type 1)
- F - AC input connection (showing EU model connector)
- G - Master-slave ports
- H - Plug fixture & strain relief

Figure 1 - Front side

Figure 2 - Back side (showing 400 V version)



Figure 3 Side view from left

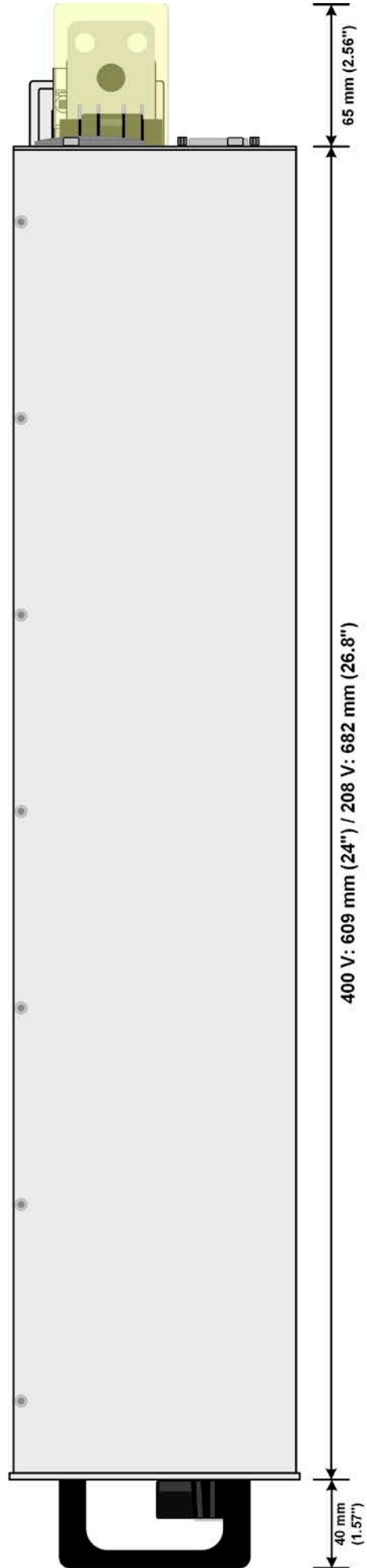

Figure 4 Side view from right

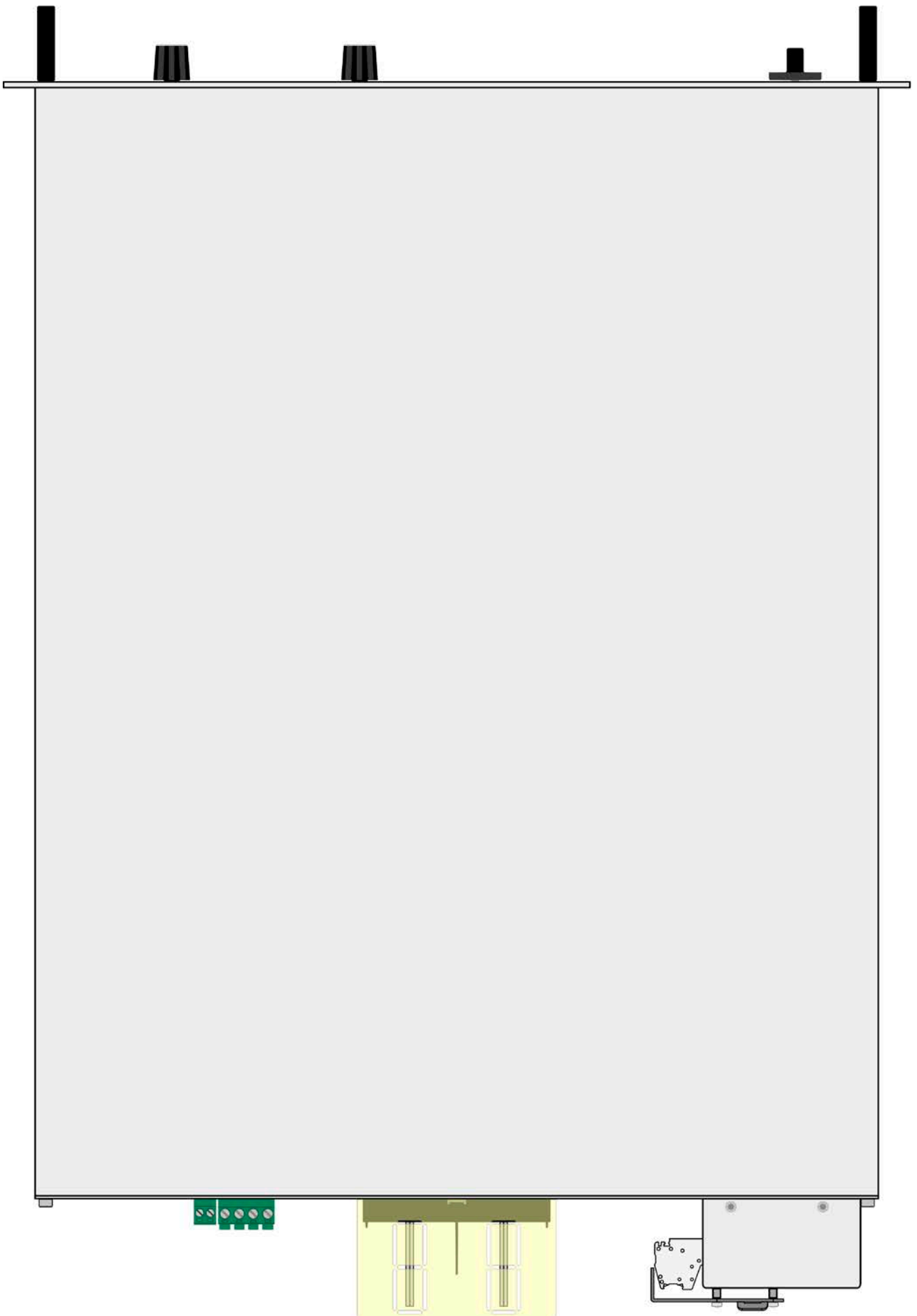

Figure 5 - Top view

1.8.6 Control elements

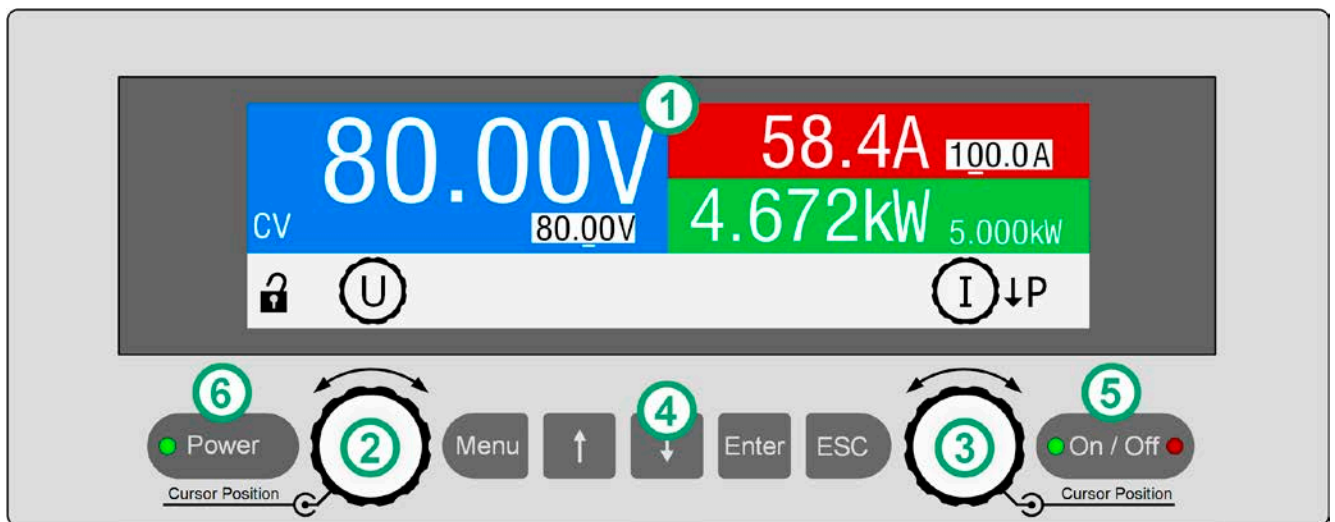







Figure 6- Control Panel

Overview of the elements of the operating panel

For a detailed description see section „1.9.6. The control panel (HMI)“.

(1)	Display Used for indication of set values, menus, conditions, actual values and status.
(2)	Left hand rotary knob, with button function Turn: adjusts various set values which are related to the DC output voltage. Push: selects the decimal position of a value to be changed (cursor)
(3)	Right hand rotary knob, with button function Turn: adjusts various set values which are related to the DC output current, the DC output power. Also adjusts parameters in the setup menu. Push: selects the decimal position of a value to be changed (cursor)
(4)	Button bank Button  : Activates the setup menu for various device settings (see „3.4.3. Configuration in the setup menu“) Button  : Navigates through menus, submenus and parameters (direction: up / left) Button  : Navigates through menus, submenus and parameters (direction: down / right) Button  : Submits altered parameters or set values in submenus, as well enters submenus. Can also be used to acknowledge alarms Button  : Cancels changes of parameters in the setup menu or leaves submenus
(5)	On/Off button for DC output  Used to toggle the DC output between on and off, also used to acknowledge alarms. The LEDs “On” and “Off” indicate the state of the DC output, no matter if the device is manually controlled or remotely.
(6)	LED “Power” Indicates different colors during the start of the device and once ready for operation, it turns green and remains for the period of operation.

1.9 Construction and function

1.9.1 General description

The electronic high performance power supplies of the PSE 9000 3U series are especially suitable for test systems and industrial controls due to their compact construction in a 19" enclosure with 3 height units (3U).

For remote control using a PC or PLC the devices are provided as standard with an USB-B slot on the back side as well as a galvanically isolated analog interface.

Via optional plug-in interface modules, other digital interfaces such as Ethernet, Profibus, ProfiNet, ModBus TCP, CANopen, CAN, RS232 or EtherCAT can be added. These enable the devices to be connected to standard industrial buses simply by changing or adding a small module. The configuration, if necessary at all, is simple.

In addition, the devices offer as standard the possibility for parallel connection in Share bus operation for constant current sharing plus a genuine master-slave connection with totaling of the slave units' values is also provided as standard. Operating in this way allows up to 16 units to be combined to a single system with a total power of up to 240 kW.

All models are controlled by microprocessors. These enable an exact and fast measurement and display of actual values.

1.9.2 Block diagram

The block diagram illustrates the main components inside the device and their relationships.

There are digital, microprocessor controlled components (KE, DR, HMI), which can be target of firmware updates.

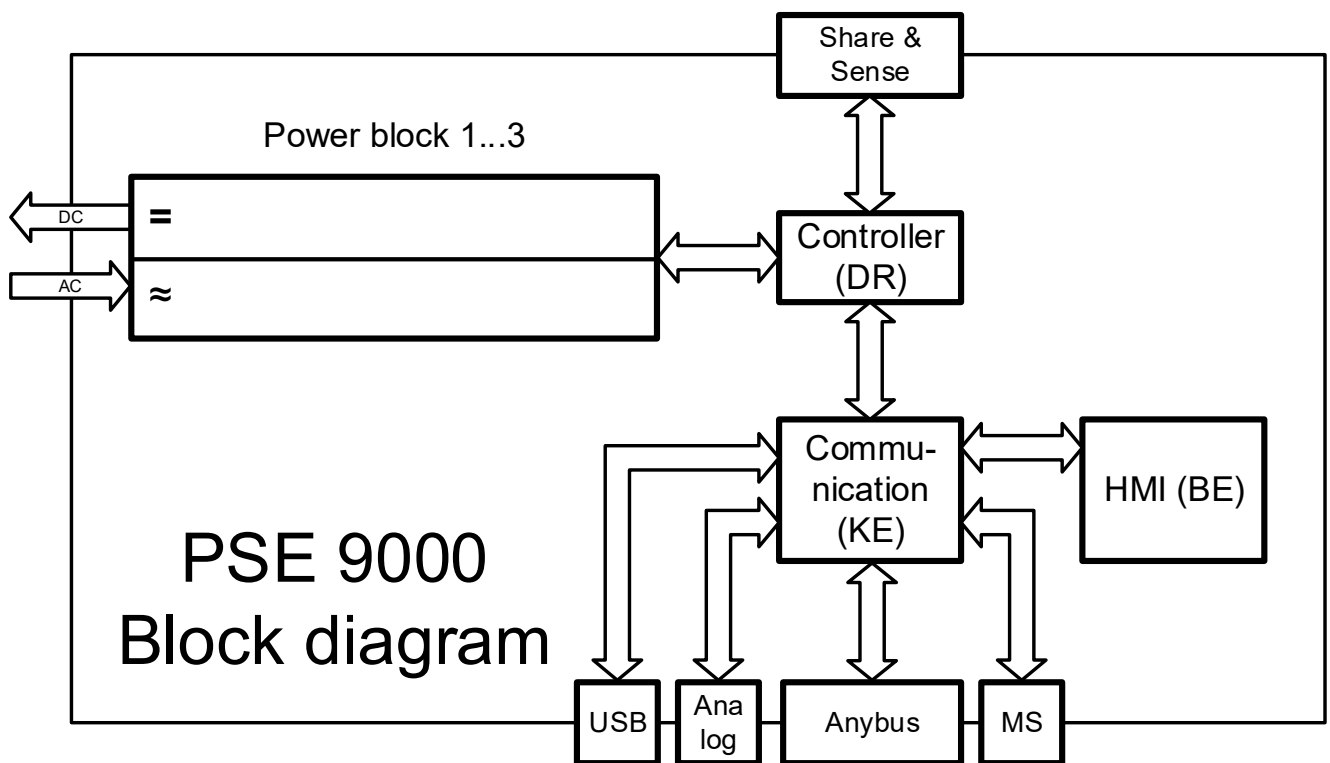

1.9.3 Scope of delivery

- 1 x Power supply device
- 1 x Share Bus plug
- 1 x Remote sensing plug
- 1 x 1.8 m (5.9 ft) USB cable
- 1 x Set of DC output covers
- 1 x Share/Sense terminal cover (only models from 750 V)
- 1 x USB stick with drivers, tools and documentation

1.9.4 Accessories

For these devices the following accessories are available:

POWER RACKS 19"-rack	Racks in various configurations up to 47U as parallel systems are available, or mixed with electronic load devices to create test systems. Further information in our product catalogue, on our website or upon request.
IF-AB Digital interface modules	Pluggable and retrofittable interface modules for RS232, CANopen, Ethernet, Profibus, ProfiNet, ModBus TCP, CAN or EtherCAT are available. Details about the interface modules and the programming of the device using those interfaces can be found in separate documentation. It's usually available on the USB stick, which is included with the device, or as PDF download on the manufacturers website.

1.9.5 Options

These options are usually ordered along with the order of a new unit, because they are permanently built-in during the manufacturing process. Possible retrofit upon request.

HS „High-Speed Ramping“	Increased output voltage dynamics by reduced filter capacity on the DC output. NOTE: other DC output related values, like the ripple, also increase. This is a permanent feature which can't be switched off.
-----------------------------------	--

1.9.6 The control panel (HMI)

The HMI (Human Machine Interface) consists of a color TFT display, two rotary knobs with button function and six pushbuttons.

1.9.6.1 Display

The display is divided into a number of areas. In normal operation the upper part is used to show actual values and the lower part is used to display status information and set values:

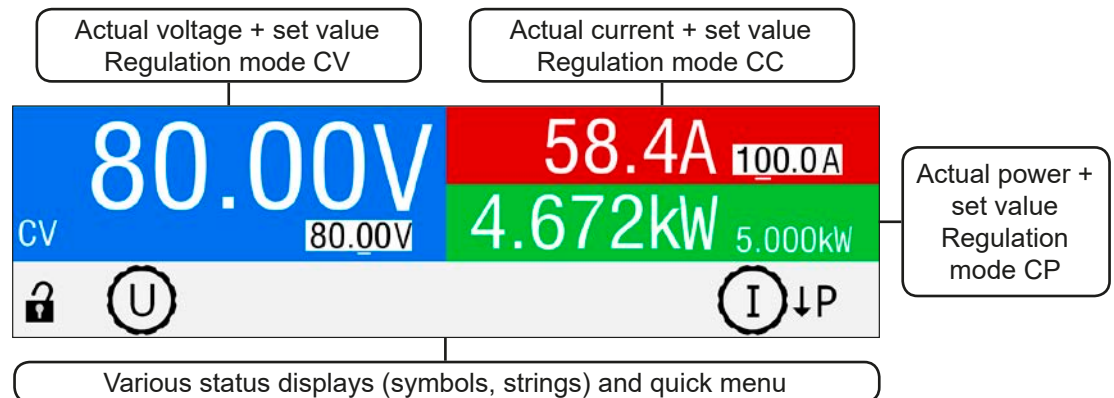

• Actual / set values area (blue / green / red)

In normal operation the DC output values (large numbers) and set values (small numbers) for voltage, current and power are displayed.

While the DC output is switched on, the actual regulation mode **CV**, **CC** or **CP** is displayed above to the corresponding set value, as shown in the figure above with example “CV”.

The set values can be adjusted by rotating the knobs below the display, whereas pushing the knobs are used to select the digit to be changed. Logically, the values are increased by clockwise turning and decreased by anti-clockwise turning. The current assignment of set a value to a knob is indicated by the corresponding set value being displayed in inverted form and also by the knob depiction in the status area showing the physical sign (U, I,P). In case these are not shown, the values can't be adjusted manually, like in HMI lock or remote control.

General display and settings ranges:

Display	Unit	Range	Description
Actual voltage	V	0-125% U_{Nom}	Actual values of DC output voltage
Set value voltage	V	0-102% U_{Nom}	Set value for limiting the DC output voltage
Actual current	A	0.2-125% I_{Nom}	Actual value of DC output current
Set value current	A	0-102% I_{Nom}	Set value for limiting the DC output current
Actual power	kW	0-125% P_{Nom}	Actual value of output power, $P = U * I$
Set value power	kW	0-102% P_{Nom}	Set value for limiting DC output power
Adjustment limits	A, V, W	0-102% of rated	U-max, I-min etc., related to the physical quantities
Protection settings	A, V, W	0-110% of rated	OVP, OCP etc., related to the physical quantities

• Status display (lower part)

This area displays various status texts:

Display	Description
Locked	The HMI is locked
Remote:	The device is under remote control from...
Analog	...the built-in analog interface
USB & others	...the built-in USB port or a plug in interface module
Local	The device has been locked by the user explicitly against remote control
Alarm: OT etc.	Alarm condition which has not been acknowledged or still exists
M	Master-slave mode activated, device is master
S x	Master-slave mode activated, device is slave with slave address x (1-15)

1.9.6.2 Rotary knobs



As long as the device is in manual operation, the two rotary knobs are used to adjust set values, as well as setting the parameters in the settings menu. For a detailed description of the individual functions see section „3.4 Manual operation“ on page 42. Both rotary knobs have an additional pushbutton function to select the decimal position of the value to be set. In this way the set current value for a device with, for example, nominal 510 A can be adjusted in increments of 10 A or 0.1 A (also see 1.9.6.4)

1.9.6.3 Button function of the rotary knobs

The rotary knobs also have a pushbutton function which is to used to move the cursor during value adjustment by rotation as shown:



1.9.6.4 Resolution of the displayed values

In the display, set values can be adjusted in fixed increments. The number of decimal places depends on the device model. The values have 4 or 5 digits. Actual and set values always have the same number of digits.

Adjustment resolution and number of digits of set values in the display:

Voltage, OVP, U-min, U-max			Current, OCP, I-min, I-max			Power, OPP, P-max		
Nominal	Digits	Minimum increment	Nominal*	Digits	Minimum increment	Nominal*	Digits	Minimum increment
40 V / 80 V	4	0.01 V	20 A	5	0.001 A	3.3 - 6.6 kW	4	0.001 kW
200 V	5	0.01 V	30 A - 90 A	4	0.01 A	10 kW / 15kW	4	0.01 kW
360 V / 500 V	4	0.1 V	≥120 A	4	0.1 A	MS ≥15 kW	4	0.01 kW
750 V	4	0.1 V	MS >1000 A	5	0.1 A	MS ≥100 kW	4	0.1 kW
1000 V	5	0.1 V	MS >3000 A	4	1 A			
1500 V	5	0.1 V						

*) MS = Master-slave

1.9.7 USB port

The USB port on the back side of the device is provided for communication with the device and for firmware updates. The included USB cable can be used to connect the device to a PC (USB 2.0, USB 3.0). The driver is delivered on the included USB stick or is available as download and installs a virtual COM port.

The device can be addressed via the USB port either using the international standard Mod-Bus RTU protocol or by SCPI language. The device recognizes the message protocol used automatically. Details for remote control can be found in external documentation, a general programming guide, on the web site of the manufacturer or on the included USB stick.

If remote control is in operation the USB port has no priority over either the analog interface or the other digital interface (slot) and can, therefore, only be used alternatively to these. However, monitoring is always available.

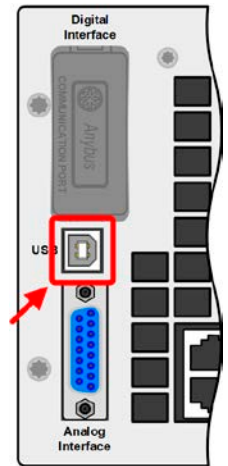

1.9.8 Interface module slot

This slot on the back side of the device is available for various modules of the IF-AB interface series. The following options are available:

Article number	Name	Description
35400100	IF-AB-CANO	CANopen, 1x Sub-D 9pole, male
35400101	IF-AB-RS232	RS 232, 1x Sub-D 9pole, male (null modem)
35400103	IF-AB-PBUS	Profibus DP-V1 Slave, 1x Sub-D 9pole female
35400104	IF-AB-ETH1P	Ethernet, 1x RJ45
35400105	IF-AB-PNET1P	ProfiNET IO, 1x RJ45
35400107	IF-AB-MBUS1P	ModBus TCP, 1x RJ45
35400108	IF-AB-ETH2P	Ethernet, 2x RJ45
35400109	IF-AB-MBUS2P	ModBus TCP, 2x RJ45
35400110	IF-AB-PNET2P	ProfiNET IO, 2x RJ45
35400111	IF-AB-CAN	CAN 2.0 A / 2.0 B, 1x Sub-D 9-pole, male
35400112	IF-AB-ECT	EtherCAT, 2x RJ45

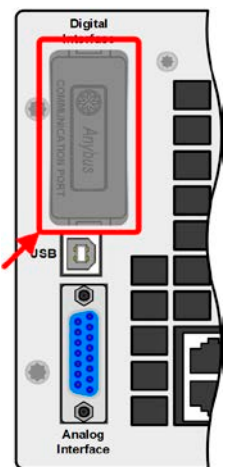

The modules are installed by the user and can be retrofitted without problem. A firmware update of the device may be necessary in order to recognize and support certain modules.

If remote control is in operation the interface module has no priority over either the USB port or the analog interface and can, therefore, only be used alternately to these. However, monitoring is always available.



Switch off device before adding or removing modules!

1.9.9 Analog interface

This 15 pole Sub-D socket on the back side of the device is provided for remote control of the device via analog signals or switching conditions.

If remote control is in operation this analog interface can only be used alternately to the digital interface. However, monitoring is always available.

The input voltage range of the set values and the output voltage range of the monitor values, as well as reference voltage level can be switched in the settings menu of the device between 0-5 V and 0-10 V, in each case for 0-100%.

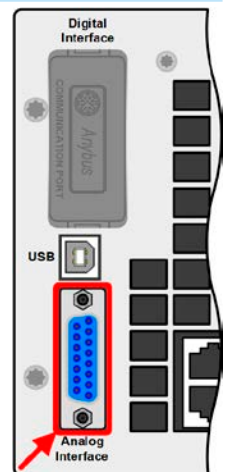

1.9.10 Share Bus connection

The 2 pole Phoenix socket ("Share") on the back side of the device is provided for connection to equally named sockets on compatible power supplies series to achieve a balanced load current distribution during parallel connection of up to 10 units. For more information skip to „3.9.1. Parallel operation in master-slave (MS)“. There is furthermore to option to create a two-quadrants operation system with compatible electronic loads. For this, refer to „3.9.4. Two quadrants operation (2QO)“.

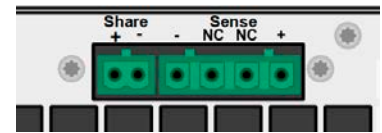

Following series are compatible with their Share Bus:

- PS 9000 1U / 2U / 3U (new series from 2014)
- PSE 9000 3U
- PSI 9000 2U/3U (new series from 2013)
- ELR 9000
- EL 9000 B

1.9.11 Sense connector (remote sensing)

If the output voltage has to be dependent on the consumer location rather than the DC output of the power supply, then the input "Sense" can be connected to the consumer where the DC connection is made. This compensates, up to a certain limit, the voltage difference between the power supply output and the consumer, which is caused by the high current through the load cables. The maximum possible compensation is given in the technical data.



In order to ensure safety and to comply to international directives, insulation of high voltage models, i. e. such with a nominal voltage of 500 V or higher, is ensured by using only the two outer pins of the 4-pole terminal. The inner two pins, marked with NC, must remain unconnected.

2. Installation and commissioning

2.1 Transport and storage

2.1.1 Transport



- The handles on the front side of the device are **not** for carrying!
- Because of its weight, transport by hand should be avoided where possible. If unavoidable then only the housing should be held and not on the exterior parts (handles, DC output terminal, rotary knobs).
- Do not transport when switched on or connected!
- When relocating the equipment use of the original packing is recommended
- The device should always be carried and mounted horizontally
- Use suitable safety clothing, especially safety shoes, when carrying the equipment, as due to its weight a fall can have serious consequences.

2.1.2 Packaging

It's recommended to keep the complete transport packaging for the lifetime of the device for relocation or return to the manufacturer for repair. Otherwise the packaging should be disposed of in an environmentally friendly way.

2.1.3 Storage

In case of long term storage of the equipment it's recommended to use the original packaging or similar. Storage must be in dry rooms, if possible in sealed packaging, to avoid corrosion, especially internal, through humidity.

2.2 Unpacking and visual check

After every transport, with or without packaging, or before commissioning, the equipment should be visually inspected for damage and completeness using the delivery note and/or parts list (see section „1.9.3. *Scope of delivery*“). An obviously damaged device (e.g. loose parts inside, damage outside) must under no circumstances be put in operation.

2.3 Installation

2.3.1 Safety procedures before installation and use



- The device may, according to model, have a considerable weight. Therefore the proposed location of the equipment (table, cabinet, shelf, 19" rack) must be able to support the weight without restriction.
- When using a 19" rack, rails suitable for the width of the housing and the weight of the device are to be used. (see „1.8.3. *Specific technical data (400 V models)*“)
- Before connecting to the mains ensure that the supply voltage is as shown on the product label. Overvoltage on the AC supply can cause equipment damage.

2.3.2 Preparation

Mains connection for the PSE 9000 3U series is done via the included 5 pole plug on the back of the device. Configuration of the plug is 3 wire (L2+L3+PE) or 4 wire (L1+L2+L3+PE), depending on the model, and with suitable cross section and length. Full configuration, i. e. 3 phases plus PE and also N (400 V models only) is acceptable.

For recommendations for cable cross section see „2.3.4. Connection to AC supply“.

Dimensioning of the DC wiring to the load/consumer has to reflect the following:



- The cable cross section should always be specified for at least the maximum current of the device.
- Continuous operation at the approved limit generates heat which must be removed, as well as voltage loss which depends on cable length and heating. To compensate for these the cable cross section should be increased and the cable length reduced.

2.3.3 Installing the device



- Select the location for the device so that the connection to the load is as short as possible.
- Leave sufficient space behind the equipment, minimum 30 cm (12”), for ventilation.

A device in a 19” housing will usually be mounted on suitable rails and installed in 19” racks or cabinets. The depth of the device and its weight must be taken into account. The handles on the front are for sliding in and out of the cabinet. Slots on the front plate are provided for fixing the device (fixing screws not included).

Acceptable and unacceptable installation positions:

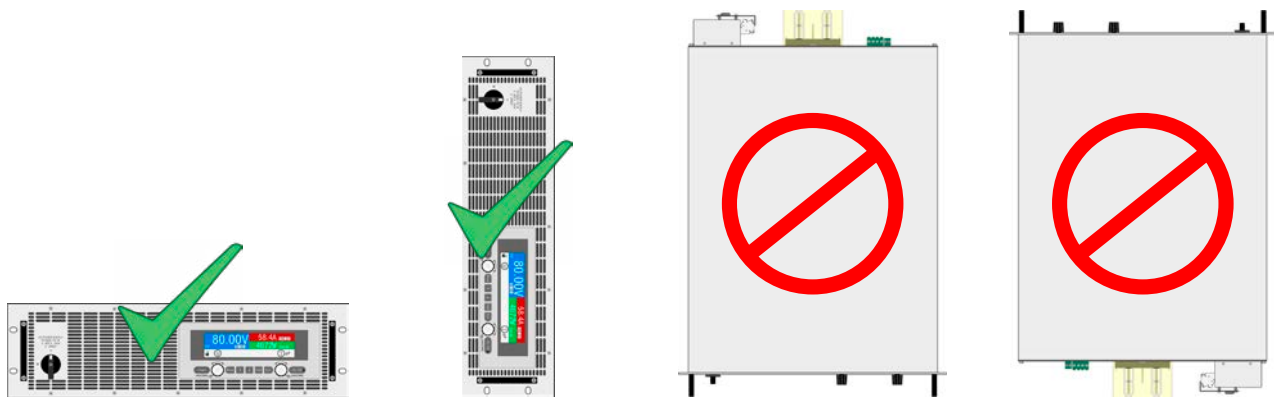

Standing surface

2.3.4 Connection to AC supply



- Connection to an AC mains supply may only be carried out by qualified personnel!
- Cable cross section must be suitable for the maximum input current of the device (see tables below)!
- Before plugging in the input plug ensure that the device is switched off by its mains switch!

2.3.4.1 Models for 400 V

The device is delivered with a 5 pole AC plug. Depending on model, the plug is connected to a 2-phase or 3-phase AC supply, according to the labeling on the plug. Required are following phases:

Nominal power	Inputs on AC plug	Supply type
3.3 kW / 5 kW	L2, L3, PE	Two- or three-phase
6.6 kW / 10 kW	L1, L2, L3, PE	Three-phase
≥15 kW	L1, L2, L3, PE	Three-phase



The PE conductor is imperative and must always be wired!

For the selection of a suitable cable **cross section** the rated AC current of the device and the cable length are decisive. Based on the connection of **one single unit** the table lists the maximum input current and recommended minimum cross section for each phase:

Nominal power	L1		L2		L3		PE
	∅	I _{max}	∅	I _{max}	∅	I _{max}	∅
3.3 kW	-	-	2.5 mm ²	11 A	2.5 mm ²	11 A	2.5 mm ²
5 kW	-	-	2.5 mm ²	16 A	2.5 mm ²	16 A	2.5 mm ²
6.6 kW	2.5 mm ²	19 A	2.5 mm ²	11 A	2.5 mm ²	11 A	2.5 mm ²
10 kW (except for 40 V models)	4 mm ²	28 A	4 mm ²	16 A	4 mm ²	16 A	4 mm ²
10 kW (40 V models)	2.5 mm ²	19 A	2.5 mm ²	19 A	2.5 mm ²	19 A	2.5 mm ²
15 kW	4 mm ²	28 A	4 mm ²	28 A	4 mm ²	28 A	4 mm ²

The included connection plug can receive crimped cable ends of up to 6 mm². The longer the connection cable, the higher the voltage loss due to the cable resistance. Therefore the mains cables should be kept as short as possible or use bigger cross section.

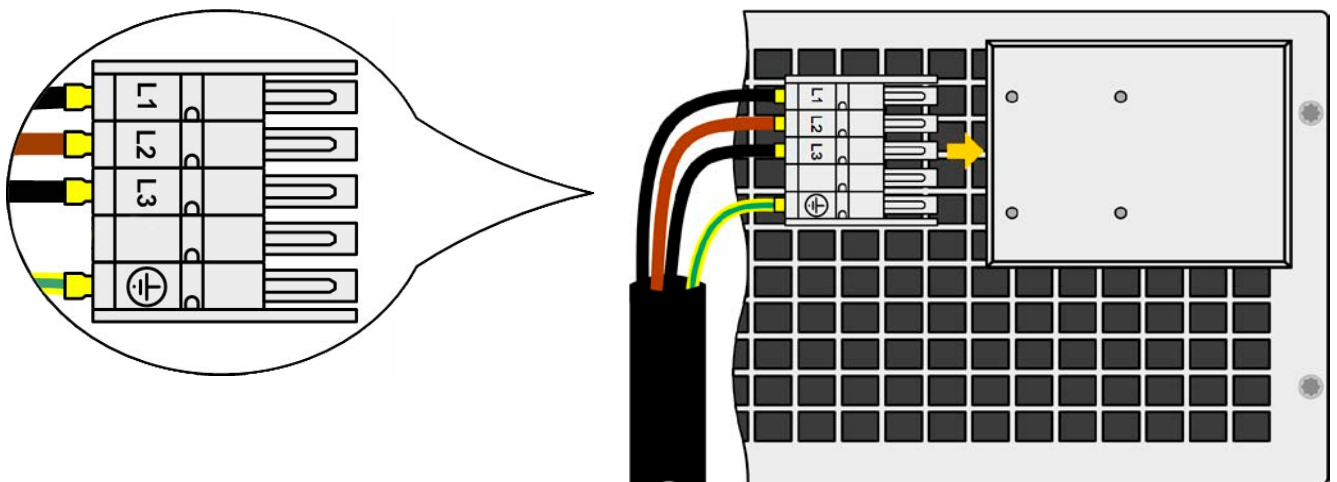

Figure 7 - Example for a supply cord (cable not included in delivery)

2.3.4.2 Models for 208 V

The 208 V models are delivered with a 4 pole mains plug for higher currents. Depending on model, the device requires a supply with 2 or 3 phases and 208 V three-phase, which have to be wired according to the labeling on the plug. Phase requirement:

Nominal power	Inputs on AC plug	Supply type
5 kW	L2, L3, PE	Three-phase
≥10 kW	L1, L2, L3, PE	Three-phase

For the wiring **cross section**, the power of the device and the cable length are decisive. The table below shows the maximum output current for each phase, based on the connection of a **standalone unit**:

Nominal power	L1		L2		L3	
	∅	I _{max}	∅	I _{max}	∅	I _{max}
5 kW	-	-	AWG 12	29 A	AWG 12	29 A
10 kW	AWG 8	51 A	AWG 8	29 A	AWG 8	29 A
15 kW	AWG 8	51 A	AWG 8	51 A	AWG 8	51 A

The included AC plug can receive loose or soldered cable ends of up to 16 mm² (AWG 6). The longer the connection cable, the higher the voltage loss due to the cable resistance. Therefore the mains cables should be kept as short as possible or use bigger cross section.

Connection schemes:

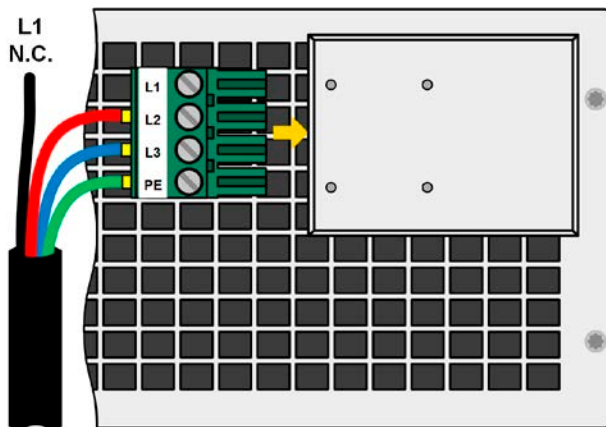

Figure 8 - L2+L3+PE connection scheme for 5 kW models

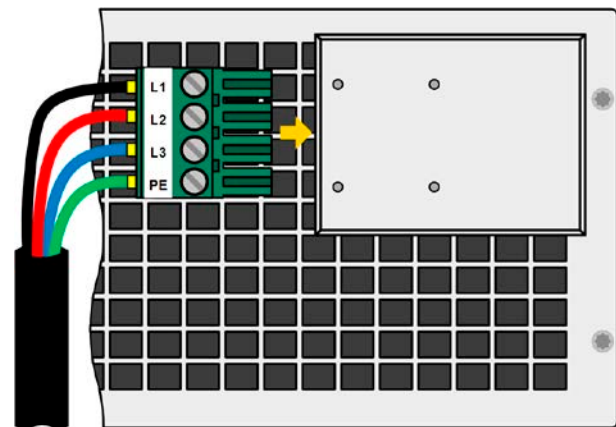

Figure 9 - Full connection scheme for 10 kW or higher models

2.3.4.3 Strain relief and plug fixture

There is a standard fixture mounted to the AC input connection block on the rear. It's used to prevent the AC plug from loosening and disconnecting due to vibrations or similar. The fixture is also used as strain relief.

Using the 4x M3 acorn nuts, it's recommend to mount the fixture to the AC filter block every time the AC plug has been plugged again.

It's furthermore recommended to install the strain relief by using suitable cable straps (not included), as depicted in the figure to the right.

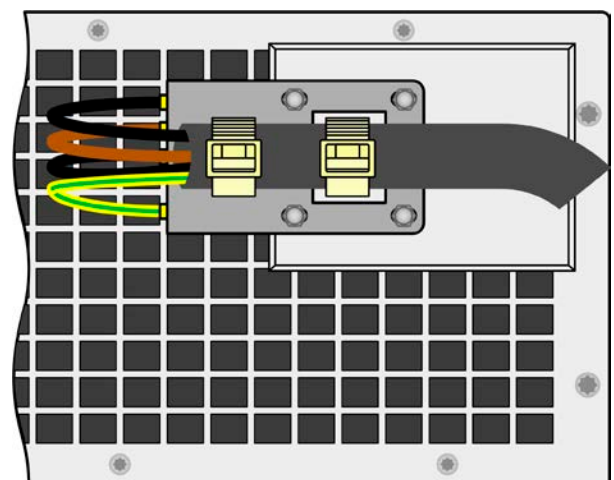

2.3.4.4 Connection variants

Depending on the max. output power of a specific model, it requires two or three phases of a three-phase AC supply. In case **multiple units with 3.3 kW to 10 kW power rating** are connected to the same AC supply point, it's recommended to take care for balanced current distribution on the three phases. See table in 2.3.4 for the max. phase currents.

The **15 kW** models are an exception, because they already consume balanced current on all three phases. As long as only such models are installed, no unbalanced AC load is expected. Systems of 15 kW models mixed with 10 kW models (note: the 10 kW model PSE 9040-510 3U is internally configured like a 15 kW) or models with lower power are not automatically balanced, but it can be achieved with a certain number of units which can be calculated.

Suggestions to assign phases:

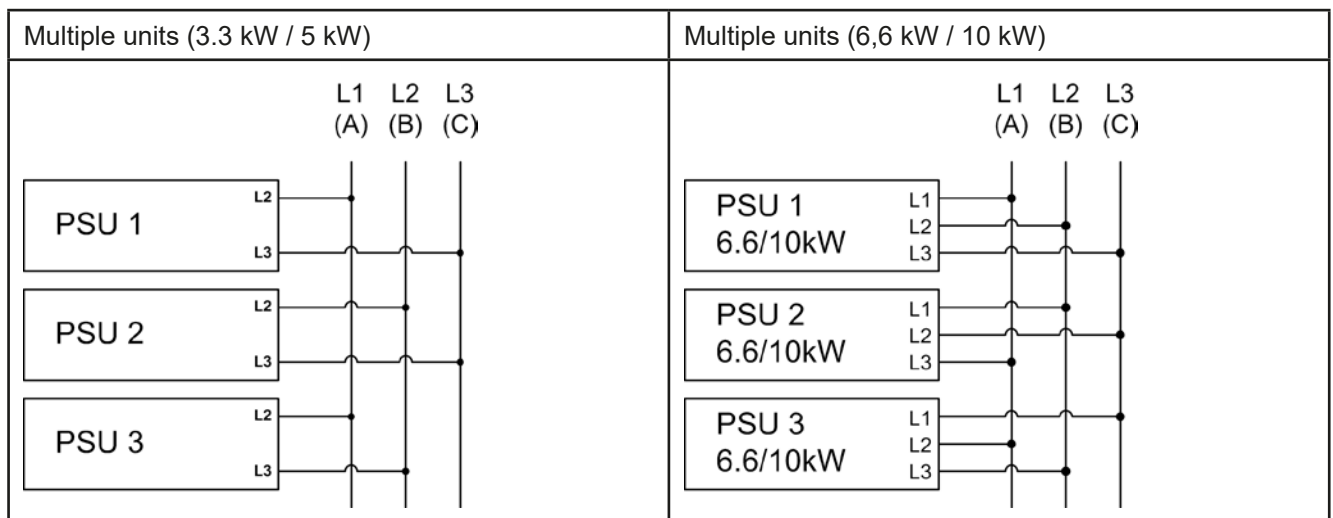
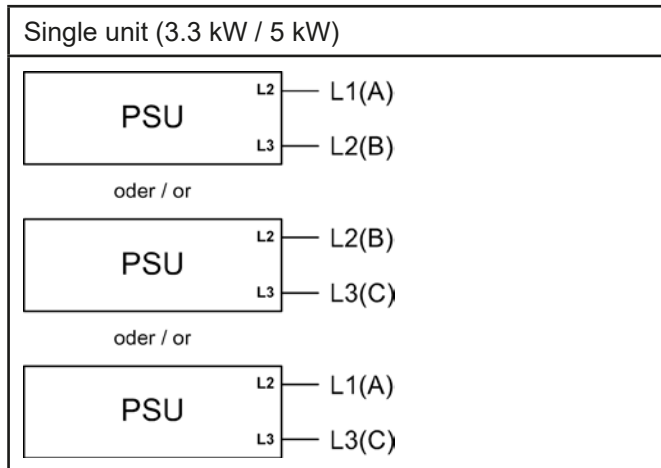

2.3.5 Connection to DC loads



- In the case of a device with a high nominal current and hence a thick and heavy DC connection cable it's necessary to take account of the weight of the cable and the strain imposed on the DC connection. Especially when mounted in a 19" cabinet or similar, where the cable hangs on the DC output, a strain reliever should be used.
- Connection to and operation with transformerless DC-AC inverters (for example solar inverters) is restricted, because the inverter can shift the potential of negative output (DC-) against PE (ground), which is generally limited to max. 400 V DC.

The DC load output is on the back side of the device and isn't protected by a fuse. The cross section of the connection cable is determined by the current consumption, cable length and ambient temperature.

For cables up to 5 m (16.4 ft) and average ambient temperature up to 50°C (122 °F), we recommend:

up to 30 A :	6 mm ²	up to 70 A :	16 mm ²
up to 90 A :	25 mm ²	up to 140 A :	50 mm ²
up to 170 A :	70 mm ²	up to 210 A :	95 mm ²
up to 340 A :	2x70 mm ²	up to 510 A :	2x120 mm ²

per connection pole (multi-conductor, insulated, openly suspended). Single cables of, for example, 70 mm² may be replaced by e.g. 2x35 mm² etc. If the cables are long then the cross section must be increased to avoid voltage loss and overheating.

2.3.5.1 DC terminal types

The table below shows an overview of the various DC terminals. It's recommended that connection of load cables always utilizes flexible cables with ring lugs.

Type 1: Models up to 360 V output voltage	Type 2: Models from 500 V output voltage
M8 bolt on a metal rail Recommendation: ring lug with a 8 mm hole	M6 bolt on a metal rail Recommendation: ring lug with a 6 mm hole

2.3.5.2 Cable lead and plastic cover

A plastic cover for contact protection is included for the DC terminal. It should always be installed. The cover for type 2 (see picture above) is fixed to the connector itself, for type 1 to the back of the device. Furthermore the cover for type 1 has break outs so that the supply cable can be laid in various directions.



The connection angle and the required bending radius for the DC cable must be taken into account when planning the depth of the complete device, especially when installing in a 19" cabinet or similar. For type 2 connectors only a horizontal lead can be used to allow for installation of the cover.

Examples of the type 1 terminal:

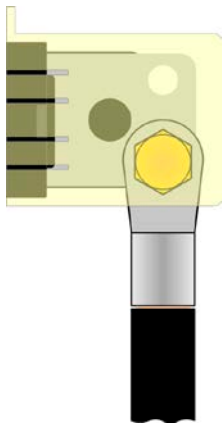

- 90° up or down
- space saving in depth
- no bending radius

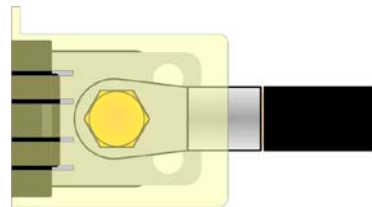

- horizontal lead
- space saving in height
- large bending radius

2.3.6 Connection of remote sensing

In order to compensate, to a certain degree, the voltage loss in a DC cable, the device provides the possibility to connect the remote sensing input "Sense" to the load. The device recognizes the remote sensing mode automatically and regulates the output voltage (only in CV operation) at the load rather than at its own DC output.

In the technical specifications (see section „1.8.3. Specific technical data (400 V models)“) the level of maximum possible compensation is given. If that is insufficient, the DC cable cross section must be increased.



Both pins „NC“ of the Sense connector must not be wired!



- Remote sensing is only effective during constant voltage operation (CV) and for other regulation modes the sense input should be disconnected, if possible, because connecting it generally increases the oscillation tendency.
- The cross section of the sense cables is noncritical. However, it should be increased with increasing cable length. Recommendation: for cables up to 5 m (16.4 ft) use at least 0.5 mm²
- Sense cables should be twisted and laid close to the DC cables to damp oscillation. If necessary, an additional capacitor should be installed at the load/consumer to eliminate oscillation
- The sense cables must be connected + to + and - to - at the load, otherwise both systems may be damaged
- In master-slave operation, the remote sensing should be connected to the master unit only

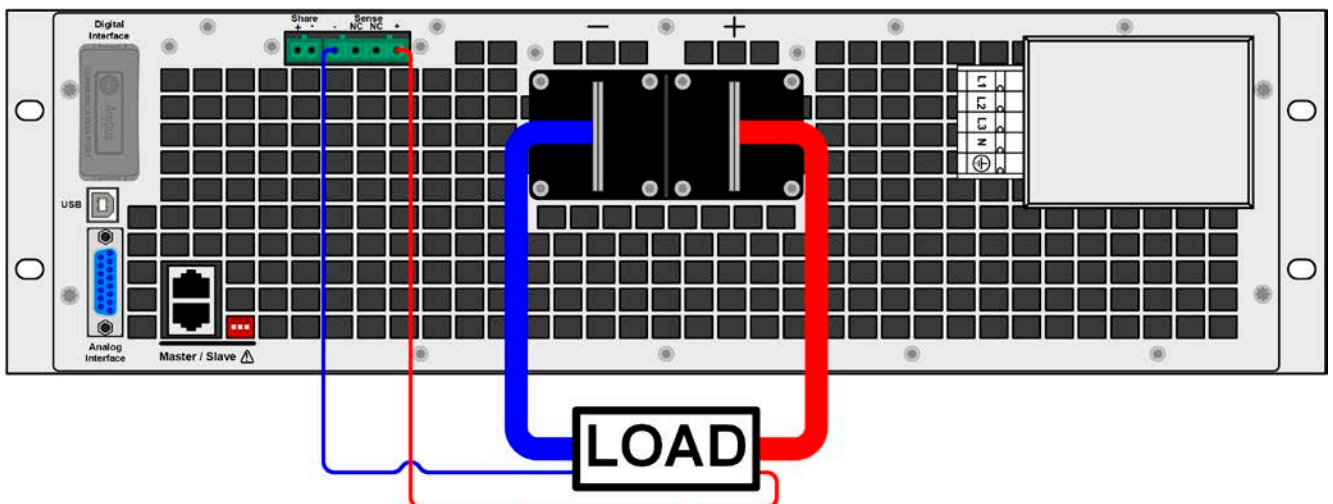

Figure 10 - Example for remote sensing wiring

2.3.7 Grounding of the DC output

Grounding one of the DC output poles is allowed. Doing so results in a potential shift of the other pole against PE. Because of insulation, there is a max. allowed potential shift of the DC output poles, which also depends on the device model. Refer to „1.8.3. *Specific technical data (400 V models)*“ for details.

2.3.8 Connecting the “Share” bus

The “Share” bus connector on the back side is intended to balance the current of multiple units in parallel operation by equalling the output voltage. Alternatively, it can be connected to a compatible electronic load, like from series ELR 9000, in order to run a two-quadrants operation. For further information about this mode of operation can be found in section „3.9.4. *Two quadrants operation (2QO)*“.

For the connection of the share bus the following must be paid attention to:



- Connection is only permitted between compatible devices (see „1.9.10. *Share Bus connection*“ for details) and between a max. of 16 units
- When not using one or several units of a system configured with Share bus, because less power is required for an application, it's recommended to disconnect the unit's from the Share bus, because even when not powered they can have a negative impact on the control signal on the bus due to their impedance. Disconnection can be done by simply unplugging them from the bus or using switches in the positive line.

2.3.9 Connecting the analog interface

The 15 pole connector (Type: Sub-D, D-Sub) on the rear side is an analog interface. To connect this to a controlling hardware (PC, electronic circuit), a standard plug is necessary (not included in the scope of delivery). It's generally advisable to switch the device completely off before connecting or disconnecting this connector, but at least the DC output.



The analog interface is galvanically isolated from the device internally. Therefore do not connect any ground of the analog interface (AGND) to the DC minus output as this will cancel the galvanic isolation.

2.3.10 Connecting the USB port

In order to remotely control the device via this port, connect the device with a PC using the included USB cable and switch the device on.

2.3.10.1 Driver installation (Windows)

On the initial connection with a PC the operating system will identify the device as new hardware and will try to install a driver. The required driver is for a Communications Device Class (CDC) device and is usually integrated in current operating systems such as Windows 7 or 10. But it's strongly recommended to use and install the included driver installer (on CD or USB stick) to gain maximum compatibility of the device to our softwares.

2.3.10.2 Driver installation (Linux, MacOS)

We can't provide drivers or installation instructions for these operating systems. Whether a suitable driver is available is best found out by searching the Internet.

2.3.10.3 Alternative drivers

In case the CDC drivers described above are not available on your system, or for some reason do not function correctly, commercial suppliers can help. Search the Internet for suppliers using the keywords “cdc driver windows“ or “cdc driver linux“ or “cdc driver macos“.

2.3.11 Installation of an interface module

The optionally obtainable interface modules can be retrofitted by the user and are exchangeable with each other. The settings for the currently installed module vary and need to be checked and, if necessary, corrected on initial installation and after module exchange.



- Common ESD protection procedures apply when inserting or exchanging a module.
- The device must be switched off before insertion or removal of a module
- Never insert any other hardware other than a suitable interface module into the slot
- If no module is in use it's recommended that the slot cover is mounted in order to avoid internal dirtying of the device and changes in the air flow.

Installation steps:

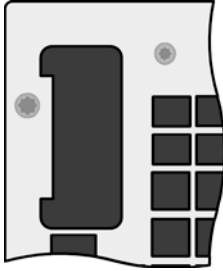
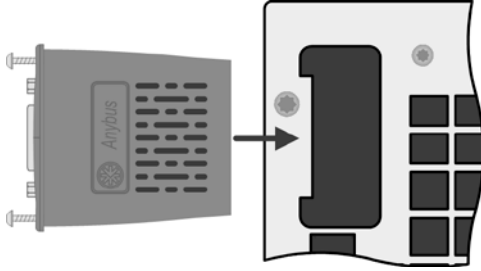
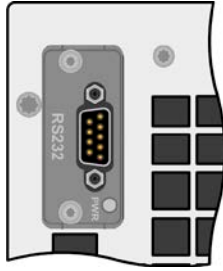
<p>1.</p> 	<p>2.</p> 	<p>3.</p> 
<p>Remove the slot cover. If needed use a screw driver.</p> <p>Check that the fixing screws of an already installed module are fully retracted. If not, unscrew them (Torx 8) and remove module.</p>	<p>Insert the interface module into the slot. The shape ensures correct alignment.</p> <p>When inserting take care that it's held as close as possible to a 90° angle to the rear wall of the device. Use the green PCB, which you can recognize on the open slot, as guide. At the end is a socket for the module.</p> <p>On the bottom side of the module are two plastic nibs which must click into the green PCB so that the module is properly aligned on the rear wall of the device.</p>	<p>The screws (Torx 8) are provided for fixing the module and should be fully screwed in. After installation, the module is ready for use and can be connected.</p> <p>Removal follows the reverse procedure. The screws can be used to assist in pulling out the module.</p>

2.3.12 Initial commission

For the first start-up after purchasing and installing the device, the following procedures have to be executed:

- Confirm that the connection cables to be used are of a satisfactory cross section
- Check that the default settings for set values, safety and monitoring functions and communication are suitable for your application and change them where necessary, as described in the manual
- In case of remote control via PC, read the additional documentation for interfaces and software
- In case of remote control via the analog interface, read the section in this manual concerning analog interfaces and, where needed, other appropriate documentation especially concerning the use of such interfaces

2.3.13 Initial network setup

The device is delivered with default network parameters (see „3.4.3.6. Menu “Communication”“). The optionally available Ethernet/LAN port is ready for use shortly after powering the device.

For wiring, i.e. the hardware connection to a network, contact and ask your IT manager or any similar responsible person. Network cable of common type (CAT5 or better) can be used.

In order to set up the network parameter to your needs, you have two options: the setup menu or the device's website. For the configuration in the setup menu please refer to „3.4.3.6. Menu “Communication”“.

For the configuration via the device's website, you need the device to be connected to a network or directly to a PC which can access the default IP 192.168.0.2.

► How to do the network setup on the device website

1. In case the device display is in any kind of menu, have menu to main display.
2. Open the device website in a browser by entering the default IP (<http://192.168.0.2>) or the default host name (<http://Client>, only possible if there is a running DNS in the network) into the URL box.
3. After the website has been completely loaded, check the status field item “**Access**” to show the status “**free**”. In case it shows different, the device is either already in remote control (**rem**) or blocked from remote control (**local**). If it shows “**local**”, first remove the block. Refer to section „3.5.2. Control locations“ to do that.
4. If it says “**rem**” in the “**Access**” item, skip to step 5. Else enter command **sys:lock on** (attention! space before **on**) into the **SCPI command** box and send with return key. Check if item “**Access**” in status field changes to “**rem-eth**” (means: remote Ethernet).
5. Switch to page **CONFIGURATION** (upper left corner) and set up the network parameters as well as the port here resp. activate DHCP and submit the change with **SUBMIT** button.
6. Wait a few seconds before testing the new IP by entering it in the browser's URL box. Opening the website again by using the host name is only possible after the device has restarted, because only then the new IP is reported to the DNS.

2.3.14 Commission after a firmware update or a long period of non-use

In case of a firmware update, return of the equipment following repair or a location or configuration change, similar measures should be taken to those of initial start up. Refer to „2.3.12. Initial commission“.

Only after successful checking of the device as listed may it be operated as usual.

3. Operation and application

3.1 Important notes

3.1.1 Personal safety



- In order to guarantee safety when using the device, it's essential that only persons operate the device who are fully acquainted and trained in the required safety measures to be taken when working with dangerous electrical voltages
- For models which can generate a voltage which is dangerous by contact, or is connected to such, the included DC terminal cover, or an equivalent, must always be used
- Whenever the load and DC output are being re-configured, the device should be disconnected from the mains, not only the DC output switched off!

3.1.2 General



- Unloaded operation isn't considered as a normal operation mode and can thus lead to false measurements, for example when calibrating the device
- The optimal working point of the device is between 50% and 100% voltage and current
- It's recommended to not run the device below 10% voltage and current, in order to make sure technical values like ripple and transient times can be met

3.2 Operating modes

A power supply is internally controlled by different control or regulation circuits, which shall bring voltage, current and power to the adjusted values and hold them constant, if possible. These circuits follow typical laws of control systems engineering, resulting in different operating modes. Every operating mode has its own characteristics which is explained below in short form.

3.2.1 Voltage regulation / constant voltage

Voltage regulation is also called constant voltage operation (CV).

The DC output voltage of a power supply is held constant on the adjusted value, unless the output current or the output power according to $P = U_{OUT} \cdot I_{OUT}$ reaches the adjusted current or power limit. In both cases the device will automatically change to constant current or constant power operation, whatever occurs first. Then the output voltage can not be held constant anymore and will sink to a value resulting from Ohm's law.

While the DC output is switched on and constant voltage mode is active, then the condition "CV mode active" will be indicated on the display by the abbreviation **CV** and this message will be passed as a signal to the analog interface, as well stored as status which can also be read as a status message via digital interface.

3.2.1.1 Transient time after load step

For constant voltage mode (CV), the technical date "Transient time after load step" (see 1.8.3) defines a time that is required by the internal voltage regulator of the device to settle the output voltage after a load step. Negative load steps, i.e. high load to lower load, will cause the output voltage to overshoot for a short time until compensated by the voltage regulator. The same occurs with a positive load step, i.e. low load to high load. There the output collapses for a moment. The amplitude of the overshoot resp. collapse depends on the device model, the currently adjusted output voltage and the capacity on the DC output and can thus not be stated with a specific value.

Depictions:

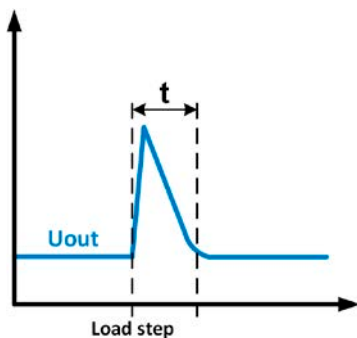

Example for a negative load step: the DC output will rise above the adjusted value for a short time. t = transient time to settle the output voltage.

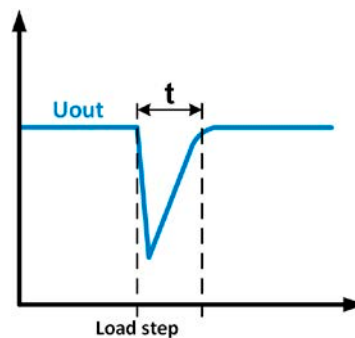

Example for a positive load step: the DC output will collapse below the adjusted value for a short time. t = transient time to settle the output voltage.

3.2.2 Current regulation / constant current / current limiting

Current regulation is also known as current limitation or constant current mode (CC).

The DC output current is held constant by the power supply, once the output current to the load reaches the adjusted limit. Then the power supply automatically switches to CC. The current flowing from the power supply is determined by the output voltage and the load's true resistance. As long as the output current is lower than the adjusted current limit, the device will be either in constant voltage or constant power mode. If, however, the power consumption reaches the set maximum power value, the device will automatically switch to power limiting and sets the output current according to $I_{MAX} = P_{SET} / U_{IN}$, even if the maximum current value is higher. The current set value, as determined by the user, is always an upper limit only.

While the DC output is switched on and constant current mode is active, then the condition "CC mode active" will be indicated on the display by the abbreviation **CC** and this message will be passed as a signal to the analog interface, as well stored as status which can also be read as a status message via digital interface.

3.2.3 Power regulation / constant power / power limiting

Power regulation, also known as power limiting or constant power (CP), keeps the DC output power of a power supply constant if the current flowing to the load in relation to the output voltage and the resistance of load reaches the adjusted value according to $P = U \cdot I$ resp. $P = U^2 / R$. The power limiting then regulates the output current according to $I = \sqrt{P / R}$, where R is the load's resistance.

Power limiting operates according to the auto-range principle such that at lower output voltages higher current flows and vice versa in order to maintain constant power within the range P_N (see diagram to the right)

Constant power operation primarily impacts the output current. This means, the adjusted maximum output current can not be achieved if the maximum power value limits the output current according to $I = P / U$. The adjustable set value of current, as indicated in the display, is always only an upper limit.

While the DC output is switched on and constant power mode is active, then the condition "CP mode active" will be shown on the display by the abbreviation **CP**, as well stored as status which can also be read as a status message via digital interface.

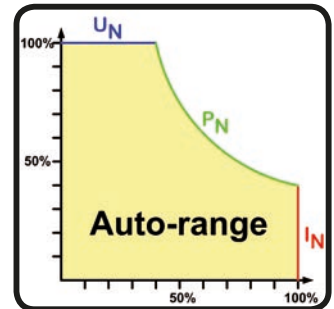

In remote sensing operation, i. e. when the Sense input is connected to the load, the increased voltage output and thus also increased power output isn't included in the actual power value, because the device then measures and regulates the voltage on the Sense input.

3.3 Alarm conditions



This section only gives an overview about device alarms. What to do in case your device indicates an alarm condition is described in section „3.6. Alarms and monitoring“.

As a basic principle, all alarm conditions are signaled optically (Text + message in the display), acoustically (if activated) and as a readable status via the digital interface. With any alarm occurring, the DC output of the device is switched off. In addition, the alarms OT and OVP are reported as signals on the analogue interface.

3.3.1 Power Fail

Power Fail (PF) indicates an alarm condition which may have various causes:

- AC input voltage too low (mains undervoltage, mains failure)
- Defect in the input circuit (PFC)
- Not all required AC input phases are connected (see „2.3.4. Connection to AC supply“ for requirements)



Switching off the device by the mains switch can not be distinguished from a mains blackout and thus the device will signalize a PF alarm every time the device is switched off. This can be ignored.

3.3.2 Overtemperature

An overtemperature alarm (OT) can occur if an excess temperature inside the device causes to switch off the DC output. This alarm condition is shown as the message “Alarm: OT” in the display. In addition, the condition will be passed as a signal to the analog interface, as well as alarm status and counter which both can be read via digital interface. After cooling down, the device can automatically switch the power stage back on, depending on the setting of parameter “DC output after OT alarm”. See section 3.4.3.1.

3.3.3 Overvoltage

An overvoltage alarm (OVP) will switch off the DC output and can occur if:

- the power supply itself, as a voltage source, generates an output voltage higher than set for the overvoltage alarm limit (OVP, 0...110% U_{Nom}) or the connected load somehow returns voltage higher than set for the overvoltage alarm limit
- the OV threshold has been adjusted too close above the output voltage. If the device is in CC mode and if it then experiences a negative load step, it will make the voltage rise quickly, resulting in a voltage overshoot for a short moment which can already trigger the OVP

This function serves to warn the user of the power supply acoustically or optically that the device probably has generated an excessive voltage which could damage the connected load application.



The device isn't fitted with protection from external overvoltage.

3.3.4 Overcurrent

An overcurrent alarm (OCP) will switch off the DC output and can occur if:

- The output current in the DC output reaches the adjusted OCP limit.

This function serves to protect the connected load application so that this isn't overloaded and possibly damaged due to an excessive current.

3.3.5 Overpower

An overpower alarm (OPP) will switch off the DC output and can occur if:

- the product of the output voltage and output current in the DC output reaches the adjusted OPP limit.

This function serves to protect the connected load application so that this isn't overloaded and possibly damaged due to an excessive power consumption.

3.4 Manual operation

3.4.1 Switching the device on

The device should, as far as possible, always be switched on using the rotary switch on the front of the device. Alternatively this can take place using an external cutout (contactor, circuit breaker) of suitable current capacity.

After switching on, the display will show the manufacturers logo, some device related information, a language selection and will then be ready for use. In setup (see section „3.4.3. Configuration in the setup menu“), in the second level menu **“General settings”** is an option **“DC output after power ON”** which allows the user can determine the condition of the DC output after power-up. Factory setting here is **“OFF”**, meaning that the DC output would always be switched off after start. Selection **“Restore”** would restore the condition of the DC output from last shutdown, means either on or off. All last set values are also restored.



For the time of the start phase the analog interface can signal undefined statuses on the output pins such as OT or OVP. Those signals must be ignored until the device has finished booting and is ready to work.

3.4.2 Switching the device off

On switch-off the last output condition and the most recent set values are saved. Furthermore, a PF alarm (power failure) will be reported, but can be ignored.

The DC output is immediately switched off and after a short while fans will shut down and after another few seconds the device will be completely powered off.

3.4.3 Configuration in the setup menu

The setup menu serves to configure all operating parameters which are not constantly required. It can be entered by pushing **Menu**, but only while the DC output is switched off. Also see the figures below.

While the DC output is switched on, pushing button **Menu** will only access the so-called quick menu.

Menu navigation is done with the pushbuttons ,  and **Enter**. Parameters (values, settings) are set using the rotary knobs.

The assignments of the rotary knobs, if multiple values can be set in a particular menu, is always the same: parameters on the left-hand side -> left-hand knob, parameters on the right-hand side -> right-hand knob

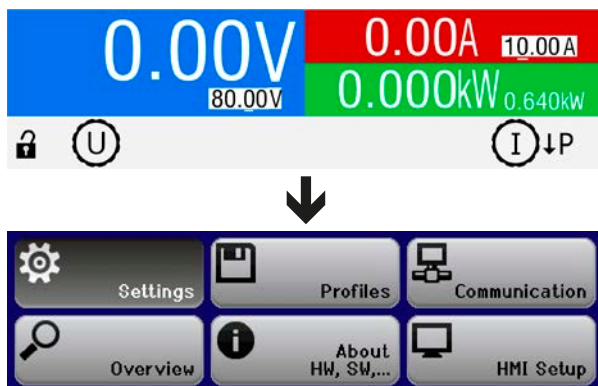

Some setting parameters are self-explanatory, others are not. The latter will be explained on the pages following.

3.4.3.1 Menu "General Settings"

Element	Description
Allow remote control	Selection "NO" means that the device can't be remotely controlled over any of the digital or analog interfaces. If remote control isn't allowed, the status will be shown as "Local" in the status area on the main display. Also see section 1.9.6.1
Analog interface range	Selects the voltage range for the analog inputs, actual value outputs and the reference voltage output of the analog interface on the rear. <ul style="list-style-type: none"> • 0...5 V = Range is 0...100% set /actual values, reference voltage 5 V • 0...10 V = Range is 0...100% set /actual values, reference voltage 10 V See also section „3.4.6. Switching the main screen view“
Analog interface Rem-SB	Determines with "Normal" (default), that the function and levels of input Rem-SB are as described in „3.5.4.4. Analog interface specification“. With selection "Inverted", the described function is logically inverted. Also see example a) in „3.5.4.7. Application examples“.
Analog interface pin 6	Pin 6 of the analog interface (see section 3.5.4.4) is by default assigned to only signal the device alarms OT and PF. This parameter allows to also enable signaling only one of both (3 possible combinations): <p>Alarm OT = Enable/disable signaling of alarm OT on pin 6</p> <p>Alarm PF = Enable/disable signaling of alarm PF on pin 6</p>
Analog interface pin 14	Pin 14 of the analog interface (see section 3.5.4.4) is by default assigned to only signal the device alarm OVP. This parameter allows to also enable signaling further device alarms (7 possible combinations): <p>Alarm OVP = Enable/disable signaling of alarm OVP on pin 14</p> <p>Alarm OCP = Enable/disable signaling of alarm OCP on pin 14</p> <p>Alarm OPP = Enable/disable signaling of alarm OPP on pin 14</p>
Analog interface pin 15	Pin 15 of the analog interface (see section 3.5.4.4) is by default assigned to only signal the regulation mode CV. This parameter allows to enable signaling a different device status (2 options): <p>Regulation mode = Enable/disable signaling of CV reg mode on pin 15</p> <p>DC status = Enable/disable signaling of DC terminal status on pin 15</p>
Analog Rem-SB action	Input REM-SB of the analog interface can be used to control the DC output of the device even without remote control via analog interface being activated. This setting determines the type of action: <ul style="list-style-type: none"> • DC OFF = Toggling the pin only switches the DC output off • DC ON/OFF = If the DC output has been switched on before, toggling the pin can switch the output off and on again
DC output after power ON	Determines the condition of the DC output after power-up. <ul style="list-style-type: none"> • OFF = DC output is always off after switching on the device. • Restore = DC output condition will be restored to the condition prior to switch off.
DC output after PF alarm	Determines the condition of the DC output after a power fail alarm (see 3.3.1). <ul style="list-style-type: none"> • OFF = DC output is always off after a PF alarm. • AUTO = DC output condition will be set to the condition prior to PF alarm.
DC output after OT alarm	Determines how the DC power stages shall react after an overtemperature (OT) alarm has occurred and the power stages have cooled down again: <ul style="list-style-type: none"> • OFF = DC power stage(s) will be off • AUTO = The device will automatically restore the situation before the OT alarm, which usually means the DC power stage(s) to be on
DC output after remote	Determines the condition of the DC output after leaving remote control either manually or by command. <ul style="list-style-type: none"> • OFF = DC output will be always off when switching from remote to manual • AUTO = DC output will keep the last condition
Master-slave mode	Selecting "Master" or "Slave" enables the master-slave mode (MS) and sets the selected position for the unit in the MS system. Default setting: OFF . For details see section „3.9.1. Parallel operation in master-slave (MS)“.

3.4.3.2 Menu “Calibrate Device”



This menu item is only available while master-slave mode is deactivated (setting “OFF”).

From within this menu, a calibration and readjustment procedure for output voltage and current can be started. For further details refer to „4.3. Calibration (readjustment)“.

Element	Description
Voltage calibration	Starts the semi-automatic calibration procedure for output voltage U
Sense volt. calibration	Starts the semi-automatic calibration procedure for remote sensing input „Sense“
Current calibration	Starts the semi-automatic calibration procedure for output current I
Set calibration date	Here you can enter the date of the most recent calibration (year, month, day)
Save and exit	This menu item saves and leaves the setup menu to main display

3.4.3.3 Menu “Reset Device”

Entering this menu item will prompt for acknowledgment to reset the device completely to default settings and set values. Selection “No” will cancel the reset procedure, while selection “Yes”, submitted by  button, will instantly reset the device.

3.4.3.4 Menu “Profiles”

See „3.8 Loading and saving a user profile“ on page 57.

3.4.3.5 Menus “Overview” and “About HW, SW...”

This menu page displays an overview of the set values (U, I, P) and related protection settings (OVP, OCP, OPP) as well as limits settings and an alarm history (counter) of alarms that might have occurred since the last time the unit was switched on. They furthermore show an overview of device relevant data such as serial number, article number etc.

3.4.3.6 Menu “Communication”

This submenu accesses settings for the digital communication via the optionally obtainable interface modules (IF-AB series), as well as the built in USB interface.

There is furthermore an adjustable communication timeout for USB and Ethernet. With USB or RS 232, it's used to make it possible to successfully transfer possibly fragmented messages (data packets) by setting higher timeout values. Refer to the external document “Programming ModBus & SCPI” for more information about fragmented messages.

In the screen “Communication Protocols” you can enable both or disable one of the two supported communication protocols, ModBus and SCPI. This can help to avoid mixing both protocols and to receive unreadable messages, for example when expecting a SCPI response and receiving a ModBus response instead.



For all Ethernet interfaces with two ports: „P1“ is related to port 1 and „P2“ to port 2, like printed on the module face. Two-port interfaces will use one IP only.

Submenus for interface modules, depending on the installed module:

IF	Menu item	Parameter	Description
CANopen	Node address	Node address	Selection of the CANopen node address in the range 1...127
	Baud rate	Baud rate	Manual selection of the baud rate that is used by the CANopen interface. Possible selections:
			Fixed baud rates: 10 kbps, 20 kbps, 50 kbps, 100 kbps, 125 kbps, 250 kbps, 500 kbps, 800 kbps, 1Mbps (1Mbps = 1Mbit/s, 10 kbps = 10 kbit/s)
			Auto : the baud rate is negotiated between the bus member, but usually given from a host (here: PC), which has to support this function, else auto setting will fail
			LSS (layer setting service): by selecting this settings, the interface expects to be assigned a node address and the baud rate from a bus master (here: PC), which has to support this function, else LSS setting will fail

IF	Menu item	Parameter	Description
CAN	ID Settings	Base ID	Setup of the CAN base ID (11 Bit or 29 Bit, hex format). Default: 0h
		Broadcast ID	Setup of the CAN broadcast ID (11 Bit or 29 Bit, hex format). Default: 7ffh
		Base ID cyclic read	Setup of the CAN base ID (11 Bit or 29 Bit, hex format) for cyclic read of up to 5 object groups (see " Cyclic Read Timing "). The device will automatically send specific object data to the IDs defined with this setting. For more information refer to the programming guide. Default: 100h
		Base ID cyclic send	Setup of the CAN base ID (11 Bit or 29 Bit, hex format) for cyclic send of status and set values in a more compact format. For more information refer to the programming guide. Default: 200h
	CAN Settings	Baud rate	Setup of the CAN bus speed or baud rate in typical value between 10 kbps and 1Mbps. Default: 500 kbps
		ID format	Selection of the CAN ID format between Base (11 Bit ID, 0h...7ffh) and Extended (29 Bit, 0h...1fffffffh)
		Termination	Activates or deactivates CAN bus termination with a built-in resistor. Default: OFF
		Data length	Determines the DLC (data length) of all messages sent from the device. AUTO = length varies between 3 and 8 bytes, depending on object Always 8 Bytes = length is always 8, filled up with zeros
	Cyclic Read Timing	Status	Activation/deactivation and time setting for the cyclic read of status to the adjusted „ Base ID cyclic read “. Range: 20...5000 ms. Default: 0 (deactivated)
		Actual values	Activation/deactivation and time setting for the cyclic read of actual values to the adjusted „ Base ID cyclic read + 1 “ Range: 20...5000 ms. Default: 0 (deactivated)
		Set values	Activation/deactivation and time setting for the cyclic read of set values to the adjusted „ Base ID cyclic read + 2 “ Range: 20...5000 ms. Default: 0 (deactivated)
		Limits 1	Activation/deactivation and time setting for the cyclic read of adjustment limits of U & I to the adjusted „ Base ID cyclic read + 3 “ Range: 20...5000 ms. Default: 0 (deactivated)
		Limits 2	Activation/deactivation and time setting for the cyclic read of adjustment limits of P & R to the adjusted „ Base ID cyclic read + 4 “ Range: 20...5000 ms. Default: 0 (deactivated)

IF	Menu item	Parameter	Description
Profibus DP	Node Address	Node address	Adjustment of the Profibus address (range 1...125)

IF	Menu item	Parameter	Description
RS232	Baud Rate	Bits per second	The baud rate is adjustable, other serial are fixed: 8 data bits, 1 stop bit, parity = none Baud rate settings: 2400, 4800, 9600, 19200, 38400, 57600, 115200

IF	Menu item	Parameter	Description
Ethernet / ModBus-TCP, 1 & 2 Port	IP Settings 1	Get IP address	Manual: this is the default option. Determines to set IP, subnet mask and gateway manually on the HMI or via remote control.
			DHCP: the interface will expect to get the three network addresses assigned from a DHCP server. In case there is no DHCP server in the network, the device will use the network addresses as defined for „Manual“.
		IP address	Define the network addresses in typical format here:
		Subnet mask	000.000.000.000 - 255.255.255.255
		Gateway	
	IP Settings 2	Port	Range: 0...65535. Default port: 5025
		DNS 1 address	Define domain name server addresses in the typical format here: 000.000.000.000 - 255.255.255.255
		DNS 2 address	
	Enable TCP keep-alive	Enables/disables network functionality “keep-alive” for the socket. Default setting: no	
	IP Settings 3	Eth. port 1	Manual selection for transmission speed (10MBit/100MBit) and duplex mode (full/half). It’s recommended to use the “AUTO” option and only revert to “Manual” if these parameters fail. Different Ethernet port settings for 2-port modules are possible, as these include an Ethernet switch
Eth. port 2			

Submenu “Communication Timeout”

Element	Description
Timeout USB (ms)	Default value: 5 Range: 5...65535 USB/RS232 communication timeout in milliseconds. Defines the max. time between two subsequent bytes or blocks of a transferred message. For more information about the timeout refer to the external programming documentation “Programming ModBus & SCPI”.
Timeout ETH (s)	Default value: 5 Range: 5...65535 If there was no communication between the controlling unit (PC, PLC etc.) and the device for the adjusted time, it will close the socket connection. This timeout will be ineffective as long as the option “TCP keep-alive” (see above, table for Ethernet module) is activated and “keep-alive” is working as expected within the network. Setting “0” deactivates the timeout permanently.

Submenu “Communication Protocols”

By default, the device supports two communication protocols: SCPI and ModBus RTU. These are automatically recognized from the first byte in a message. One of both can be switched off, if required.

Screen “View settings”

This screen lists an overview of all interface related settings and parameters of the currently installed module. With Ethernet modules, it also list the status of DHCP, the MAC address and the domain/host name, which can only be defined via remote control (dig. interface).

3.4.3.7 Menu “HMI Setup”

These settings refer exclusively to the control panel (HMI) and the display. The table lists all available settings for the HMI, no matter in which submenu they can be found.

Element	Description
Language	Selection of the display language between German, English, Russian or Chinese. Default setting: English
Backlight	The choice here is whether the backlight remains permanently on or if it should be switched off when no input via push buttons or rotary knob is done for 60 s. As soon as input is done, the backlight returns automatically. Furthermore, the backlight brightness can be adjusted here in 10 steps. Default setting: Always on
Status page	Switches to a different main screen layout. The user can select between two layouts which are depicted by small graphics as a preview. Also see section „3.4.6. Switching the main screen view“. Default setting: Layout 1
Key Sound	Activates or deactivates sounds when pushing a button on the HMI. It can usefully signal that the action has been accepted. Default setting: OFF
Alarm Sound	Activates or deactivates the additional acoustic signal of an alarm. See also „3.6. Alarms and monitoring“. Default setting: OFF
HMI Lock	Activates the HMI lock. See „3.7. Control panel (HMI) lock“ for details Default settings: Lock all, No

3.4.4 Adjustment limits

By default, all set values (U, I, P) are freely adjustable from 0 to 102% of the rated value.

This may be obstructive in some cases, especially for protection of applications against overcurrent. Therefore upper and lower limits for current and voltage can be set which limit the range of the adjustable set values. For power only an upper value limit can be set.







Limit Settings			
U-min=	10.00V	U-max=	75.00V
I-min=	005.0A	I-max=	100.0A
		P-max=	1.50kW

These limits apply to every kind setting a value. That also includes remote control via analog or digital interface. In remote control, the global range of 0...100% (digital) resp. 0...5 V / 0...10 V remains, only narrowed by the limits defined here.

An example: you would define the limits for a model with 80 V, 170 A and 5 kW as depicted in the screen above, with U-min = 10V and U-max = 75. In analog remote control, the active control voltage range for mode 0...10 V results as 1.25 V...9.375 V. As soon as the device is switched to analog remote control, it would put out minimum 10V, even there is nothing connected to voltage control input VSEL.

Beyond those limits, values given by digital commands are not accepted and will return an error (when using SCPI). Values given from analog control voltages are ignored (clipping).

► How to configure the adjustment limits

1. Switch off the DC output and push button  to call the setup menu.
2. Push button  to call submenu “Settings”. In the submenu navigate to “Limit Settings” and push  again.
3. In the screen you can now adjust the settings I-min, I-max, U-min, U-max and P-max with the rotary knobs. Switching between values for current and power is done with the arrow buttons  and .
4. Accept the settings with  or discard them with .



*The adjustment limits are coupled to the set values. It means, that the upper limit (-max) may not be set lower than the corresponding set value. Example: If you wish to set the limit for the current set value I-max to 120 A while the currently adjusted current set value is 150 A, then the set value first would have to be reduced to 120 A or less.
The same applies vice versa when adjusting I-min.*

3.4.5 Manual adjustment of set values

The set values for voltage, current and power are the fundamental operating possibilities of a power supply and hence the two rotary knobs on the front of the device are usually assigned two of the three values in manual operation. Default assignment is voltage and current.

The set values can only be adjusted with the **rotary knobs**.





Entering a value changes it at any time, no matter if the output is switched on or off.



When adjusting the set values, upper or lower limits may come into effect. See section „3.4.4. Adjustment limits“. Once a limit is reached, the display will show a note like “Limit: U-max” etc. or “[!]” for 1.5 seconds.

► How to adjust values U, I or P with the rotary knobs

1. First check whether the value to be changed is assigned to one of the rotary knobs.
2. With, for example, mode **UI** selected and as long as the main display is active, turn the left-hand knob to adjust voltage and the right-hand knob to adjust the current. In mode **UP**, turn the right-hand knob to adjust the power. The arrow buttons   can be used to toggle between current and power set value.
3. Any set values can be adjusted with the adjustment limits. For switching the digit to adjust, push the rotary knob that you are currently using to adjust the value. Every push moves the cursor under the digit in clockwise order:

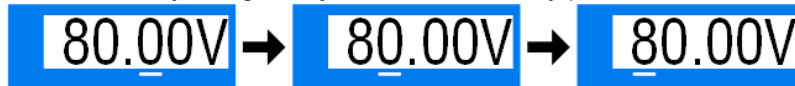

3.4.6 Switching the main screen view

The main screen, also called status page, with its set values, actual values and device status can be switched from the standard view mode with three values to a simpler mode which only shows two physical values.

The advantage of the alternative view mode is that both actual values are displayed with **bigger numbers**, so they read be read from a larger distance. Refer to „3.4.3.7. Menu “HMI Setup”“ to see where to switch the view mode in the MENU. Comparison:

Layout 1 (standard)



Layout 2 (alternative)



Differences of layout 2:



- The hidden value is shown when switching the knob assignment, which also changes the upper right half of the display
- The actual regulation mode is displayed no matter what pair of physical values is currently shown, as the example in the upper figure on the right side depicts with CV

3.4.7 The quick menu

The quick menu offers access to some feature which are also accessible from the regular menu, but here they can be used while the DC output is switched on.

The quick menu is shown when pressing the  button and looks like this:



Navigation in the menu is also done with arrow buttons  /  and .

For example, in this menu it's possible to preset the output values and to submit with button  which allows for set value steps which would not be possible when rotating a knob. Furthermore, the HMI lock can be activated here in a shorter way.

3.4.8 Switching the DC output on or off

The DC output of the device can be manually or remotely switched on and off. This can be restricted in manual operation by the control panel being locked.



Switching the DC output on during manual operation or digital remote control can be disabled by pin REM-SB of the built-in analog interface. For more information refer to 3.4.3.1 and example a) in 3.5.4.7.

► How to manually switch the DC output on or off

1. As long as the control panel (HMI) isn't fully locked press the button ON/OFF. Otherwise you are asked to disable the HMI lock first.
2. This button toggles between on and off, as long as a change isn't restricted by an alarm or the device is locked in "remote". The current condition is displayed with the green LED in button .

► How to remotely switch the DC output on or off via the analog interface

1. See section „3.5.4. Remote control via the analog interface (AI)“.

► How to remotely switch the DC output on or off via the digital interface

1. See the external documentation "Programming Guide ModBus & SCPI" if you are using custom software, or refer to the external documentation of LabView VIs or other software provided by the manufacturer.

3.5 Remote control

3.5.1 General

Remote control is possible via the built-in analog or USB port or via one of the optional interface modules of IF-AB series. Important here is that only the analog or any digital interface can be in control. One of the digital ones is the master-slave bus.

It means that if, for example, an attempt were to be made to switch to remote control via the digital interface whilst analog remote control is active (pin REMOTE = LOW) the device would report an error at the digital interface. In the opposite direction a switch-over via pin REMOTE would be ignored. In both cases, however, status monitoring and reading of values are always possible.

3.5.2 Control locations

Control locations are those locations from where the device is controlled. Essentially there are two: at the device (manual operation) and outside (remote control). The following locations are defined:

Displayed location	Description
-	If neither of the other locations is displayed then manual control is active and access from the analog or digital interfaces is allowed. This location isn't explicitly displayed
Remote	Remote control via any interface is active
Local	Remote control is locked, only manual operation is allowed.

Remote control may be allowed or inhibited using the setting "**Allow remote control**" (see „3.4.3.1. Menu "General Settings""). In inhibited condition the status "**Local**" will be displayed in the status area (lower half, middle) of the display. Activating the inhibit can be useful if the device is remotely controlled by software or some electronic device, but it's required to make adjustments at the device or deal with emergency, which would not be possible remotely.

Activating condition "**Local**" causes the following:

- If remote control via the digital interface is active ("**Remote**"), then remote control is immediately terminated and must be reactivated at the PC once "**Local**" is no longer active
- If remote control is via the analog interface is active ("**Remote**"), then remote operation is only interrupted until remote control is allowed again, because pin REMOTE continues to signal "remote control = on". Exception: if the level of pin REMOTE is changed to HIGH during the "**Local**" phase

3.5.3 Remote control via a digital interface

3.5.3.1 Selecting an interface

The standard models of series PSE 9000 3U support, in addition to the built-in USB port, the following optionally available interface modules:

Short ID	Type	Ports	Description*
IF-AB-CANO	CANopen	1	CANopen slave with generic EDS
IF-AB-RS232	RS232	1	Standard RS232, serial
IF-AB-PBUS	Profibus	1	Profibus DP-V1 slave
IF-AB-ETH1P	Ethernet	1	Ethernet TCP
IF-AB-PNET1P	ProfiNet	1	Profinet DP-V1 slave
IF-AB-MBUS	ModBus TCP	1	ModBus TCP protocol via Ethernet
IF-AB-ETH2P	Ethernet	2	Ethernet TCP, with switch
IF-AB-MBUS2P	ModBus TCP	2	ModBus TCP protocol via Ethernet, with switch
IF-AB-PNET2P	ProfiNet	2	Profinet DP-V1 slave, with switch
IF-AB-CAN	CAN	1	CAN 2.0 A / 2.0 B
IF-AB-ECT	EtherCAT	2	Basic EtherCAT slave with CoE

* For technical details of the various modules see the extra documentation "Programming Guide Modbus & SCPI"

3.5.3.2 General

With the standard models of series PSE 9000 3U, one of the plug-in and retrofittable modules listed in 3.5.3.1 can be installed. It can take over remote control of the device alternatively to the built-in USB type B on the back side or analog interface. For installation see section „2.3.11. Installation of an interface module“ and separate documentation.

The modules require little or no settings for operation and can be directly used with their default configuration. All specific settings will be permanently stored such that, after changeover between the various models, no reconfiguration will be necessary.

3.5.3.3 Programming

Programming details for the interfaces, the communication protocols etc. are to be found in the documentation “Programming Guide ModBus & SCPI“ which is supplied on the included USB stick or which is available as download from the manufacturer’s website.

3.5.4 Remote control via the analog interface (AI)

3.5.4.1 General

The built-in, 15 pole analog interface (short: AI) is on the rear side of the device offers the following possibilities:

- Remote control of current, voltage and power
- Remote status monitoring (CV, DC output on/off)
- Remote alarm monitoring (OT, OVP, OCP, OPP, PF)
- Remote monitoring of actual values
- Remote on/off switching of the DC output

Setting the **three** set values via the analog interface always takes place concurrently. It means, that for example the voltage can not be given via the AI and current and power set by the rotary knobs, or vice versa.

The OVP set value and other supervision (events) and alarm thresholds can’t be set via the AI and therefore must be adapted to the given situation before the AI is put in operation. Analog set values can be fed in by an external voltage or generated by the reference voltage on pin 3. As soon as remote control via the analog interface is activated, the values displayed will be those provided by the interface.

The AI can be operated in the common voltage ranges 0...5 V and 0...10 V in each case 0...100% of the nominal value. The selection of the voltage range can be done in the device setup. See section „3.4.3. Configuration in the setup menu“ for details.

The reference voltage sent out from Pin 3 (VREF) will be adapted accordingly and is then:

0-5 V: Reference voltage = 5 V, 0...5 V set values (VSEL, CSEL, PSEL) correspond to 0...100% nominal values, 0...100% actual values correspond to 0...5 V at the actual value outputs (CMON, VMON).

0-10 V: Reference voltage = 10 V, 0...10 V set values (VSEL, CSEL, PSEL) correspond to 0...100% nominal values, 0...100% actual values correspond to 0...10 V at the actual value outputs (CMON, VMON).

Input of excess set values (e.g. >5 V in selected 5 V range or >10 V in the 10 V range) are clipped by setting the set value at 100%.

Before you begin, please read these important notes about the use of the interface:



After powering the device and during the start phase the AI signals undefined statuses on the digital output pins such as ALARMS 1. Those must be ignored until is ready to work.

- Analog remote control of the device must be activated by switching pin REMOTE (5) first
- Before the hardware is connected that will control the analog interface, it shall be checked that it can’t provide voltage to the pins higher than specified
- Set value inputs, such as VSEL, CSEL and PSEL, must not be left unconnected (i.e. floating) during analog remote control. In case any of the set values isn’t used for adjustment, it can be tied to a defined level or connected to pin VREF (solder bridge or different), so it gives 100%

3.5.4.2 Resolution and sample rate

The analog interface is internally sampled and processed by a digital microcontroller. This causes a limited resolution of analog steps. The resolution is the same for set values (VSEL etc.) and actual values (VMON/CMON) and is 26214. Due to tolerances, the truly achievable resolution can be slightly lower.

There is furthermore a max. sample rate of 500 Hz. It means, the device can acquire analog set values and states on digital pins 500 times per second.

3.5.4.3 Acknowledging device alarms

In case of a device alarm occurring during remote control via analog interface, the DC output will be switched off the same way as in manual control. The device would indicate an alarm (see 3.6.2) in the front display and, if activated, acoustically and also signal most of them on the analog interface. Which alarms actually are signaled can be set up in the device configuration menu (see „3.4.3.1. Menu “General Settings”).

Some device alarms (OVP, OCP and OPP) have to be acknowledged. Also see „3.6.2. Device alarm handling“. Acknowledgment is done with pin REM-SB switching the DC output off and on again, means a HIGH-LOW-HIGH edge (min. 50ms for LOW), when using the default level setting for this pin.

3.5.4.4 Analog interface specification

Pin	Name	Type*	Description	Default levels	Electrical specification
1	VSEL	AI	Set voltage value	0...10 V or. 0...5 V correspond to 0..100% of U_{Nom}	Accuracy 0-5 V range: < 0.4% ***** Accuracy 0-10 V range: < 0.2% *****
2	CSEL	AI	Set current value	0...10 V or. 0...5 V correspond to 0..100% of I_{Nom}	Input impedance R_i >40 k...100 k
3	VREF	AO	Reference voltage	10 V or 5 V	Tolerance < 0.2% at $I_{max} = +5$ mA Short-circuit-proof against AGND
4	DGND	POT	Ground for all digital signals		For control and status signals
5	REMOTE	DI	Switching internal / remote control	Remote = LOW, $U_{Low} < 1$ V Internal = HIGH, $U_{High} > 4$ V Internal = Open	Voltage range = 0...30 V $I_{Max} = -1$ mA at 5 V U_{LOW} to HIGH typ. = 3 V Rec'd sender: Open collector against DGND
6	ALARMS 1	DO	Overheating or power fail alarm	Alarm= HIGH, $U_{High} > 4$ V No alarm= LOW, $U_{Low} < 1$ V	Quasi open collector with pull-up against V_{cc} ** With 5 V on the pin max. flow +1 mA $I_{Max} = -10$ mA at $U_{CE} = 0,3$ V $U_{Max} = 30$ V Short-circuit-proof against DGND
7	-	-	-	-	-
8	PSEL	AI	Set power value	0...10 V or. 0...5 V correspond to 0..100% of P_{Nom}	Accuracy 0-5 V range: < 0.4% ***** Accuracy 0-10 V range: < 0.2% ***** Input impedance R_i >40 k...100 k
9	VMON	AO	Actual voltage	0...10 V or. 0...5 V correspond to 0..100% of U_{Nom}	Accuracy 0-5 V range: < 0.4% ***** Accuracy 0-10 V range: < 0.2% *****
10	CMON	AO	Actual current	0...10 V or. 0...5 V correspond to 0..100% of I_{Nom}	at $I_{Max} = +2$ mA Short-circuit-proof against AGND
11	AGND	POT	Ground for all analog signals		For -SEL, -MON, VREF signals
12	-	-	-	-	-
13	REM-SB	DI	DC output OFF (DC output ON) (ACK alarms ****)	Off = LOW, $U_{Low} < 1$ V On= HIGH, $U_{High} > 4$ V On = Open	Voltage range = 0...30 V $I_{Max} = +1$ mA at 5 V Rec'd sender: Open collector against DGND
14	ALARMS 2	DO	Overvoltage alarm Overcurrent alarm Overpower alarm	Alarm = HIGH, $U_{High} > 4$ V No alarm = LOW, $U_{Low} < 1$ V	Quasi open collector with pull-up against V_{cc} ** With 5 V on the pin max. flow +1 mA
15	STATUS***	DO	Constant voltage regulation active	CV = LOW, $U_{Low} < 1$ V CC/CP/CR = HIGH, $U_{High} > 4$ V	$I_{Max} = -10$ mA at $U_{CE} = 0,3$ V, $U_{Max} = 30$ V Short-circuit-proof against DGND
			DC output	On = LOW, $U_{Low} < 1$ V Off = HIGH, $U_{High} > 4$ V	

* AI = Analog Input, AO = Analog Output, DI = Digital Input, DO = Digital Output, POT = Potential

** Internal V_{cc} approximately 14.3 V

*** Only one of both signals possible, see section 3.4.3.1

**** Only during remote control

***** The error of a set value input adds to the general error of the related value on the DC output of the device

3.5.4.5 Overview of the Sub-D Socket

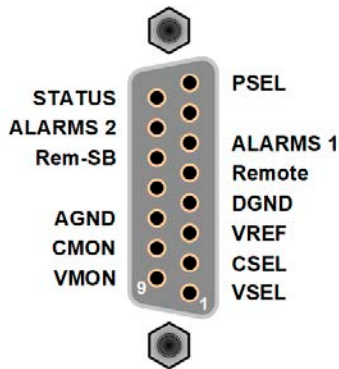

3.5.4.6 Simplified diagram of the pins

	<p>Digital Input (DI)</p> <p>The internal circuit requires that a switch with low resistance should be used (relay, switch, circuit breaker etc.) in order to send a clean signal to the DGND.</p>		<p>Analog Input (AI)</p> <p>High resistance input (impedance >40 k...100 kΩ) for an OA circuit.</p>
	<p>Digital Output (DO)</p> <p>A quasi open collector, realized as high resistance pull-up against the internal supply. In condition LOW it can carry no load, merely switch, as shown in the diagram with a relay as example.</p>		<p>Analog Output (AO)</p> <p>Output from an OA circuit, only minimally impedant. See specifications table above.</p>

3.5.4.7 Application examples

a) Switching off the DC output via the pin “REM-SB”

A digital output, e.g. from a PLC, may be unable to cleanly pull down the pin as it may not be of low enough resistance. Check the specification of the controlling application. Also see pin diagrams above.

In remote control, pin REM-SB is be used to switch the DC output of the device on and off. This function is also available without remote control being active and can on one hand block the DC terminal from being switched on in manual or digital remote control and on the other hand the pin can switch the DC output on or off, but not standalone. See below at “Remote control has not been activated”.

It’s recommended that a low resistance contact such as a switch, relay or transistor is used to switch the pin to ground (DGND).

Following situations can occur:

- **Remote control has been activated**

During remote control via analog interface, only pin “REM-SB” determines the states of the DC output, according to the levels definitions in 3.5.4.4. The logical function and the default levels can be inverted by a parameter in the setup menu of the device. See 3.4.3.1.

If the pin is unconnected or the connected contact is open, the pin will be HIGH. With parameter “Analog interface Rem-SB” being set to “Normal”, it requests “DC output on”. So when activating remote control, the DC output will instantly switch on.

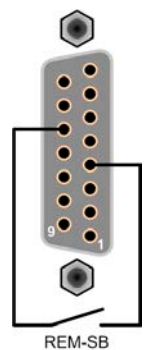

• **Remote control isn't active**

In this mode of operation pin "REM-SB" can serve as lock, preventing the DC output from being switched on by any means. This results in following possible situations:

DC output	+	Level on pin REM-SB	+	Parameter „Analog interface Rem-SB“	→	Behavior
is off	+	HIGH	+	Normal	→	The DC output isn't locked. It can be switched on by pushbutton "On/Off" (front panel) or via command from digital interface.
		LOW	+	Inverted		
	+	HIGH	+	Inverted		
		LOW	+	Normal		

In case the DC output is already switched on, toggling the pin will switch the DC output off, similar to what it does in analog remote control:

DC output	+	Level on pin REM-SB	+	Parameter „Analog interface Rem-SB“	→	Behavior
is on	+	HIGH	+	Normal	→	The DC output remains on, nothing is locked. It can be switched on or off by pushbutton or digital command.
		LOW	+	Inverted		
	+	HIGH	+	Inverted		
		LOW	+	Normal		

b) Remote control of current and power

Requires remote control to be activated (pin REMOTE = LOW)

The set values PSEL CSEL are generated from, for example, the reference voltage VREF using potentiometers for each. Hence the power supply can selectively work in current limiting or power limiting mode. According to the specification of max. 5 mA for the VREF output, potentiometers of at least 10 kΩ must be used.

The voltage set value VSEL is permanently assigned to VREF and will thus be permanently 100%.

If the control voltage is fed in from an external source it's necessary to consider the input voltage ranges for set values (0...5 V oder 0...10 V).



Use of the input voltage range 0...5 V for 0...100% set value halves the effective resolution.

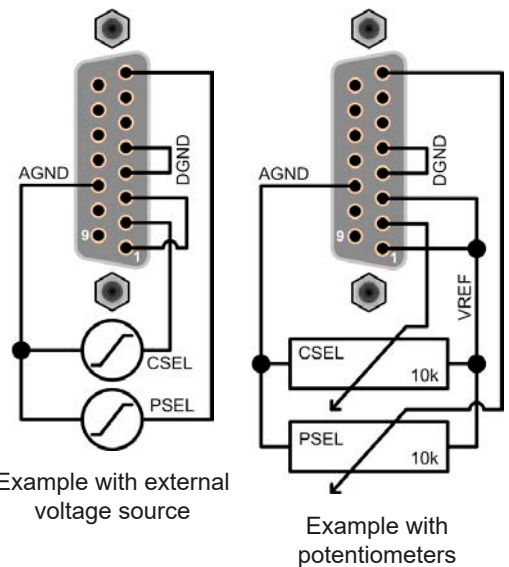

c) Reading actual values

Via the AI the output values for current and voltage can be monitored. These can be read using a standard multimeter or similar.

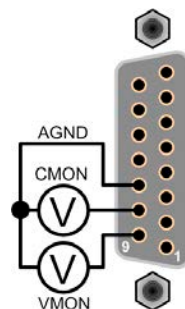

3.6 Alarms and monitoring

3.6.1 Definition of terms

Device alarms (see „3.3. Alarm conditions“) are defined as conditions like overvoltage or overtemperature, signaled in any form to the user of the device in order to take notice.

Those alarms are always indicated in the front display as readable abbreviated text, as well as status readable via digital interface when controlling or just monitoring remotely and, if activated, emitted as audible signal (buzzer). Furthermore, the most important alarms are also signaled by output pins on the analog interface.

There is furthermore an alarm history available in the submenu “Overview”. It counts alarms that occurred since the last time the unit was switched on, for statistics and later check.

3.6.2 Device alarm handling

A device alarm incident will usually lead to DC output switch-off. Some alarms must be acknowledged (see below), which can only happen if the cause of the alarm isn't persistent anymore. Other alarms acknowledge themselves if the cause has vanished, like the OT and the PF alarm.

► **How to acknowledge an alarm in the display (during manual control)**

1. Push button  once.

► **How to acknowledge an alarm on the analog interface (during analog remote control)**

1. Switch off the DC output by pulling pin REM-SB to the level that corresponds to “DC output off” switch it on again. See section „3.5.4.7. Application examples“ for levels and logic.

► **How to acknowledge an alarm in the alarm buffer/status (during manual control)**

1. Read the error buffer (SCPI protocol) or send a specific command to acknowledge, i.e. reset alarms (ModBus).





Some device alarms are configurable by adjusting a threshold:

Alarm	Meaning	Description	Range	Indication
OVP	OverVoltage Protection	Triggers an alarm if the DC output voltage reaches the defined threshold. This can be caused by the device being faulty or by an external source. The DC output will be switched off.	0 V...1.1*U _{Nom}	Display, analog IF, digital IF
OCP	OverCurrent Protection	Triggers an alarm if the DC output current reaches the defined threshold. The DC output will be switched off.	0 A...1.1*I _{Nom}	Display, analog IF, digital IF
OPP	OverPower Protection	Triggers an alarm if the DC output power reaches the defined threshold. The DC output will be switched off.	0 W...1.1*P _{Nom}	Display, analog IF, digital IF

These device alarms can't be configured and are based on hardware:

Alarm	Meaning	Description	Indication
PF	Power Fail	AC supply undervoltage. Triggers an alarm if the AC supply is out of specification or when the device is cut from supply, for example when switching it off with the power switch. The DC output will be switched off.	Display, analog IF, digital IF
OT	OverTemperature	Triggers an alarm if the internal temperature reaches a certain limit. The DC output will be switched off.	Display, analog IF, digital IF
MSP	Master-Slave Protection	Triggers an alarm if the master unit loses contact to any slave unit. The DC output will be switched off. The alarm can be cleared by reinitializing the MS system.	Display, digital interface





► How to configure the device alarms OVP, OCP and OPP

1. Switch off the DC output and push button  to call the setup menu.
2. In the menu navigate to “**Settings**” and push . Then in the submenu navigate to “**Protection Settings**” and push  again.
3. Set the limits for the equipment alarm relevant to your application if the default value of 110% of nominal is unsuitable.
4. Accept the settings with  or discard them with .



Those thresholds are reset to defaults when using the function “Reset Device” in setup menu.





► How to configure the alarm sound

1. Switch off the DC output and push button  to call the setup menu.
2. In the menu navigate to “**HMI Setup**” and push . Then in the submenu navigate to “**Alarm Sound**” and push  again.
3. In the following screen set parameter “**Alarm Sound**” to either **OFF** or **ON**.
4. Accept the settings with  or discard them with .

3.7 Control panel (HMI) lock



In order to avoid the accidental alteration of a value during manual operation the rotary knobs or the key strip of the control panel (HMI) can be locked so that no alteration will be accepted without prior unlocking. For additional safety, the panel lock can be secured by a PIN in order to only allow access from authorized personnel.

► How to lock the HMI

1. Switch off the DC terminal and push button  to call the setup menu.
2. In the menu navigate to “**HMI Setup**” and push . Then in the submenu navigate to “**HMI Lock**” and push  again.
3. Make your selection for parameter “**HMI Lock**”. With selection “**Lock all**” everything on the HMI is locked and you can’t even switch on the DC output. In order to be able to do at least that, use “**ON/OFF possible**”.
4. If required, activate the additional PIN feature with “**Enable PIN: Yes**”. In case you are not sure about the number, define a new one via “**Change PIN:**”.
5. The lock is activated as soon as you confirm your selection with . The device will automatically exit the menu and jump back to normal display with status “**Locked**” now being indicated.

If an attempt is made to alter something whilst the HMI is locked, a requester appears in the display asking if the lock should be disabled.

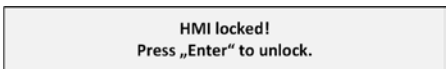
► How to unlock the HMI

1. Rotate any knob or push any button except ON/OFF.
2. This request pop-up will appear: .
3. Unlock the HMI by pushing  within 5 seconds, otherwise the pop-up will disappear and the HMI remains locked. In case the additional **PIN code lock** has been activated in the menu “**HMI Lock**”, another requester will pop up asking you to enter the **PIN** before it finally unlocks the HMI.





3.8 Loading and saving a user profile

The menu “**Profiles**” serves to select between a default profile and up to 5 user profiles. A profile is a collection of all settings and set values. Upon delivery, or after a reset, all 6 profiles have the same settings and all set values are 0. If the user changes settings or sets target values then these create a work profile which can be saved to one of the 5 user profiles. These profiles or the default one can then be switched. The default profile is read-only.

The purpose of a profile is to load a set of set values, settings limits and monitoring thresholds quickly without having to readjust these. As all HMI settings are saved in the profile, including language, a profile change can also be accompanied by a change in HMI language.





On calling up the menu page and selecting a profile the most important settings can be seen, but not changed.

► How to save the current values and settings (work profile) as a user profile

1. Switch off the DC output and push button  to call the setup menu.
2. In the menu navigate to “**Profiles**” and push .
3. In the submenu (see figure to the right) select a user profile (1-5) to save to and push  again.
4. From the selection on screen chose “**Save settings into Profile n**” and overwrite that profile with the current settings and values by confirming with .



► How to load a user profile

1. Switch off the DC output and push button  to call the setup menu.
2. In the menu navigate to “**Profiles**” and push .
3. In the submenu (see figure to the right) select a user profile (1-5) to load and push  again.
4. In the screen you can now select “**View Profile n**” in order to check the stored settings and to decide, whether this profile is going to be loaded or not. Navigate to “**Load Profile n**” and confirm with  to finally load the profile into the work profile.



3.9 Other applications

3.9.1 Parallel operation in master-slave (MS)

Multiple devices of same kind and model can be connected in parallel in order to create a system with higher total current and hence higher power. For master-slave operation, the units are usually connected with their DC outputs, their Share bus and their digital master-slave bus.

The master-slave bus is a digital bus which makes the system work as one big unit regarding adjusted values, actual values and status.

The Share bus is intended to balance the units dynamically in their output voltage, i.e. in CV mode. In order for this bus to work correctly, at least the DC minus poles of all units have to be connected, because DC minus is the reference for the Share bus.

Principle view without load:

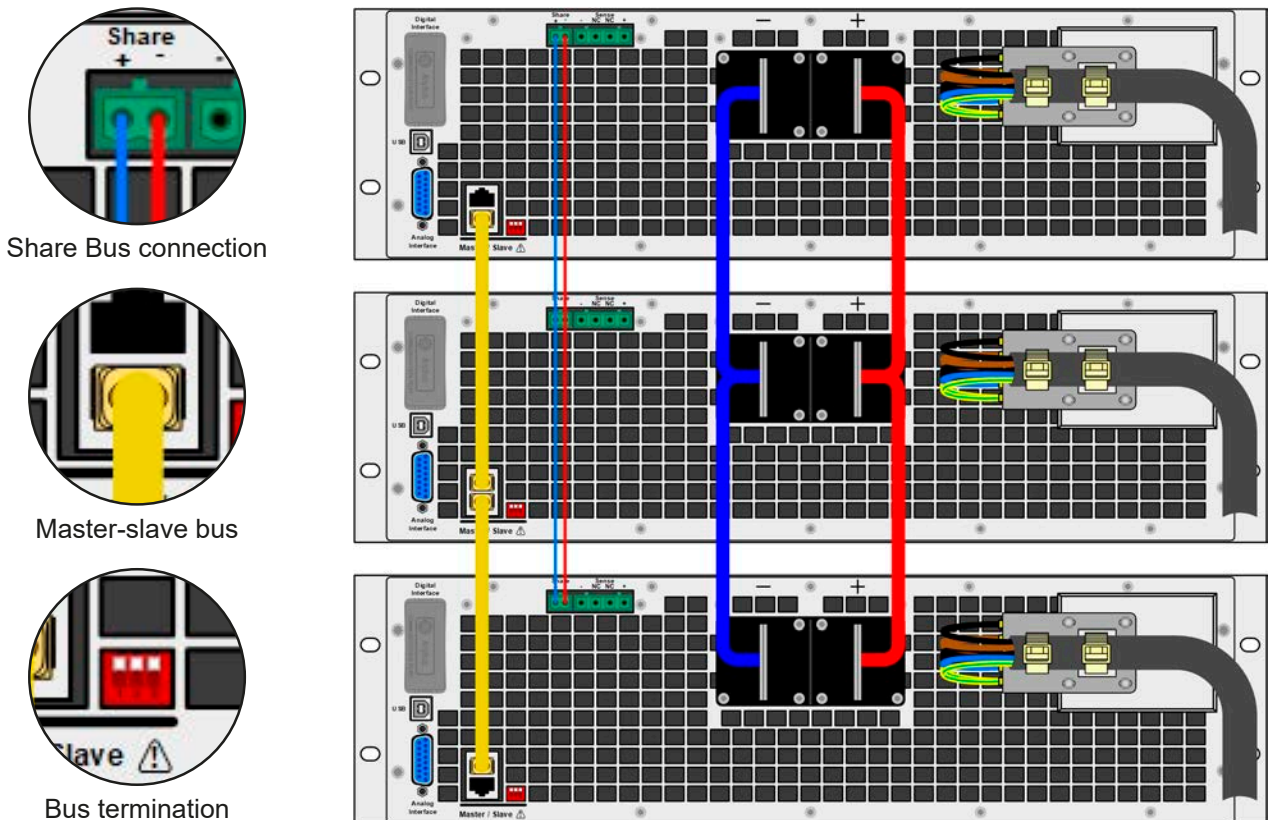

3.9.1.1 Restrictions

Compared to normal operation of a single device, master-slave operation has some *restrictions*:

- The MS system reacts differently to alarm situations than a single unit (see below in 3.9.1.6)
- Using the Share bus makes the system react as dynamic as possible, but it's still not as dynamic as single unit operation
- Connection to models with identical ratings, but from other series, is supported

3.9.1.2 Wiring the DC outputs

The DC output of every unit in the parallel operation is simply connected to the next unit using cables with cross section according to the maximum current and with short as possible length.

3.9.1.3 Wiring the Share bus

The Share bus is wired from unit to unit with an ideally twisted pair of cables with non-critical cross section. We recommend to use 0.5 mm² to 1.0 mm².



- The Share bus is poled. Take care for correct polarity of the wiring!
- In order for the Share bus to work correctly it requires at least to connect all DC minus terminals of the devices



A max. of 16 units can be connected via Share bus.

3.9.1.4 Wiring and set-up of the digital master-slave bus

The master-slave connectors are built-in and can be connected via network cables (\geq CAT3, patch cable). After this, MS can be configured manually (recommended) or by remote control. The following applies:

- A maximum of 16 units can be connected via the bus: 1 master and up to 15 slaves.
- Connection only between devices of same type, like power supply to power supply, and of the same ratings, such as PSE 9080-170 3U to PSE 9080-170 3U or to PSI 9080-170 3U.
- Units at the end of the bus must be terminated (see below)



The master-slave bus must not be wired using crossover cables!

Later operation of the MS system implies:

- The master unit displays, or makes available to be read by the remote controller, the sum of the actual values of all the units
- The ranges for setting the values, adjustment limits, protections (OVP etc.) and user events (UVD etc.) of the master are adapted to the total number of units. Thus, if e.g. 5 units each with a power of 5 kW are connected together to a 25 kW system, then the master can be set in the range 0...25 kW
- Slaves are no operable as long as being controlled by the master
- Slave units will show the alarm "MSP" in the display as long as they not have been initialised by the master. The same alarm is signalled after a connection drop to the master unit occurred

► How to connect the digital master-slave bus

1. Switch off all units that are to be connected and connect them with network cables (CAT3 or better, cables not included). It doesn't matter which of the two master-slave connection sockets (RJ45, backside) is connected to the next unit.
2. Depending on the desired configuration the units can then be connected at the DC side. The two units at the beginning and end of the chain may require bus termination, depending on the total number of units or when long connection cables are used. This is achieved using a 3-pole DIP switch which is positioned on the back side of the unit next to the MS connectors.



Now the master-slave system has to be configured on each other unit. It's recommended to configure first all the slave units and then the master unit.

► Step 1: Configuring all slave units

1. Switch off the DC output and push button **Menu** to call the setup menu. Push **Enter** again to enter submenu "Settings".
2. In the submenu navigate to "General Settings" and push **Enter** once again.
3. Use arrow button **↓** to navigate to parameter "Master-slave mode" and select parameter "Slave" by using the right-hand rotary knob.
4. Accept the settings with **Enter** or discard them with **ESC**.

The slave is now configured. Repeat this step for every other unit that is going to be used as slave.

► Step 2: Configuring the master unit

1. Switch off the DC output and push button **Menu** to call the setup menu. Push **Enter** again to enter submenu "Settings".
2. In the submenu navigate to "General Settings" and push **Enter** once again.
3. Use arrow button **↓** to navigate to parameter "Master-slave mode" and select setting "Master" by using the right-hand rotary knob.
4. Accept the settings with **Enter** or discard them with **ESC**.

► Step 3: Initializing the master

The master-slave system must now be initialized, which is done automatically after the master unit has been activated for MS or when rebooting. In the main page, after quitting the setting menus, a pop-up will appear:

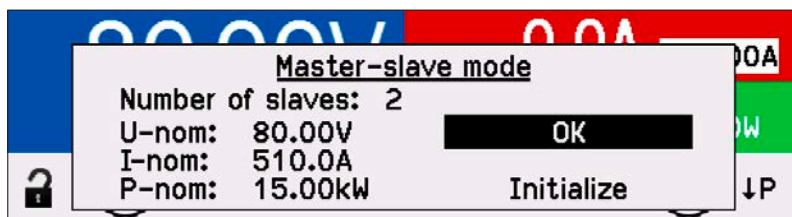

The example screen shows that two slaves have been initialized, hence a total of three units with 510 A of current and 15 kW of power capability. The MS system consists of three units of model PSE 9080-170.



As long as MS mode is activated, the initializing process of the master and the master-slave system will be repeated each time the units are powered. Manual initialization can be started anytime via the MENU in "Settings -> Repeat master init."

3.9.1.5 Operating the master-slave system

After successful configuration and initialization of the master and slave units, they will show their status in the displays. The master shows "M" in the status area, while the slaves will show "S 1" (slave with address 1) etc., as well as "Remote: MS", which means they are under remote control by the MS master.

The slaves can no longer be controlled manually or remotely, neither via the analog nor via digital interfaces. They can, if needed, be monitored by reading actual values and status.

The display on the master unit changes after initialization and all set values are reset. The master now displays the set and actual values of the total system. Depending on the number of units, the total current and power will multiply. The following applies:

- The master can be treated like a standalone unit
- The master shares the set values across the slaves and controls them
- The master is remotely controllable via the analog or digital interfaces
- All settings for the set values U, I and P (supervision, limits etc.) are adapted to the new system related ratings
- All initialised slaves will reset any limits (U_{Min} , I_{Max} etc.), supervision thresholds (OVP, OPP etc.) to default values, so these don't interfere the control by the master



In order to easily restore all these settings to what was before activating MS operation, it's recommended to make use of the user profiles (see „3.8. Loading and saving a user profile“)

- If one or more slaves report a device alarm, it will be displayed on the master and must be acknowledged there so that the slave(s) can continue their operation. Since an alarm causes the DC output to be switched off and it can only be reinstated automatically after PF or OT alarms, it can be required to switch it on again by the operator or by a remote control software.

- Loss of connection to any slave will result in shutdown of all DC outputs, as a safety measure, and the master will report this situation in the display with a pop-up:

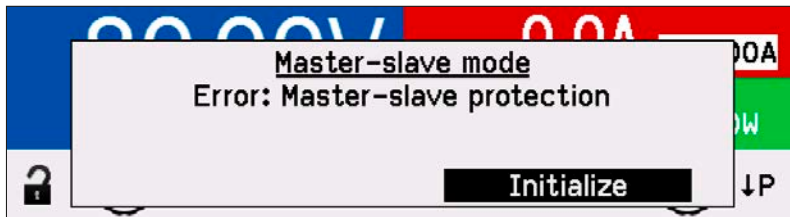

Then the MS system has to be re-initialised with button ENTER, either with or without re-establishing connection to the disconnected unit(s) before.

- All units, even the slaves, can be externally shut down on the DC outputs using the pin REM-SB of the analog interface. This can be used as some kind of emergency off, where usually a contact (maker or breaker) is wired to this pin on all units in parallel.

3.9.1.6 Alarms and other problem situations

Master-slave operation, due to the connection of multiple units and their interaction, can cause additional problem situations which do not occur when operating individual units. For such occurrences the following regulations have been defined:

- Generally, if the master loses connection to any slave, it will generate an MSP (master-slave protection) alarm, pop up a message on the screen and switch off its DC output. The slaves will fall back to single operation mode, but also switch off their DC output. The MSP alarm can be deleted by either initialising the master-slave system again. This can be done either in the MSP alarm pop-up screen or in the MENU of the master or via remote control. Alternatively, the alarm is also cleared by deactivating master-slave on the master unit
- If one or more slave units are cut from AC supply (power switch, blackout, supply undervoltage) and come back later, they're not automatically initialised and included again in the MS system. Then the init has to be repeated.
- If the master unit is cut from AC supply (power switch, blackout) and comes back later, the unit will automatically initialise the MS system again, finding and integrating all active slaves. In this case, MS can be restored automatically.
- If accidentally multiple or no units are defined as master the master-slave system can't be initialised

In situations where one or multiple units generate a device alarm like OV etc. following applies:

- Any alarm of a slave is indicated on the slave's display and on the master's display
- If multiple alarms happen simultaneously, the master only indicates the most recent one. In this case, the particular alarms can be read during runtime from the slaves' displays or via digital interface, if the slaves are remotely supervised.
- All units in the MS system supervise their own values regarding overvoltage, overcurrent and overpower and in case of alarm they report the alarm to the master. In situations where the current is probably not balanced between the units, it can occur that one unit generates an OCP alarm though the global OCP limit of the MS system was not reached. The same can occur with the OPP alarm.

3.9.1.7 Important to know



In case one or several units of a parallel system are not going to be used and remain switched off, depending on the number of active units and the dynamics of the operation it may become necessary to disconnect the inactive units from the Share bus, because even when not powered the units can have a negative impact on the Share bus due to their impedance.

3.9.2 Series connection

Series connection of two or multiple devices is basically possible. But for reasons of safety and isolation, some restrictions apply:



- Both, negative (DC-) and positive (DC+) output poles, are connected to PE via type X capacitors
- None DC minus pole of any unit in the series connection must have a potential against ground (PE) higher than specified in the technical data! The maximum allowed potential shift varies from model to model and is different for DC plus and DC minus
- The Share Bus must not be wired and used!
- Remote sensing must not be used!
- Series connection is only allowed with devices of the same kind and model, i.e. power supply with power supply, like for example PSE 9080-170 3U with PSE 9080-170 3U or also PS 9080-170 3U or PSI 9080-170 3U

Series connection in Master-Slave mode isn't supported. It means, all units have to be controlled separately regarding set values and DC output status, whether it's manual control or remote control (digital or analog).

Due to the max. allowed potential shift on the DC output certain models are not allowed for series connection at all, like the 1000 V model, because the DC plus there is only insulated up to 1500 V. On the contrary, two 500 V models are qualified for series connection.

Analog interfaces on the units in serial connection can be connected in parallel, because they are galvanically isolated. It's also allowed to ground the GND pins of the analog interfaces connected in parallel, which may happen automatically, when connecting them to a controlling device such as a PC, where grounds are directly tied to PE.

In digital remote control, an almost synchronous control can be achieved by using any available Ethernet interface module and sending message as broadcast, so they address multiple units at once.

3.9.3 Operation as battery charger

A power supply can be used as a battery charger, while following has to be considered:

- No false polarity protection inside! Connecting a battery with false polarity will damage the power supply severely, even if it's not powered.
- All models of this series have an internal base load in form of a high resistance resistor. It will slowly, but steadily discharge a battery if left connected permanently, no matter if the device is switched on or off.

3.9.4 Two quadrants operation (2QO)

3.9.4.1 Introduction

This way of operating refers to the use of a source, in this case a power supply of series PSE 9000 3U (only from revision 2, see type label), and a sink, in this case a series ELR 9000 or series EL 9000 B electronic load. The source and the sink function alternatively in order to test a device, such as a battery, by deliberately charging and discharging it as part of a functional or final test.

The user can decide whether the system is operated manually or the power supply only as the dominant unit or both devices should be controlled by PC. We recommend to focus on the power supply, which is intended to control the load via the Share Bus connection. The two quadrants operation is only suitable for constant voltage operation (CV).

Clarification:

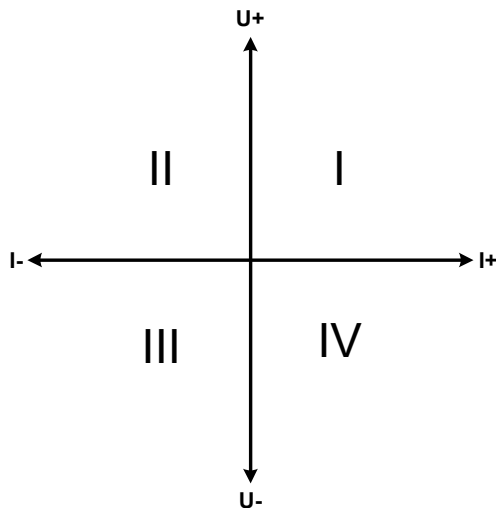
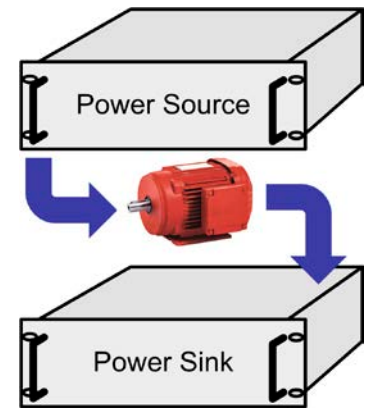

A combination of source and sink can only map the quadrants I + II. This means that only positive voltages are possible. The positive current is generated by the source or application and the negative current flows into the load.

The maximum approved limits for the application should be set in the power supply. This can be done via the interface. The electronic load should preferably be in operating mode CV. The load will then, using the Share Bus, control the output voltage of the power supply.

Typical applications:

- Fuel cells
- Capacitor tests
- Motor driven applications
- Electronic tests where a high dynamic discharge is required.

3.9.4.2 Connecting devices to a 2QO

There are a number of possibilities to connect source(s) and sink(s) to make a 2QO:

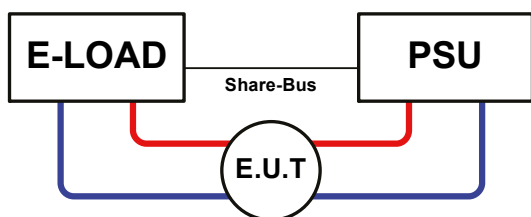

Configuration A:

1 e-load and 1 power supply, plus 1 test object (E.U.T).

This is the most common configuration for 2QO. The nominal values for U, I and P of the two devices should match, such as ELR 9080-170 and PSE 9080-170 3U. The system is controlled by the power supply, which has to be set to "Master" in the setup menu (parameter "Master-slave mode").

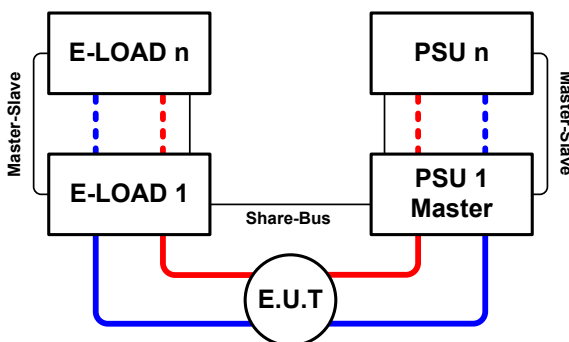

Configuration B:

Multiple e-loads and Multiple power supplies, plus 1 test object (E.U.T), for raising the total performance.

The combination of load units and power supply units each create a block, a system with certain power. Here it's also necessary to match the nominal values, but at least the voltage of the two systems, i.e. an 80 V DC input of the loads to a max. 80 V DC output of the power supplies. The max. number of 16 units can't be exceeded. Regarding the Share bus connection, all e-load units have to be slaves, while one of the PSUs has to be set as master.

3.9.4.3 Settings on the devices

The master-slave settings in the MENU of the load device(s) also affect the Share bus. For correct 2QO operation, all involved load units must be slaves on the Share bus. This is achieved by setting the master-slave mode to OFF or SLAVE, depending on if there is digital master-slave in use or not. For the one load that is master (setting: MASTER) in the master-slave system the additional parameter "PSI/ELR system" resp. "PSI/EL system" has to be activated.

On any of the power supplies, but preferably PSU 1, you need to set parameter "Master-slave mode" to MASTER.

For safety of the connected E.U.T / D.U.T and to prevent damage, we recommend to adjust supervision thresholds like OVP, OCP or OPP on all units to the desired levels, which will then switch off the DC output resp. the DC input in case of excess.

3.9.4.4 Restrictions

After all electronic loads have been connected to the Share bus with one power supply as master, they can't limit their input voltage anymore to what you adjust as "U set" on the device. The correct voltage level comes from the 2QO master unit (here: a power supply) and has to be adjusted there.

3.9.4.5 Application example

Charging and discharging a battery with 24 V/400 Ah, using configuration A from above.

- Power supply PSE 9080-170 3U with: $I_{\text{Set}} = 40 \text{ A}$ (charging current, 1/10 of Ah), $P_{\text{Set}} = 5000 \text{ W}$
- Electronic load ELR 9080-170 set to: $I_{\text{Set}} = \text{max. discharging current of the battery (eg. 100 A)}$, $P_{\text{Set}} = 3500 \text{ W}$, plus probably UVD = 20 V with event type "Alarm" to stop discharging at a certain low voltage threshold
- Assumption: battery has a voltage of 26 V at test start
- DC input(s) and DC output(s) of all units switched off



In this combination of devices it's recommended to always switch on the DC output of the source first and then the DC input of the sink.

1. Discharge of the battery to 24 V

Setup: Voltage on the power supply set to 24 V, DC output of power supply and DC input of load activated

Reaction: the e-load will load the battery with a maximum current of 100 A in order to discharge it to 24 V. The power supply delivers no current at this moment, because the battery voltage is still higher than what is adjusted on the power supply. The load will gradually reduce the input current in order to maintain the battery voltage at 24 V. Once the battery voltage has reached 24 V with a discharge current of approximately 0 A, the voltage will be maintained at this level by charging from the power supply.



The power supply determines the voltage setting of the load via the Share bus. In order to avoid deep discharge of the battery due to accidentally setting the voltage on the power to a very low value, it's recommended to configure the undervoltage detection feature (UVD) of the load, so it will switch off the DC input when reaching minimum allowed discharge voltage. The settings of the load, as given via the Share bus, can't be read from the load's display.

2. Charging the battery to 27 V

Setup: Voltage on the power supply set to 27 V

Reaction: the power supply will charge the battery with a maximum current of 40 A, which will gradually reduce with increasing voltage as a reaction to the changing internal resistance of the battery. The load absorbs no current at this charging phase, because it's controlled via the Share bus and set to a certain voltage, which is still higher than the actual battery voltage and the actual output voltage of the power supply. When reaching 27 V, the power supply will deliver only the current needed to maintain battery voltage.

4. Service and maintenance

4.1 Maintenance / cleaning

The device needs no maintenance. Cleaning may be needed for the internal fans, the frequency of cleanse is depending on the ambient conditions. The fans serve to cool the components which are heated by the inherent power loss. Heavily dirt filled fans can lead to insufficient airflow and therefore the DC output would switch off too early due to overheating or possibly lead to defects.

Cleaning the internal fans can be performed with a vacuum cleaner or similar. For this the device needs to be opened.

4.2 Fault finding / diagnosis / repair

If the equipment suddenly performs in an unexpected way, which indicates a fault, or it has an obvious defect, this can not and must not be repaired by the user. Contact the supplier in case of suspicion and elicit the steps to be taken.

It will then usually be necessary to return the device to the supplier (with or without guarantee). If a return for checking or repair is to be carried out, ensure that:

- the supplier has been contacted and it's clarified how and where the equipment should be sent.
- the device is in fully assembled state and in suitable transport packaging, ideally the original packaging.
- a fault description in as much detail as possible is attached.
- if shipping destination is abroad, the necessary customs papers are attached.

4.2.1 Firmware updates



Firmware updates should only be installed when they can eliminate existing bugs in the firmware in the device or contain new features.

The firmware of the control panel (HMI), of the communication unit (KE) and the digital controller (DR), if necessary, is updated via the rear side USB port. For this the software EA Power Control is needed which is included with the device or available as download from our website together with the firmware update, or upon request.

However, be advised not to install updates promptly. Every update includes the risk of an inoperable device or system. We recommend to install updates only if...

- an imminent problem with your device can directly be solved, especially if we suggested to install an update during a support case
- a new feature has been added which you definitely want to use. In this case, the full responsibility is transferred to you.

Following also applies in connection with firmware updates:

- Simple changes in firmwares can have crucial effects on the application the devices are used in. We thus recommend to study the list of changes in the firmware history very thoroughly.
- Newly implemented features may require an updated documentation (user manual and/or programming guide, as well as LabView VIs), which is often delivered only later, sometimes significantly later

4.3 Calibration (readjustment)

4.3.1 Preface

The devices of series PSE 9000 feature a function to re-adjust the most important DC output related values, which can help in case these values have moved out of tolerance. The procedure is limited to compensate small differences of up to 1% or 2% of the ratings. There are several reasons which could make it necessary to readjust a unit: component aging, component deterioration, extreme ambient conditions, high frequent use.

In order to determine if a value is out of tolerance, the parameter must be verified first with measurement tools of high accuracy and with at least half the error of the PSE device. Only then a comparison between values displayed on the PSE device and true DC output values is possible.

For example, if you want to verify and possibly readjust the output current of model PSE 9080-510 3U which has 510 A maximum current, stated with a max. error of 0.2%, you can only do that by using a high current shunt with max. 0.1% error or less. Also, when measuring such high currents, it's recommended to keep the process short, in order to avoid the shunt heating up too much. It's furthermore recommended to use a shunt with at least 25% reserve.

When measuring the current with a shunt, the measurement error of the multimeter on the shunt adds to the error of the shunt and the sum of both must not exceed the max. error of the device under calibration.

4.3.2 Preparation

For a successful calibration and readjustment, a few tools and certain ambient conditions are required:

- A measurement device (multimeter) for voltage, with a max. error of half the PSE's voltage error. That measurement device can also be used to measure the shunt voltage when readjusting the current
- If the current is also going to be calibrated: a suitable DC current shunt, ideally specified for at least 1.25 times the max. output current of the PSE and with a max. error that is half or less than the max. current error of the PSE device
- Normal ambient temperature of approximately 20-25°C
- An adjustable load, such as an electronic load, which is capable of consuming at least 102% of the max. voltage and current of the PSE device

Before you can start calibrating, a few measures have to be taken:

- Let the PSE device warm up in connection with the voltage / current source
- In case the remote sensing input is going to be calibrated, prepare a cable for the remote sensing connector to DC output, but leave it yet unconnected
- Abort any form of remote control, deactivate master-slave mode, set device to **U/I** mode
- Install the shunt between PS device and load and make sure the shunt is cooled somehow
- Connect external measurement device to the DC output or to the shunt, depending on whether the voltage is going to be calibrated first or the current

4.3.3 Calibration procedure

After the preparation, the device is ready to be calibrated. From now on, a certain sequence of parameter calibration is important. Generally, you don't need to calibrate all three parameters, but it's recommended to do so.

Important:



- *It's recommended to do the calibration of current before any voltage calibration*
- *When calibrating the voltage, the input "Sense" on the rear of the device must be disconnected*
- *During the calibration, the user is asked to enter measured values. If these value differ too much from the value measured by the device or wrong values are entered, the calibration fails and has to be repeated.*

The calibration procedure, as explained below, is an example with model PSE 9080-170 3U. Other models are treated the same way, with values according to the particular PSE model and the required load.

4.3.3.1 Calibrating the set values

► How to calibrate the DC output voltage

1. Connect a multimeter to the DC output. Connect a load and set it to approximately 5% of the nominal current of the power supply as load current, in this example ≈ 8 A.
2. In the display enter the setup menu with **Menu**, then push button **Enter**. In the submenu navigate to “**Calibrate Device**”. Push **Enter** again.
3. In the next screen select “**Voltage calibration**” + **Enter**, then “**Calibrate output value**” + 2x **Enter**. The power supply will switch the DC output on, set a certain output voltage and start to measure it (**U-mon**).
4. The next screen requests you to enter the measured output voltage from the multimeter at **Measured data=**. Enter it using the right-hand rotary knob, just like would adjust a set value. Assure yourself the value is correct and submit with **Enter**.
5. Repeat point 4. for the next three steps (total of four steps).



► How to calibrate the DC output current

1. Set the load to >100% nominal current of the PSE device, for the sample model with 170 A let's say 173 A.
2. In the display enter the setup menu with **Menu**, then push button **Enter**. In the submenu navigate to “**Calibrate Device**”. Push **Enter** again.
3. In the next screen select “**Current calibration**” + **Enter**, then “**Calibrate output value**” + 2x **Enter**. The device will switch on the DC output, set a certain current limit while loaded by the load or sink and start to measure the output current (**I-mon**).
4. The next screen requests you to enter the output current **Measured data=** measured with the shunt. Enter it using the right-hand rotary knob, just like would adjust a set value. Assure yourself the value is correct and submit with **Enter**.
5. Repeat point 4. for the next three steps (total of four steps).

4.3.3.2 Calibrating the remote sensing

In case you are generally using the remote sensing feature, it's recommended to also readjust this parameter for best results. The procedure is identical to the calibration of voltage, except for it requires to have the sensing connector (Sense) on the rear to be plugged and connected with correct polarity to the DC output of the PSE.

► How to calibrate the DC output voltage for remote sensing

1. Connect a load and set it to approximately 3% of the nominal current of the power supply as load current, in this example ≈ 5 A. Connect the remote sensing input (Sense) to the load with correct polarity.
2. Put external multimeter in DC connection on the load.
3. In the display enter the setup menu with **Menu**, then push button **Enter**. In the submenu navigate to “**Calibrate Device**”. Push **Enter** again.
4. In the next screen select “**Sense volt. calibration**” + **Enter**, then “**Calibrate output value**” + 2x **Enter**.
5. The next screen requests you to enter the measured sensing voltage at **Measured data=**. Enter it using the right-hand rotary knob, just like would adjust a set value. Assure yourself the value is correct and submit with **Enter**.
6. Repeat point 5. for the next three steps (total of four steps).

4.3.3.3 Calibrating the actual values

Actual values of output voltage (with and without remote sensing) and output current are calibrated almost the same way as the set values, but here you don't need to enter anything, just confirm the displayed values. Please proceed the above steps and instead of "Calibrate output value" select "Calibrate actual value" in the submenus. After the device shows measured values on display, wait at least 2s for measured value to settle and then simply confirm with , until you are through all steps.

4.3.3.4 Save calibration data

After calibration you may furthermore enter the current date. To do so, navigate to menu item "Set calibration date" and enter the date in format YYYY / MM / DD and submit with .

Last but not least save the calibration data permanently confirming menu item "Save and exit" with .



Leaving the calibration selection menu without saving via "Save and exit" will discard calibration data and the procedure would have to be repeated!

5. Contact and support

5.1 Repairs

Repairs, if not otherwise arranged between supplier and customer, will be carried out by the manufacturer. For this the device must generally be returned to the manufacturer. No RMA number is needed. It's sufficient to package the equipment adequately and send it, together with a detailed description of the fault and, if still under guarantee, a copy of the invoice, to the following address.

5.2 Contact options

Questions or problems with operation of the device, use of optional components, with the documentation or software, can be addressed to technical support either by telephone or e-Mail.

Address	e-Mail	Telephone
EA Elektro-Automatik GmbH Helmholtzstr. 31-37 41747 Viersen Germany	Technical support: support@elektroautomatik.com All other topics: ea1974@elektroautomatik.com	Switchboard: +49 2162 / 37850 Support: +49 2162 / 378566



Elektro-Automatik

EA Elektro-Automatik GmbH & Co. KG

Development - Production - Sales

Helmholtzstraße 31-37

41747 Viersen

Germany

Fon: +49 2162 / 37 85-0

Mail: ea1974@elektroautomatik.com

Web: www.elektroautomatik.com