



操作指南
Operating guide

PSI 8000 3U HS PV
DC High Efficiency Power Supply
for Photovoltaics
高效直流光伏电源



PSI 8600-70 3U HS PV:	09 901 444
PSI 81000-30 3U HS PV:	09 901 438
PSI 81500-30 3U HS PV:	09 901 439

关于

Elektro-Automatik GmbH & Co. KG

Helmholtzstrasse 31-33

41747 Viersen

Germany

电话: +49 2162 / 37850

传真: +49 2162 / 16230

网址: www.elektroautomatik.cn

邮箱: ea1974@elektroautomatik.cn

© Elektro-Automatik

严禁再版、复印或部分错误地使用该操作指南，否则将承担该行为导致的法律后果。

 **有生命危险!**

危险电压

本产品输出电压可能上升至危险级别 (>60V_{DC})!

产品上所有带电元件必须有外遮盖。输出端的所有操作必须在产品与主电源（电源开关关闭）断开时才能执行，且可只有受过训过电流危险知识的专业人员执行此类操作。负载与本产品间的任何连接必须有防碰擦装置。连到功率输出端的应用设备必须配置好，并且有保险丝熔断保护，这样可防止使用过程中由于过载或误操作损坏产品或更严重事情发生。

 **注意!**

产品或输出关闭后，直流输出端在一定时间内仍存在危险电压!

 **请谨记**

- 请仅在铭板标示电压下操作本产品。
- 请勿将任何机械零件，特别是金属件，插入通风孔内。
- 请不要在本产品周围使用任何液体物质，以免进入产品内。
- 请勿将高于电源供应器额定电压的电压源连接到产品上。
- 从后板插槽安装接口卡时，请遵循一般防静电规则。
- 只能在产品完全关闭（电源开关为关闭状态）后插入和取出接口卡。
- 产品老化以及超负荷使用都可能导致如按钮、旋钮类的产品控制件操作不稳定。
- 请勿将电压源反接到直流输出端！产品可能会被损坏。
- 请勿将那些可能会产生高于产品额定电压的电压源连到直流输出端！

	页码
1. 简介	6
2. 技术规格	6
2.1 控制面板和显示器	6
2.2 各型号规格参数	7
3. 产品描述	8
3.1 各面视图	8
3.2 供应清单	11
4. 一般信息	11
4.1 序言/安全警告	11
4.2 制冷	11
4.3 打开产品	11
4.4 冗余操作	11
5. 安装	11
5.1 目检	11
5.2 输入端连接（单机）	11
5.3 输入端的连接（多台机）	11
5.4 输入保险丝	11
5.5 直流输出端	11
5.5.1 输出端类型	12
5.6 输出端接地	12
5.7 “Sense”（远程感测）端	12
5.8 “Share”（共享）端	12
5.9 接口卡插槽	12
6. 操作	13
6.1 显示	13
6.2 使用符号	13
6.3 各显示元素简介	13
6.4 打开产品	14
6.5 打开功率输出	14
6.6 调节设定值	14
6.7 转换按钮面板	15
6.8 锁定控制面板	15
6.9 控制定位模式	15
6.10 转至函数管理器	15
6.11 激活菜单	16
6.12 参数页	16
6.13 报警、警告和信号提示	16
6.14 报警和警告的确认	16
6.15 函数管理器	17
6.15.1 配置函数	17
6.15.2 函数布局	17
6.15.3 配置序列	17
6.15.4 与序列有关的参数	17
6.15.5 定义序列点	17
6.15.6 函数运行时的显示	18
6.15.7 函数管理器的控制	18
7. 产品设置	19
7.1 定义操作参数	20
7.2 预定义预设清单	20
7.3 调节极限	20
7.4 配置控制面板	21
7.5 配置图显	22
7.6 监控	22
7.6.1 电压的监控	22
7.6.2 电流的监控	23
7.6.3 阶跃响应监控	24
7.7 恢复至默认配置	25
7.8 激活光伏功能	25
7.9 解锁U/I/R运行模式	25
7.10 锁定产品配置	26

	页码
8. 特殊特征	26
8.1 用电源开关打开	26
8.2 用电源开关关闭	26
8.3 转至远程控制模式	26
8.4 过压报警	26
8.5 过温	26
8.6 调整电压、电流和功率	26
8.7 远程感测被激活	27
8.8 市电出现欠压或过压	27
8.9 连接不同类型的负载	27
9. 插拔式接口卡	28
9.1 一般信息	28
9.2 配置接口卡	28
10. 内置模拟接口	28
10.1 一般信息	28
10.2 引脚图	28
10.3 内部接口卡的设定	29
10.4 应用举例	29
10.5 模拟接口引脚规格	31
11. PV - 太阳能电池板的模拟	32
11.1 特殊条件	32
11.2 设置和操作	32
11.3 提示和限制条件	32
12. HS - 高速跃变	33
12.1 限定条件	33
12.2 术语解释	33
12.3 基本操作指南	33
12.4 1500V型号的特殊说明	33
12.5 可变技术参数	34
13. 其它应用	34
13.1 共享总线模式下的并联	34
13.2 串联	34
14. 其它附件和选项功能	34
14.1 附件和选项	34
14.2 固件更新	35
14.3 选项：内阻	35
14.4 连网	36

1. 简介

PSI 8000 3U HS PV 系列高效电源供应器，装于19“拉拔式外壳内，是测试系统和工业控制设备的理想选择。

除具备电源供应器的标准功能外，用户还可定义和恢复设定值的预设值，用可定义极限监控设定值和实际值，或者用函数管理器为预设参数创建函数列。

还有各种数字接口卡可选，这些接口卡通过电脑可执行更宽范围的控制和监控功能。另外还有一种扩展卡，即隔离模拟接口卡-IF-A1，通过外部手段，如PLC-可编程控制器，可对产品进行控制。

通过接口卡的使用可轻易地将产品整合于现有系统内，且根本不需配置接口卡或仅需配置少数设定值。

本系列所有型号具有一共同特征：带可调功率调整电路，以及并联时实现电流对称分布的“Share Bus”端子。

本产品还配有HS(高速跃变)和PV(光伏模拟)选项功能，与标准电源型号相比具有更高的动态特性，并能为太阳能逆变器量产的受试阶段提供典型的运行测试。PV选项根据特定的特性曲线可控制电源。

主功能一览：

- 设定0...100%范围内的电压、电流和功率
- 设定0...100%范围内的功率
- 0...110% U_{Nom} 可调过压阈值
- 可选插拔式接口卡（CAN, USB, RS232, IEEE/GPIB, 模拟, Ethernet/LAN, Profibus）
- 可选外部控制和监测用模拟接口
- 功率级别：10kW 或 15kW
- 温控风扇
- 状态（OT, OVP, CC, CV）指示灯
- 监控函数
- 函数管理器
- 可调内阻（选项）
- 高速跃变
- 共享总线下可并联连接
- PV选项功能下模拟太阳能电池板

2. 技术规格

2.1 控制面板和显示器

型号

显示器：128x64点阵图形显示器
操作控制件：5个按钮，2个带按钮功能的旋钮

显示格式

额定值限定最大可调范围。

电压、电流和功率实际值与设定值同时显示，过压阈值设定值则分开显示。

电压的显示

分辨率：4位数
格式：0.0...999.9V
0V...9999V

电流的显示

分辨率：4位数
格式：0.00A...99.99A

功率的显示

分辨率：4位数
格式：0.00kW...9.999kW

阻值的显示

（仅当“内阻控制”解锁情况下）
分辨率：4位数
格式：0.0 Ω ...999.9 Ω
0 Ω ...9999 Ω

时间的显示

时间以4种自动转换的范围显示。

分辨率：

范围1：2ms to 9.999 s
范围2：10ms to 59.99s
范围3：1:00m to 59:59min
范围4：1:00h to 99:59h

精确度：

范围1：2ms
范围2：10ms
范围3：1s
范围4：1 min

2.2 各型号规格参数

	PSI 8600-70 3U HS PV	PSI 81000-30 3U HS PV	PSI 81500-30 3U HS PV
电源输入			
输入电压	340...460V AC	340...460V AC	340...460V AC
要求相数	L1, L2, L3, PE	L1, L2, L3, PE	L1, L2, L3, PE
输入频率	45...65Hz	45...65Hz	45...65Hz
输入保险丝	6x T16A	4x T16A	6x T16A
输入电流	最大28A	最大28A	最大28A
功率因数	> 0.99	> 0.99	> 0.99
输出 - 电压			
额定电压 U_{Nom}	600V	1000V	1500V
可调范围	0V... U_{Nom}	0V... U_{Nom}	0V... U_{Nom}
市电波动范围在 $\pm 10\% \Delta U_{IN}$ 时的稳定度	< 0.02%	< 0.02%	< 0.02%
满载0...100%时的稳定度	< 0.05%	< 0.05%	< 0.05%
满载100%时电压从R10至90%的上升时间	最大30ms	最大30ms	最大30ms
纹波 ***	< 400mVpp < 80mVrms	< 800mVpp < 200mVrms	< 1000mVpp < 350mVrms
精确度 *	$\leq 0.2\%$	$\leq 0.2\%$	$\leq 0.2\%$
显示器分辨率	100mV	1V	1V
远程感测补偿	最大18V	最大20V	最大30V
过压保护门限 (可调)	0...660V	0...1100V	0...1650V
输出 - 电流			
额定电流 I_{Nom}	70A	30A	30A
可调范围	0... I_{Nom}	0... I_{Nom}	0... I_{Nom}
市电波动范围在 $\pm 10\% \Delta U_{IN}$ 时的稳定度	< 0.05%	< 0.05%	< 0.05%
满载0...100% ΔU_{OUT} 时的稳定度	< 0.15%	< 0.15%	< 0.15%
纹波 ***	< 30mApp < 12mA rms	< 22mApp < 11mA rms	< 19mApp < 13mA rms
精确度 *	$\leq 0.2\%$	$\leq 0.2\%$	$\leq 0.2\%$
显示器分辨率	10mA	10mA	10mA
负载从10...90%瞬态恢复时间	< 2ms	< 2ms	< 2ms
输出 - 功率			
额定功率 P_{Nom}	15000W	10000W	15000W
电压<150V $U_{i,n}$ 时的额定功率	0... P_{Nom}	0... P_{Nom}	0... P_{Nom}
精确度 *	$\leq 2\%$	$\leq 2\%$	$\leq 2\%$
显示器分辨率	0.01kW	0.01kW	0.01kW
效率	95.20%	95.50%	95.50%
输出 - 内阻 ****			
最大可调阻值	171.4 Ω	666.7 Ω	1000 Ω
精确度 *	< 2%	< 2%	< 2%
显示器分辨率	100m Ω	100m Ω	1 Ω
设定值至实际值的调整时间	~ 2s	~ 2s	~ 2s
其它			
环境温度	0...50° C	0...50° C	0...50° C
储存温度	-20...70° C	-20...70° C	-20...70° C
相对湿度	< 80%	< 80%	< 80%
尺寸 (WxHxD)**	19" 3U 595mm	19" 3U 595mm	19" 3U 595mm
重量	33kg	25.5kg	33kg
冗余操作	无	无	无
+输出对外壳的耐压	1000V DC	1500V DC	2000V DC
-输出对外壳的耐压		300V DC	
绝缘耐压输入对输出		2500V DC	
制冷	风扇制冷, 前板为入风口, 后板为排风口		
安全标准	EN 60950		
EMC标准	EN 61326, EN 55022 等级 A		
过压等级	2		
保护等级	1		
污染程度	2		
工作高度	<2000m		
串联操作	可行 (但有限制)		
主-从操作	无		
并联操作	可行, 经共享总线实现电流均衡分布		
主-从操作	无		
模拟编程	经内置隔离模拟接口或插拔式模拟接口卡		
绝缘电压	内置接口: 1500V IF-A1接口卡: 2000V		
输入范围	0...5V 或 0...10V, 可选		
精确度*	$\leq 0.2\%$		
输入阻抗	53k Ω		
数字编程	经可插拔式接口卡: RS232, USB, CAN, GPIB, Ethernet		
产品编号	09901444	09901438	09901439

* 与额定值有关, 该精确度决定设定值与实际值间允许最大误差。

举例: 一台80V型号产品的电压精确度最少为0.2%, 即为160mV。当设定5V电压时, 且允许最大误差为160mV, 故得出实际值可能在4.84V和5.16V之间。

** 此仅为外壳尺寸, 非产品整体外形尺寸。

*** MPP值: HF 0...20MHz, RMS值: LF 0...300kHz

**** 可解锁选项功能

3. 产品描述

3.1 各面视图

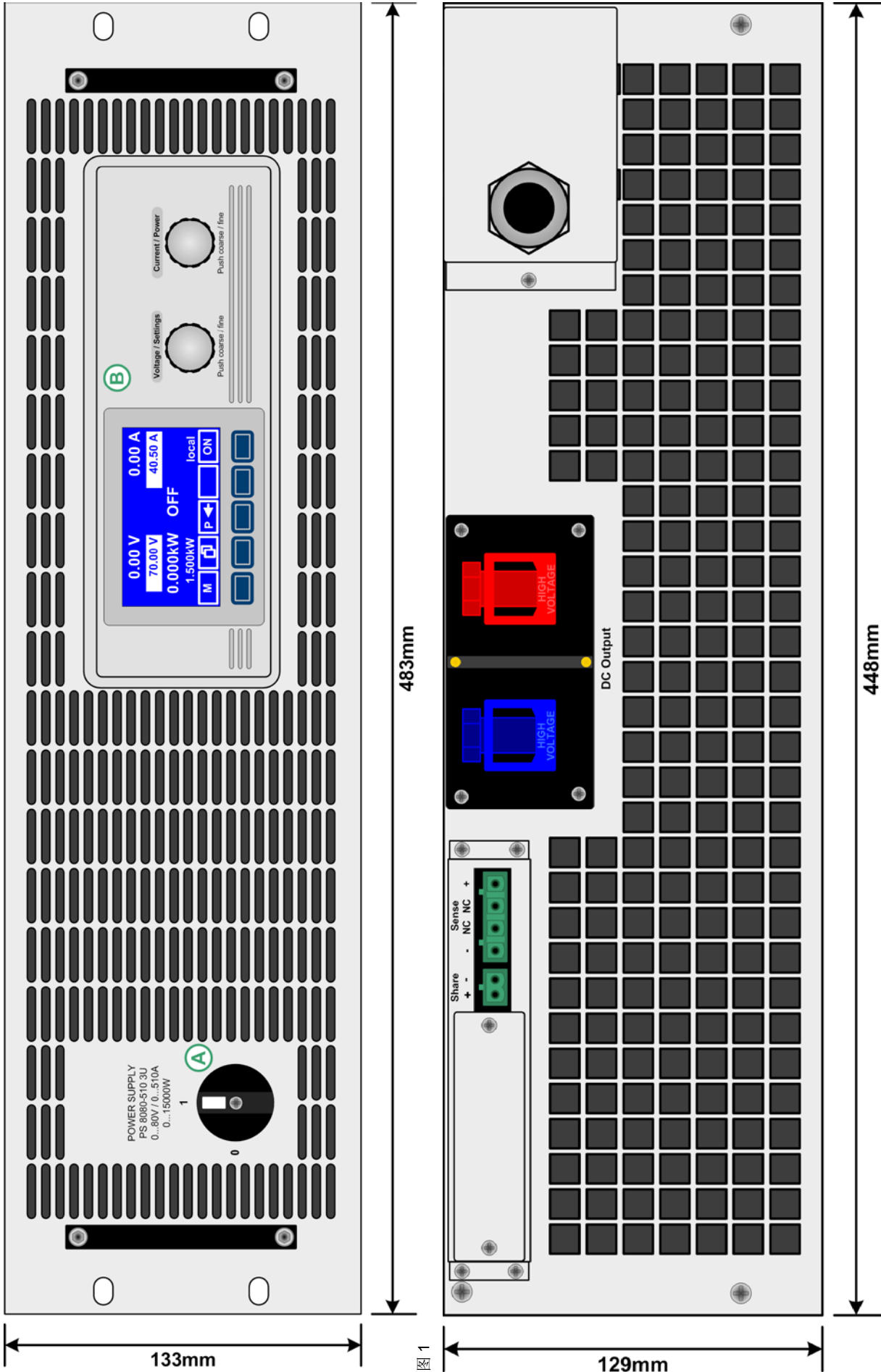

D - 共享总线和远程感测端
 E - 直流输出端
 F - 交流输入端

A - 电源开关
 B - 控制面板
 C - 接口卡插槽





图 3



图 4

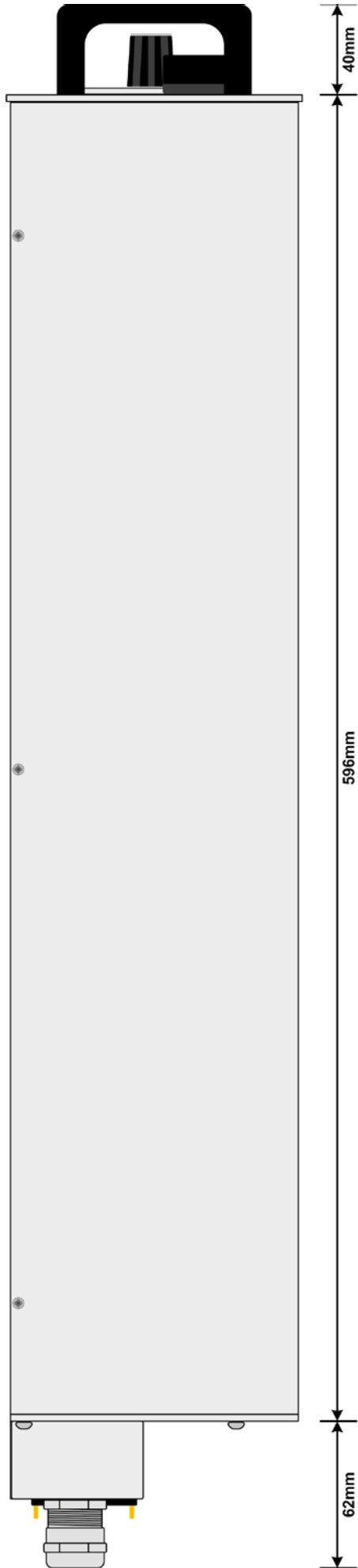

图 5

450mm

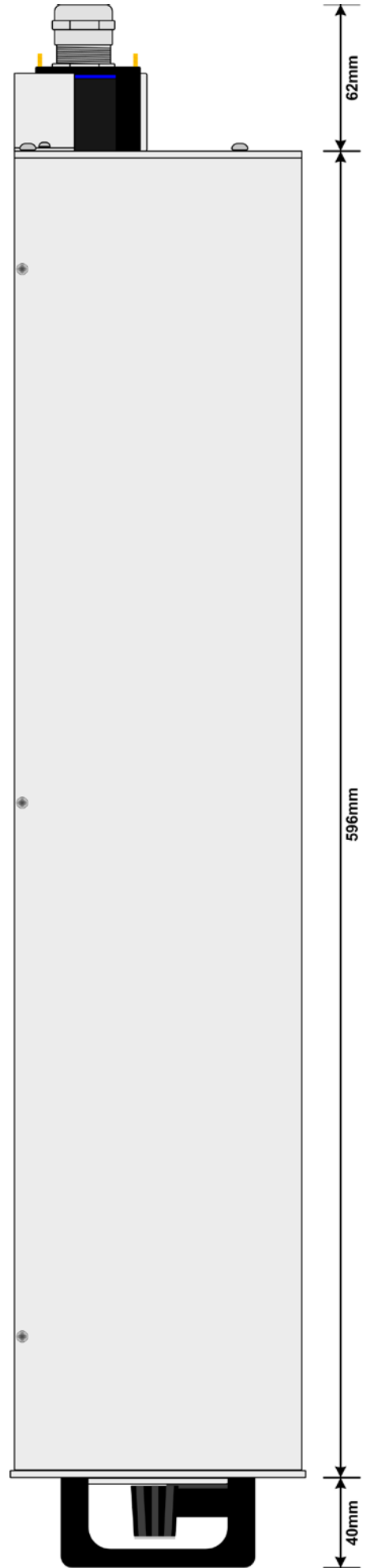
3.2 供应清单

- 1 x 电源供应器
- 1 x 印刷版使用操作指南，并附有一张CD
- 1 x 共享总线插头（已插上）
- 1 x 远程感测用插头（已插上）

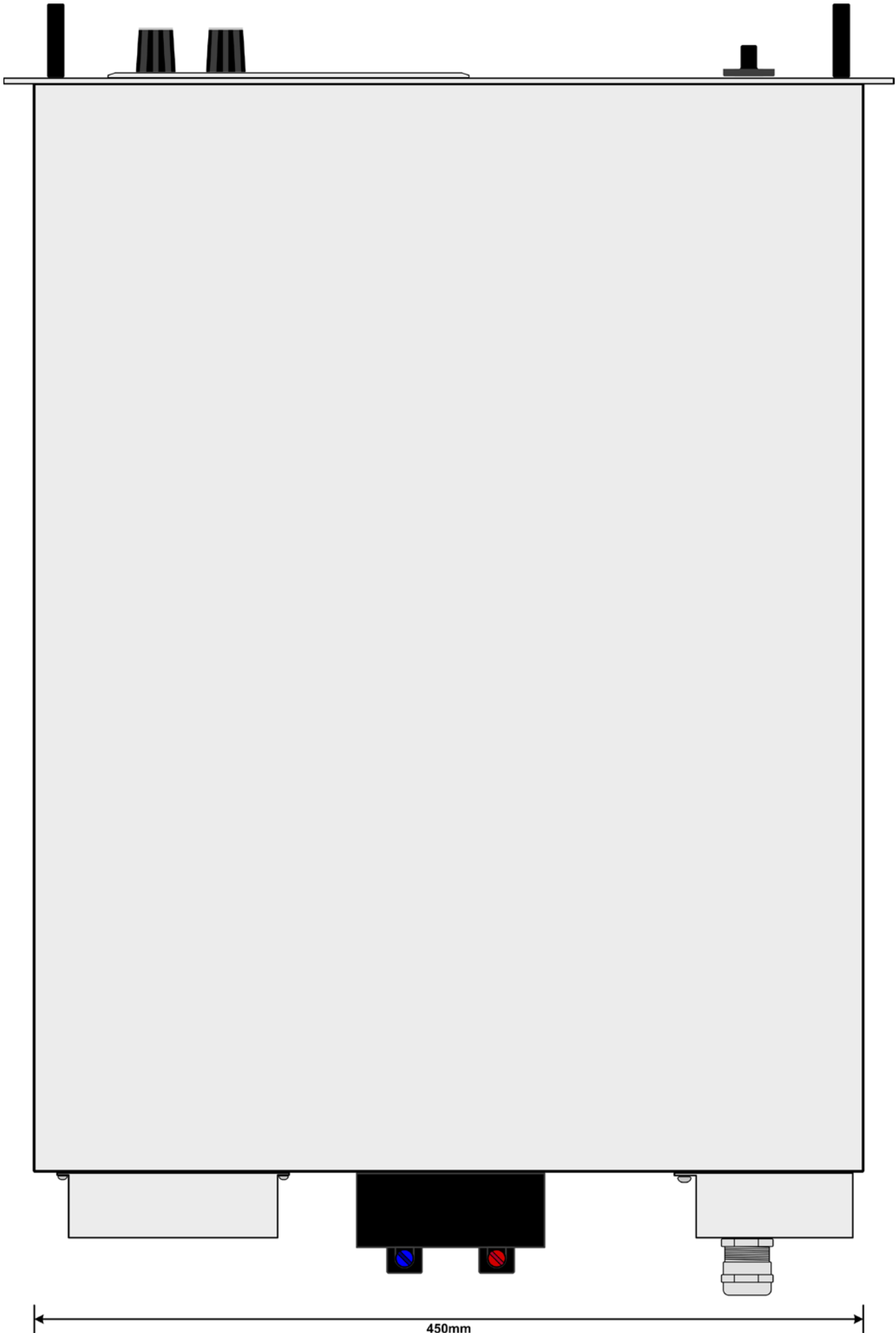
4. 一般信息

4.1 序言/安全警告

本操作指南和本设备专给对本电源有基本了解的人士使用。不应给无基本电器知识的人士操作，因本操作指南未作此方面解释。操作不当和未遵守安全说明的操作可能导致仪器损坏或丧失保修的权利！

4.2 制冷

前板进风孔和后板排风孔必须保持干净，以保证良好的冷却效果。注意产品(后方)要与周围摆放的任何物体保持至少10cm距离，以保证空气通畅。

4.3 打开产品

打开该产品或用工具从内部取出零件时可能有高压触电的危险。必须将该产品与主电源断开后方可进行，否则用户自行承担风险。

只有受过电流危险知识训练的人员方可进行相关维护或修理。

打开产品通常只为更换保险丝。

4.4 冗余操作

本系列部分型号还具有冗余操作功能。意思是，产品上含有两至三个功率段，只要有一个功率段维持工作，其他功率段因过热而被关闭，本电源仍将供电到输出端。

5. 安装

5.1 目检

收到产品拆包装后，请检查是否有外观受损痕迹。如有，请不要操作该产品，应立即联系您的供应商。

5.2 输入端连接（单机）

本系列产品的交流输入端必须连接带接地（PE）的三相供电电压。

该连接必须使用合适直径的连接线来完成。见下表举例，都针对单机连接的连接线：

	L1		L2		L3	
	∅	I _{max}	∅	I _{max}	∅	I _{max}
10kW	4mm ²	28A	4mm ²	16A	4mm ²	16A
15kW	4mm ²	28A	4mm ²	28A	4mm ²	28A

我们建议如下：

对于10kW/15kW型号： 至少为4mm²

针对每相以及地(PE)。

5.3 输入端的连接（多台机）

若有多台同功率或不同功率的产品连接到同一三相电压连接端上，则需考虑相位间电流的分配，以便分配均衡。若连接1台或2台产品，将会引起不平衡的电流分布，3台则是最理想的。

下图以10kW型号产品的配置为例：

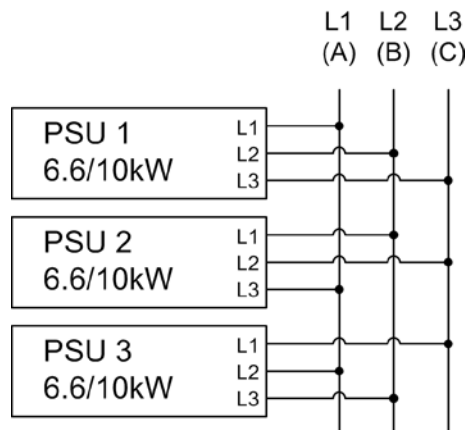

5.4 输入保险丝

本系列产品最多配有6个F16A/500V，6.3x32mm的保险丝熔断保护，都安装在产品内的主滤波板上，该线路板就在前板后面。如需更换保险丝，必须打开产品上盖。

5.5 直流输出端

功率输出端位于产品后方。

该输出端无保险熔断！为避免负载应用损坏，需一直注意负载的额定值。

负载连线的直径由几个条件决定，如输出电流，线长和环境温度。

我们建议使用1.5m长的连线：

- | | |
|-----------------------------|------------------------------|
| 针对30A: 6mm ² | 针对70A: 16mm ² |
| 针对90A: 25mm ² | 针对140A: 50mm ² |
| 针对170A: 70mm ² | 针对210A: 95mm ² |
| 针对340A: 2x70mm ² | 针对510A: 2x120mm ² |

上面每个直流输出端连线的最小直径（软性线）。

例如70mm²的单线，也可用2条35mm²的连线代替。



图 6. 10kW/15kW产品输入端连线图

5.5.1 输出端类型

- 400V以上型号号：
塑胶螺丝夹型端子
建议：使用孔径为6mm的圆形接线片

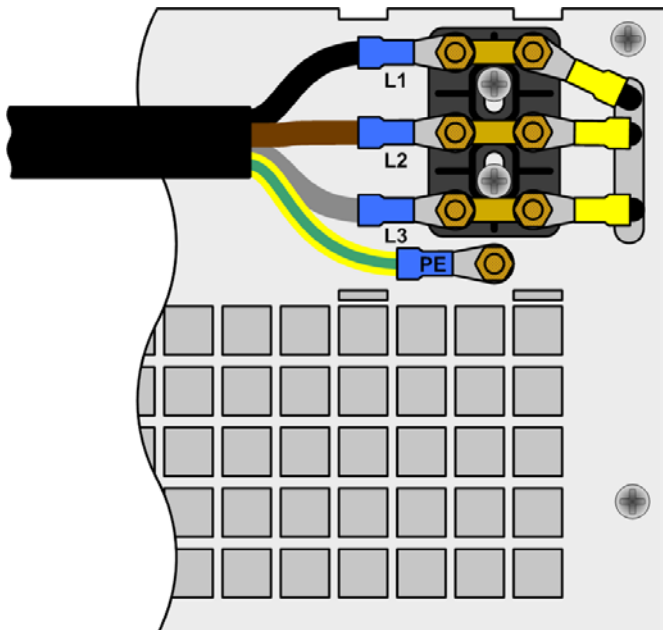
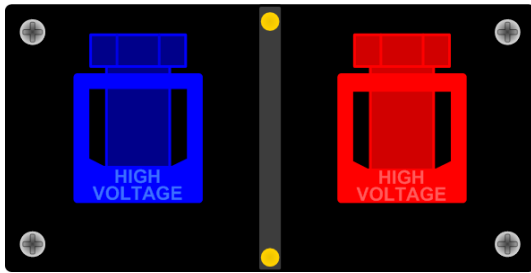

5.6 输出端接地

⚠ 注意!

一般情况下可将单机之间或者并联下多台机的直流负 (-) 输出端接地。额定电压为**300V**以下产品，只有其直流正 (+) 输出端方可接地。

⚠ 注意!

将其中一输出极接地时，请随时检查负载(如电子负载)的其中一极是否也已接地。否则将引起短路!

5.7 “Sense”（远程感测）端

为了补偿负载线上的压降，电源可“感测”负载上的电压，而不是输出端的电压。它将调整输出电压，以便能提供所需电压给负载。最大调整值可见章节,,2.2. 各型号规格参数“下的“远程感测补偿”。

远程感测的连接点在产品后板“感测”端子上。也可见章节3.1。

⚠ 注意!

(+) 感测端只能与负载设备(+)端相连，(-)感测端与(-)端相连! 否则会损坏两头的产品。

面板其它信息请见章节,,8.7. 远程感测被激活“。

5.8 “Share”（共享）端

若想使用共享总线操作，只要将相关产品的“共享”端连在一起即可：

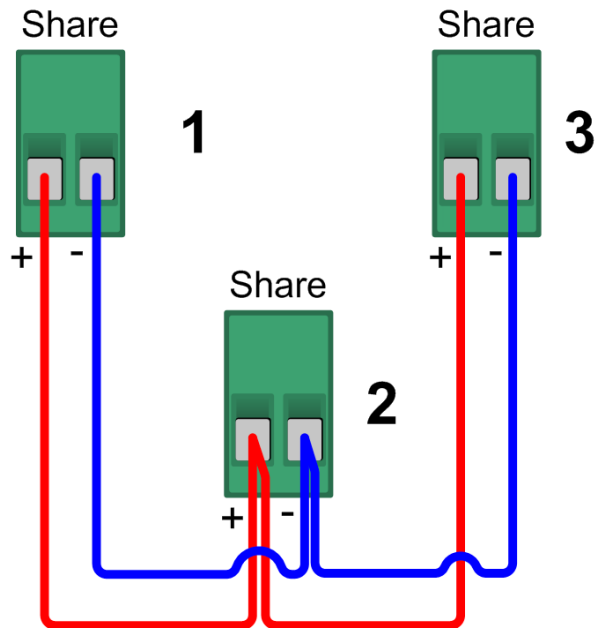

再无其它操作。关于共享总线操作详情请参考章节,,13.1. 共享总线模式下的并联“。

⚠ 注意!

不可将不同于**3U**系列的产品连接到共享总线端上，即使它也有共享总线连接功能

5.9 接口卡插槽

本系列产品可配一接口卡。接口卡插槽位于产品后面。关于卡的详细信息请参考接口卡用户使用指南中章节,,9. 插拔式接口卡“，以及接口卡快速安装指南。

6. 操作

6.1 显示

图8展示了图形显示器的总图。正常操作时，显示器显示实际和设定电压（左上排）和电流（右上排），以及功率（左下排）。而在设置模式下，显示参数和相关设置。

如果“内阻控制”被解锁，内阻设定值可能代替功率设定值，随产品设置所选而定。

6.2 使用符号

下列描述的显示和操作元素以不同符号标示。

 = 仅显示，所有只显示，代表状态的元素以这个符号标识

 = 参数，可更改值以该符号标识，且表示强调

 = 菜单项目，可选择，指向下个分级或带参数的最低级
 {...} 括号表示可能的选项或参数的调节范围。

6.3 各显示元素简介

 **70.00 V** 实际输出电压

 **35.00 A** 实际输出电流

 **1.300kW** 实际输出功率

正常操作期间，实际值以大写字母显示。

 **70.00 V** 设定电压

期望输出电压的目标值（左旋钮）。可对该值粗调（见章节6.6的步宽）或细调（逗号右边的位数）。粗调和细调见得转换通过左旋转编码器上的按钮完成。

 **40.50 A** 设定电流

期望输出电流的目标值（右旋钮）。可对该值粗调（见章节6.6的步宽）或细调（逗号最右边数位）。粗调和细调见得转换通过右旋转编码器上的按钮完成。要调节设定值必须先按  按钮。

 **1.500kW** 设定功率

期望最大输出功率的目标值（右旋钮）。要设定该值，必须在之前就按下  按钮。该数值可粗调（见章节6.6的步宽），也可细调（逗号最右边数位）。

 **10.00 Ω** 设定内阻（选项）

期望内阻的目标值（右旋钮）。如果内阻控制解锁，且在产品设置下选择了U/I/R模式，该设定值替代功率设定值。要设定该值，必须先按下  按钮。

电源输出的状态显示于显示器右下角。

 {ON,OFF} 电源输出状态

当前激活的控制模式显示于相应实际值的右边。这些输出值由激活的控制模式限定：

 **CV** - 由电压设定值限定 (= 恒压)

 **CP** - 由功率设定值限定 (= 恒功率)

 **CC** - 由电流设定值限定 (= 恒电流)

 **CR** - 由设定内阻值限定 (U/I/R模式下)，显示于实际值旁 (= 恒阻)







图 7

另外与输出状态不同的，还有报警、警告或信号提示：

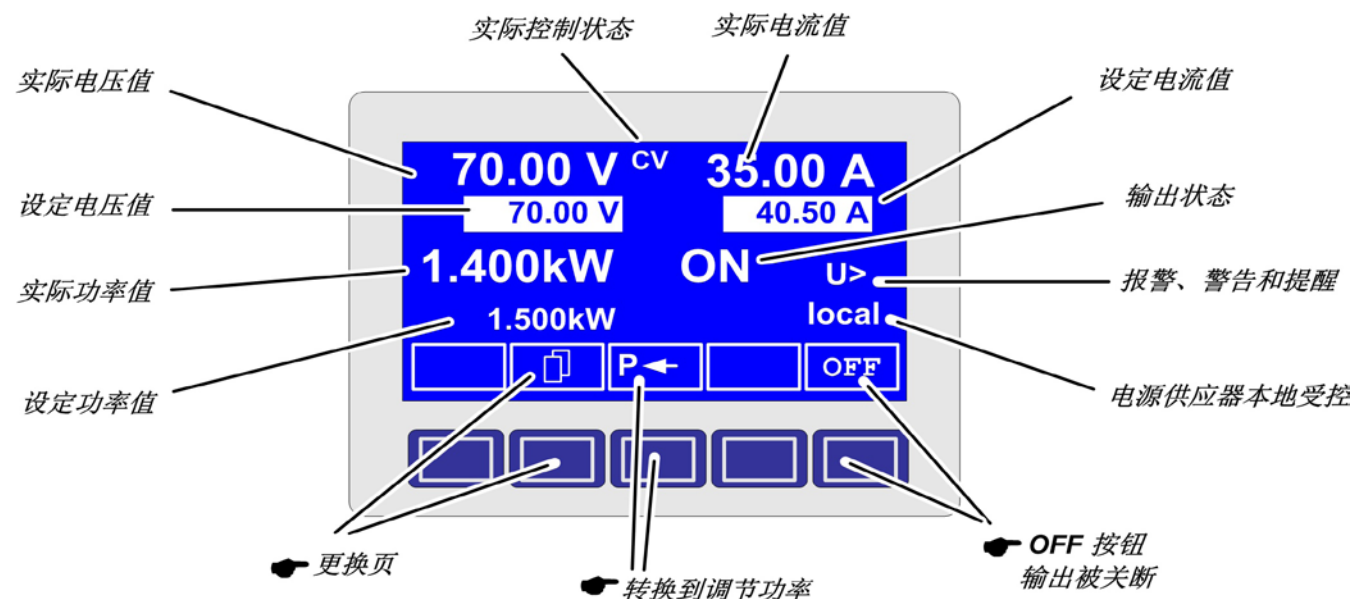
-  **Alarm** 如： = 过温
-  **Warnings** 如： = 过压
-  **Signals** 如： = 过流

产品当前受控位置显示于输出状态下方。此位置是绝对的，它表示用户在不改变控制位置时不能从其它位置控制该仪器。

-  **local** 只能在该仪器上控制
-  **remote** 通过通讯接口（IF-C1, IF-R1, IF-U1 等。）进行远程控制
-  **extern** 通过内置或可选模拟接口的远程控制

6.4 打开产品

产品可用主电源开关打开。开启后，显示器显示出产品型号与用户文本，如已编程进去的话。

可使用随附的LabView VI经其中一数字接口卡输入用户文本。该文本用来辨别多机复杂环境下的单机。

内部系统验证并启动后，电源的最后状态（设定值，报警管理等）被存储下来。可在  **Profile** 菜单下设定电源断电（电源故障错误）或产品再次打开后恢复输出状态。



6.5 打开功率输出

按下  按钮即可打开电源输出，只要它未被内置模拟接口或可选模拟接口卡IF-A1的输入引脚“REM-SB”（13）覆盖，因为该引脚享有更高的优先权。如果试着用该按钮打开输出，显示器会指示“**auto ON**”状态文字，提示用户一旦清除该引脚的阻止信息，即可打开输出。

提示

在**local**状态下（见章节6.9），模拟接口的REM-SB引脚（内部或外部）是无效的。



于是显示屏应该显示“**ON**”输出状态。





 按钮关闭电源输出。显示状态为  **OFF**。

6.6 调节设定值

提示

设定值可以粗调或精调（见下面步宽表）。从粗调到精调或反过来操作需使用显示器旁边的两个旋钮。这些旋钮还有推动功能。最后选定的模式，粗调或精调，在产品关闭后不会被保存。产品通电后，固件C3.13或更高版本默认为粗调模式，否则默认精调模式。

只要  **extern** 或  **remote** 未显示，则可手动调节设定电压、电流或功率值。

在产品设置  **Accept set value** 下选择设定值提交方式。通过按钮  **M** ->  **Profile** ->  **General settings** ->  **Control panel** 进入该设置。详情见„7.4. 配置控制面板“。

直接设置设定值

用旋钮可直接设置设定值。

左旋钮调电压。当电压设定值被选定并调整时，数字反过来显示。

右旋钮既可以设置电流、功率设定值，也可以设置内阻设定值（当选择了模式，且该模式已解锁）。选定的设定值反向显示于屏幕上。

用**SELECT**键可选择：

 **P** 功率设定值

 **R** 内阻设定值或

 **I** 电流设定值

也可限制最大可调功率。

传送设定值

与设定值直接调节方式不同的，还可选择只有当提交设定值后用**RETURN**键方可设定这些参数。详情参考„7.4. 配置控制面板“。设定值仍可用旋钮来更改，但只要没有提交就不会传到输出端。设定值未被修改时，只有单位才反向显示。修改后数值和单位都反向显示。

SELECT键可从电流调节转至功率调节，用右旋钮调节。此时选择的设定值未提交，也未设定。

 按下**RETURN**键就提交设定值。

 **ESC** 按下**ESC**键则取消新设定值，显示旧值。

提示

设定阻值的调节仅可在解锁了“内阻控制”选项（见章节7.9）后才可执行。

提示

可从 0Ω 至 $20 \cdot U_{nom} \div I_{nom}$ 调节设定内阻。意思是，举例：当产品的 $U_{nom} = 1000V$ 和 $I_{nom} = 30A$ ，那我们可就可将它调至最大 666.6Ω 。

使用预设值

在菜单  **Preset List** 下有一个由4组设定值组成的表格（见„7.2. 预定义预设清单“）。用左旋钮选择预设清单，用**RETURN**按钮提交设定值，或用**ESC**按钮放弃使用。

 **1-3** 选定的设定值组目前仍为1。按下**RETURN**按钮后，第3组设定值被提交给店员。显示器则显示新的设定值组，第3组。

 **MEMORY** -按钮可用来直接跳跃到定义预设清单的菜单页，然后利用**RETURN**按钮，按照正常方法进行编辑和提交。

设定值调节步宽

电压			电流		
额定值	粗调	细调	额定值	粗调	细调
600V	5V	0.1V	30A	0.2A	10mA
1000V	10V	1V	70A	0.5A	10mA
1500V	10V	1V			

功率			阻值		
额定值	粗调	细调	额定值	粗调	细调
10kW	0.10kW	0.01kW	171.4/666.7Ω	1Ω	0.1Ω
15kW	0.10kW	0.01kW	1.000kΩ	10Ω	1Ω



提示

可调设定值的分辨率在某些型号上要高于输出电压分辨率。故有可能发生执行2或3个步宽后才能改变输出电压。

6.7 转换按钮面板



PAGE按钮可转换至另一按钮面板。用户利用其他面板的新按钮锁定控制面板，转至函数管理器或设置位置模式。

6.8 锁定控制面板



“锁定按钮面板”按钮可锁住所有除它自身和旋钮外的任何其它键。这样产品被锁定后，不可手动进入，不能更改任何参数，也不可进入任何菜单。在菜单下可设定锁定模式。于是可使控制面板完全失效，或者用**OFF**键解除(产品被锁定但可通过**OFF**键打开和关闭)。可参考章节„7.4. 配置控制面板“的“键盘锁定”。



控制面板锁定后，图标即变为这个。此按钮可用于再次解除控制面板的锁定，如果



按住此键2s。

6.9 控制定位模式



用**EXT**按钮，用户通过数字或模拟接口卡可启动远程控制，停用 local模式。



用此手型按钮可将产品设为有限性的 local模式，从而仅可手动控制它，而且拒绝经任何模拟或数字接口的访问。

6.10 转至函数管理器



SEQ键将显示屏转至函数管理模式。

只有当产品处于待机状态(输出=关闭)时方可转至函数管理器。且当前的电压、电流设定值为0V和0A。详情请参考章节„6.15. 函数管理器“。







显示	错误类型			根据	描述
	报警	警告	简单提示		
OV	·				电源输出端过压
SYS	·				一般系统错误
FCT	·				不能存储和/或不能提交函数
OT	·			1)	过温错误
		·		2)	
CAN		·			CAN总线传输错误
U>	def.	def.	def.		超过过压监控阈值
U<	def.	def.	def.		超过欠压监控阈值
I>	def.	def.	def.		超过过流监控阈值
I<	def.	def.	def.		超过欠流监控阈值
U↗	def.	def.	def.		正向电压转换时设定值比较出错
U↘	def.	def.	def.		负向电压转换时设定值比较出错
I↗	def.	def.	def.		正向电流转换时设定值比较出错
I↘	def.	def.	def.		反向电流转换时设定值比较出错
P↗	def.	def.	def.		正向功率转换时设定值比较出错
P↘	def.	def.	def.		反向功率转换时设定值比较出错

1) OT disappear = OFF

2) OT disappear = auto ON

6.11 激活菜单

M 主菜单通过**MENU**键进入，显示屏转换到主菜单界面，出现如下文本菜单：

	Profile	设置和选择用户档案
	Function	设置函数列
	Analog interface	设置内部模拟接口
	Communication	配置可插拔式接口卡
	Options	默认设置，解锁功能，锁定产品配置
	About...	生产商，服务，软件版等

ESC 按**ESC**按钮将进入上一级菜单页。



  按**SELECT**键选择进入另一个菜单。

 按**RETURN**键进入下一级子菜单。菜单最后一级总以参数页显示，详见下一个主题。

6.12 参数页

参数页为菜单最底级。在这您可更改多种不同参数来设置产品。

ESC 按**ESC**键进入参数页的上级菜单，不再接受任何参数。

  用**SELECT**键选择不同参数。所选参数会反向显示，用左旋钮可进行更改。

 **RETURN**键将更改后并被接受和保存的参数提交出去。并退出参数页面，进入下一个上级菜单。

6.13 报警、警告和信号提示

报警，警告和简单提示（此被称作“信号提示”）以声音或可视信号发出。内置模拟接口或可选模拟接口卡IF-A1的“OT”或“OVP”引脚也报告过压或过温错误。也可见章节„7.4. 配置控制面板“。

报警要优先于警告或信号提示。一次可显示多至四种报警，警告或信号提示，且以每两秒间隔时间循环一次。如显示的信号超过四个，再有报警出现，前面的警告或提示信号将被取消，用报警替代。

输出电压、输出电流，及真实值与设定值间的差异都能监控到。

下页的表列出了可能出现的错误种类和其代表意义，产品可配置的可选错误种类。

报警 会关断输出，必须确认后才可重新启动输出（见第„6.14. 报警和警告的确认“）。

警告 如未被确认则一直显示于屏幕。如果“auto ON”由于某一特殊故障被激活，则暂时关断电源输出。例如：在系统链接模式下从属电源的输入电压瞬间缺失。

提示信号 仅显示，并持续至故障原因消失。如出现超过一个以上的提示信号，它们将以2s的间隔时间循环显示。

6.14 报警和警告的确认

 **QUIT**键确认报警和警告。

用此键确认了出现的警告后，将转为信号并持续显示，不然被删除，不再显示。

函数管理器显示全图：



图 8

6.15 函数管理器

 提示

只要PV功能被激活，函数管理器则不可用（见章节14.3）！

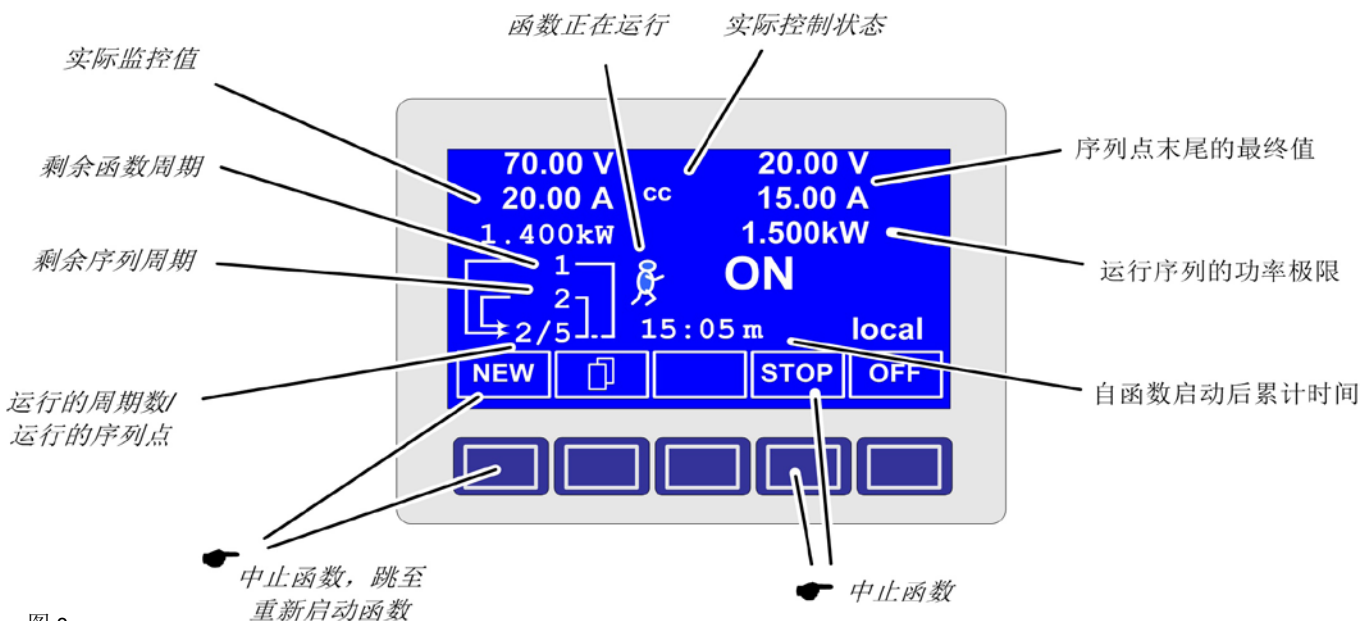
函数管理器用于创建可自动控制产品的函数。函数 $f(U, I, \Delta t)$ 创建后，用户可建立设定值曲线。函数管理器每隔2ms设置设定值，意指只有2ms的倍数时间才能设定，比如：50ms。如果两点间的电压或电流改变，将形成一个由一定步骤组成的跳跃。（ $\Delta t: 2ms$ ，形成25个步骤，如果设定值是50ms的话）

函数管理器控制电源，输入配置在函数内的设定值。输出值的实际发展由负载决定。

使用术语解释：

Function-函数=由多达5组连接的序列头(在菜单  Setup function开始)构成，而一个函数可组成多达五组不同的配置序列。

Function layout-函数排布=通过函数管理器在函数布局下的配置，可设定电源操作模式(U//P 或 U//R)。而且还可在此处设定函数的重复率和序列的任意秩序。根据函数布局，函数管理器在上个序列完成后处理下一列，并使用下列的序列控制设定值。

Sequence-序列=由序列控制和10个序列点构成。如果函数管理器即将处理一序列，首先设定序列控制给出的参数，连续设定10个序列点，按照某特定序列设定的重复率，重复整个处理程序。

Sequence control-序列控制( Sequence control) = 定义序列重复率和序列处理过程中最大功率设定值与内阻(选项，必须解锁)。







Sequence point-序列点=一个序列通常由10个序列点组成。序列点由函数管理器从0点到9点连续处理。序列点的定义决定了要在给出时间 Δt 内达到设定的电压、电流值。这使得用户通过设定0ms或2ms的阶跃函数和4ms至99h99m时间坡度，创建阶跃函数。还可设定0ms的时间，但形成的真实时间会是2ms，因为设定值是以2ms为一阶跃阶段。

除函数外，您可设置和使用用户化设置内的监控电路。也可通过接口卡的链接控制函数管理器，其特点：您可在函数将要停止的地方设置一暂停点。

6.15.1 配置函数



菜单页  Function 指向下列菜单选项：

-  Setup function
-  Sequence 1
-  Sequence 2
-  Sequence 3
-  Sequence 4
-  Sequence 5

6.15.2 函数布局



此处可定义电源的操作模式和函数的重复率。

◆ Function mode

- = U//P 函数使用U//P运作模式
- = U//R 函数使用U//R运作模式
(仅当“内阻”选项解锁后)

也可见章节,7.1. 定义操作参数 “。

◆ Funct.cycles

- = {1..254} 循环n次
- = ∞ 无限制循环

◆ Link sequences to one function

- Task: 1 2 3 4 5
Seq.: {-,1..5} {-,1..5} {-,1..5} {-,1..5} {-,1..5}





用户可针对特定任务定义函数由哪一序列组成，以何种顺序排列。图标“-”表示该任务未被定义，因此将不被处理。

6.15.3 配置序列

菜单页  Sequence {1..5} 指向序列编辑页。



指向下列菜单选项：

-  Sequence {1..5} (要编辑的序列数)
-  Sequence control
-  Sequence points 0-4
-  Sequence points 5-9

此处可设置序列重复率，最大功率和内阻(可选，要解锁)，以及序列点。

6.15.4 与序列有关的参数



显示电源供应器的函数模式。

- ◆ Seq. cycles {1..254, ∞} 默认: 1
- = {1..254} 重复n次
- = ∞ 重复无数次

- ◆ P seq= {0...P_{nom}} 默认: P_{nom}

此处的最大功率影响整个序列。

仅在选择“内阻”项的情况下(可解锁)：

- ◆ R seq= {0Ω...20 * R_{inom}} 默认: R_{inom}

此处的最大内阻影响整个序列。

6.15.5 定义序列点



一个序列由10个序列点组成。一个序列点由3组数据组成：电压U，电流I和时间 Δt 的设定值。

- ◆ $\Delta t = \{0 \dots 99:59h\}$

- ◆ $U [V] = \{0 \dots U_{nom}\}$

- ◆ $I [V] = \{0 \dots I_{nom}\}$

要了解序列如何处理，您需考虑每个序列周期的开始条件：

函数开始的设定值

函数通常这样开始

$U_{set} = 0V$ 和 $I_{set} = 0A$

再次进入序列的设定值

如果序列重复，最后被处理的序列将改变下个序列循环的开始条件。

比如：将序列点9设为80V/50A/250ms，重复运行该序列，于是序列以80V/50A，和之前设为0序列点（如：500ms）的时间开始循环。在500ms这个时间段内，设定值将以线性地接近0序列点的定义值。

6.15.6 函数运行时的显示



也可见上页全图。

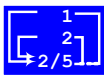

 **70.00 V**
35.00 A
1400kW 实际值的显示

在显示器左边，实际值以小字体显示。运行的控制状态(CV/CC/CP)显示在对应值的右边。

 **20.00 V**
15.00 A
1500kW 序列处理完后即将到达的序列点设定值，显示于屏幕右边。

  显示函数运作的状态，函数(1)和序列(2)的剩余重复次数，当前序列号(2/_)和现时运行的序列点(_/5)。

  表示函数管理器暂停或尚未开始。

  函数管理器正在运行。

 **15:05 m** 函数发生器启动后的累计时间也会显示出来。函数管理器停止，时间显示才停止。**STEP**、**RUN**或**GO**键以多种方式操作函数管理器，同时时间显示会持续累计。

 **{ON,OFF}** 电源输出状态

除电源输出状态外，还显示报警，警告或信号提示状态。

6.15.7 函数管理器的控制

交互式控制面板给函数管理器提供多个控制键。利用这些按键用户可暂停、继续、重设为起始点或退出函数管理器。

函数管理器真正设定电源前，可在显示屏幕上模拟此函数。在此操作过程中

- 不可打开输出，且

- 一步一步处理这些序列点，并按相同方法检验。

也可通过接口卡执行此操作。还可在50个序列点中额外地设置一停顿点。处理到这个点时，序列、函数就会暂停。

 **ESC**键退出函数管理，并返回电源的前一状态。

 **STEP**键逐步运行序列。按下此按钮，执行当前序列点。完成这个后，显示于屏幕右上角的设定值被设定。

 **RUN**键启动函数管理器，按定义值运行函数，然后持续处理序列点。

比如：待机时的模拟显示如下：

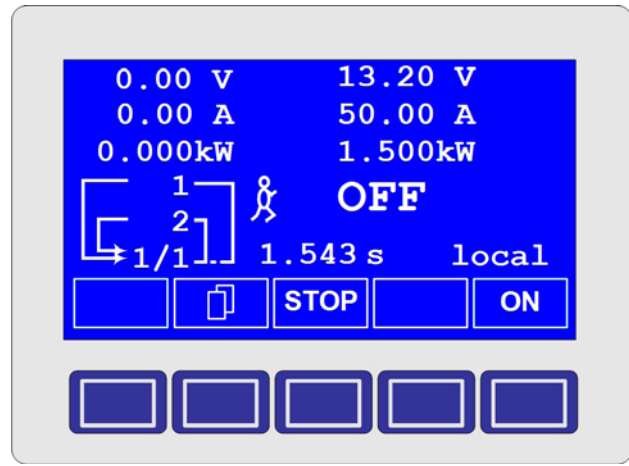

 **GO**用**GO**键继续运行停止后的函数。

 或者用**NEW**键可重设函数管理器，开始执行当前函数。

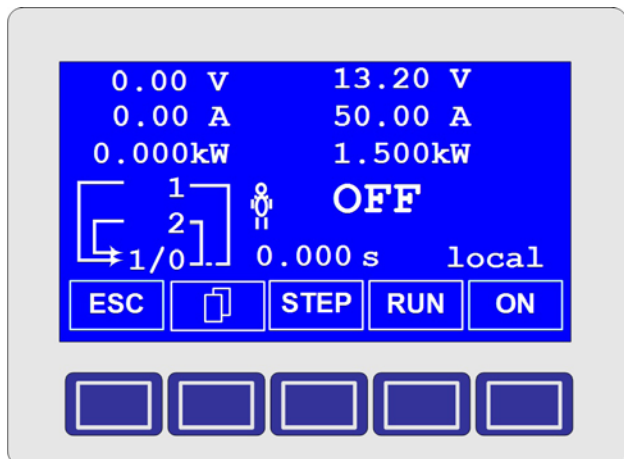
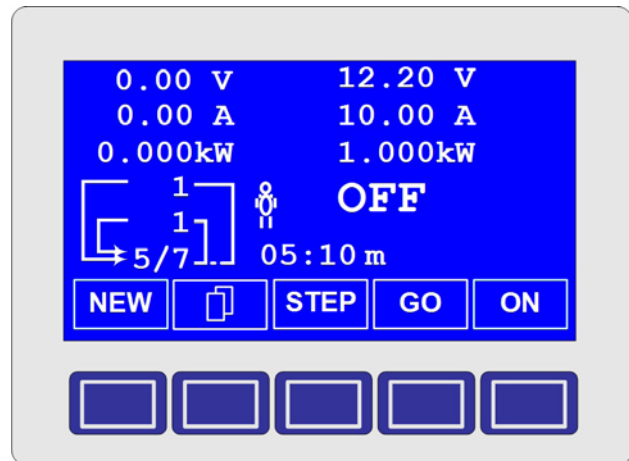

7. 产品设置

第1部分: Profile菜单

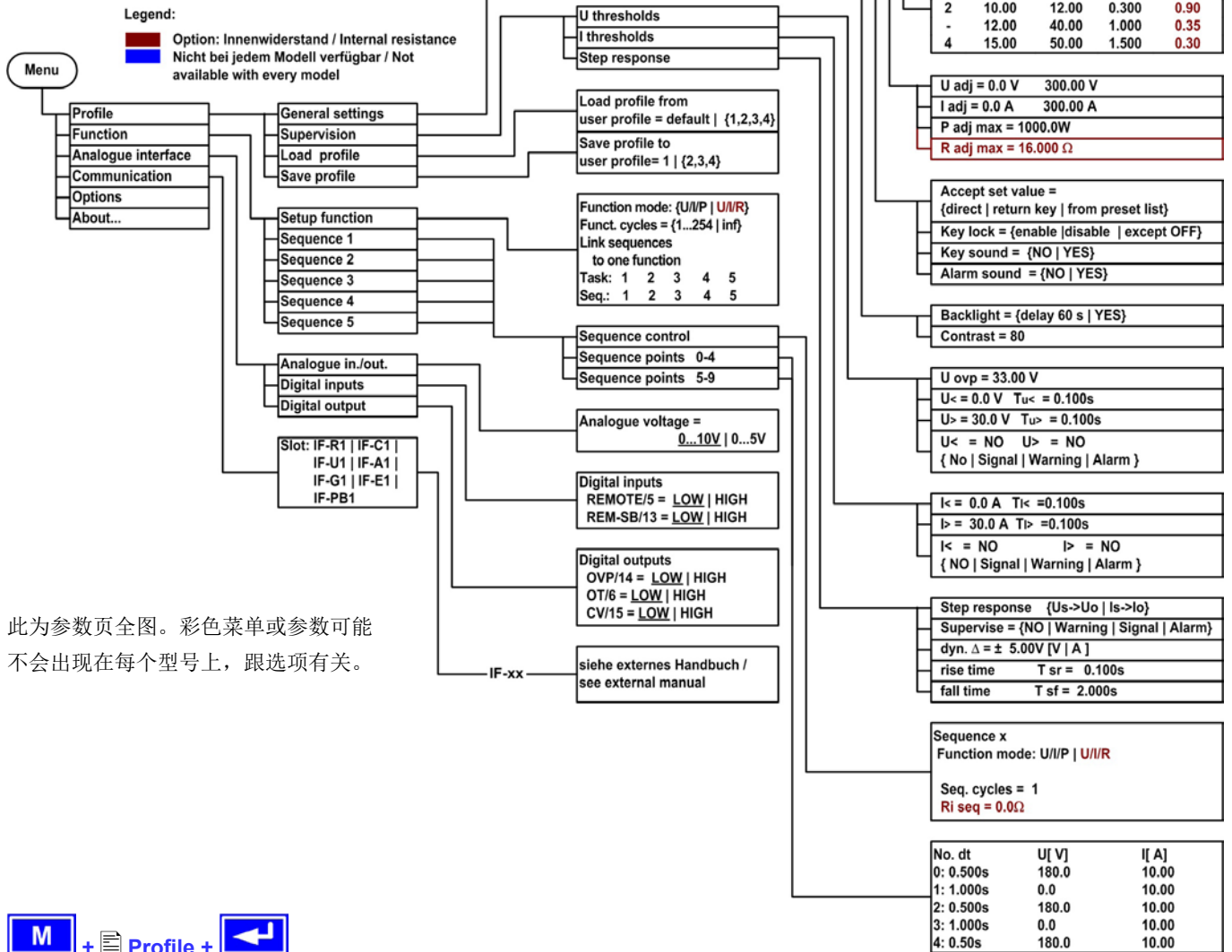

此为参数页全图。彩色菜单或参数可能不会出现在每个型号上，跟选项有关。

M + Profile + [Left Arrow]

该配置文件意在减少不同用户设置产品时所需时间，或保留用户定义的设定参数，以便将来重复使用。最后使用的配置文件总在电源启动后加载。

进入 Profile 菜单将出现下列选项：

- General settings
- Supervision
- Load profile
- Save profile

General settings + [Left Arrow]

进入 General settings 菜单，指向下列选项，可配置操作模式，显示界面，产品处理（调节）：

- Setup operation mode
- Preset list
- Adjust limits
- Control panel
- Display

Supervision + [Left Arrow]

进入 Supervision 菜单，指向下列选项，可对报警、警告和信号提示，还有相应监控限制和反应时间进行设置。

- U thresholds
- I thresholds
- Step response

Load profile + [Left Arrow]

◆ Load profile from user profile = {1..4, default}

当前配置文件被所选配置文件表代替。

Save profile + [Left Arrow]

◆ Save profile to user profile = {1..4}

当前配置文件被存储于四个配置文件中的其中一个。

7.1 定义操作参数

Setup operation mode +

在此可设置操作模式即将使用的设定值调节方式，主电源供电恢复后产品如何反应的设置，或产品出现过温异常后的行为。

U/I/P 或 U/I/R 操作模式

◆ Setup op. mode 默认：U/I/P

= U/I/P 功率级由设定电压、电流和功率控制。

= U/I/R 功率级由电压、电流和内阻设定值，以及可设不可调的功率设定值（仅当“内阻控制”选项解锁后）控制。U/I/R操作模式只有在  Options 菜单中解锁后方可使用。解锁码可从供货公司买到。当购买产品时应要求告知序列号，因为解锁码与此相关。

过温错误出现后的恢复

◆ Output on OT 默认：auto ON

= OFF 即使电源已经冷却，电源输出仍为关闭状态。

错误  OT (过温) 以报警形式显示。

= auto ON 当电源冷却到过温关闭极限以下，会自动打

开。错误  OT (过温) 以警告形式显示。

= ON 只要至少有一个功率级在工作，电源输出就保持打开状态，并一直提供电压。

警告与报警一样，只有当此动作被确认后才会从显示屏消失（见章节 „6.13. 报警、警告和信号提示“）。

“电源打开”后的输出状态

◆ Power ON 默认：OFF

= OFF 市电恢复或电源被打开后其输出仍关闭。

= restore 电源供应器输出恢复到市电断电或电源供应器被关闭之前的状态。如果关闭产品时电源状态为ON，再次启动后，输出仍为ON。

7.2 预定义预设清单

Preset List +

可预先定义4组不同预设值。

No.	U[V]	I[A]	P[kW]	R[Ω]*
1:	0.00	0.00	1.500	200
2:	10.00	10.00	1.200	250
-:	0.00	0.00	1.500	500
-:	0.00	0.00	1.500	800

* 阻值(红色)仅在U/I/R模式解锁的情况下出现。根据产品型号的不同，阻值会在Ω和kΩ之间变化。

利用参数 ◆ Accept set value = from preset list 您可从正常设定值转换到其中一组预设值，或在两组预设值之间转换。通过此选项实际上可在设定值之间“跳跃”。

7.3 调节极限

! 提示

所有下面描述的极限值仅影响正常设定值，而非那些可在函数管理器下为序列编辑的设定值！

Adjust limits +

在此可定义最大和最小调整极限。这些极限常常在本地或远程模式（即：产品由电脑控制）下受干扰。

电压设定极限值

◆ U adj 默认：0V, U_{nenn}

= {U_{adj.min}} {U_{adj.max}}

反之 U_{adj.min} = {0...U_{adj.max}} und U_{adj.max} = {U_{adj.min}...U_{nenn}}

在此可定义可调电压的上限和下限。超出极限的设定值不被接受，不管是由控制板还是由电脑远程控制（通过接口卡通讯）产生。

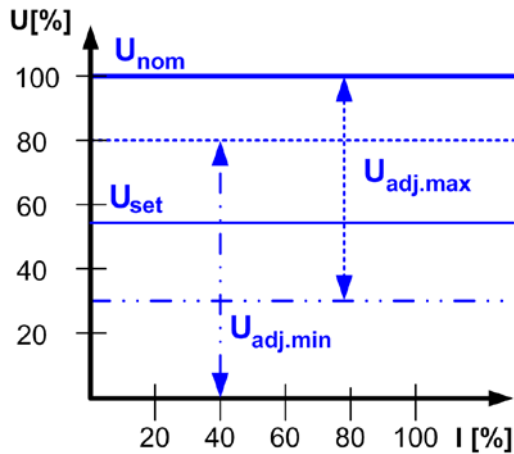

设定电流极限值

◆ **I adj** 默认: 0A, I_{nenn}
= { $I_{adj.min}$ } { $I_{adj.max}$ }

反之 $I_{adj.min} = \{0 \dots I_{adj.max}\}$ und $I_{adj.max} = \{I_{adj.min} \dots I_{nenn}\}$

在此可定义可调电流的上限和下限。超出极限的设定值不被接受, 不管是由控制板还是由电脑远程控制(通过接口卡通讯)产生。

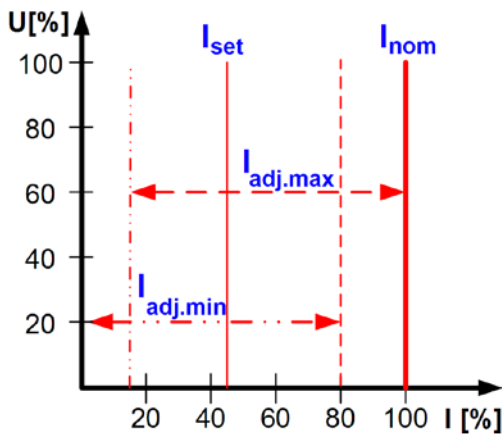

设定功率极限值

◆ **P adj max** 默认: P_{nenn}
= { 0 kW... P_{nenn} }

在此可定义可调功率的上限和下限。超出极限的设定值不被接受, 不管是由控制板还是由电脑远程控制(通过接口卡通讯)产生。

设定内阻极限值

(可选项, 仅在U/I/R模式解锁情况下)

◆ **R adj max** 默认: 0Ω
= { $0\Omega \dots 20 * R_{inenn}$ }

如果U/I/R模式已解锁, 您可定义可调内阻的上限和下限。超出极限的设定值不被接受, 不管是由控制板还是由电脑远程控制(通过用接口卡通讯)产生。

7.4 配置控制面板

☰ **Control panel +**

菜单页 ☰ **Control panel** 能让您设置所有与图显和控制面板有关的参数。

配置设定值的调节方法

- ◆ **Accept set value** 默认: **direct**
 - = **direct** 用旋钮更改设定值后, 直接递交到产品功率级。
 - = **return key** 仅当用 键提交后方可设定更改后的设定值。
 - = **from preset list** 用旋转编译器从 ☰ **Preset List**选择设定, 然后用 按钮提交。

控制面板的锁定

仅能在此配置控制面板的锁定。

- ◆ **Key lock** 默认: **except OFF**
 - = **except OFF** 控制面板(按键和旋钮)将被锁定, 但是 **OFF**键除外。
 - = **enable** 旋钮和多数按钮将被锁定。
 - = **disable** 打开

控制面板的锁定是为了避免对设定值或其它设置进行不需要的更改。

! 提示

该设定仅为临时性设定。产品重新打开或者断电后重获市电, 该设定会重置 (=disable)。

信号音

- ◆ **Key sound** 默认: **NO**
 - = **YES** 按键有短“嘀”音提示
 - = **NO** 按键无声响
- ◆ **Alarm sound** 默认: **YES**
 - = **YES** 如出现报警或警告, 每间隔一短暂时间即发出“嘀”音信号。
 - = **NO** 报警/警告不带声音信号

7.5 配置图显

Display + 

菜单页  **Display** 设置所有与图显相关的参数。

◆ **Backlight** 默认: YES

- = YES 背光灯常亮
- = delay 60s 最后一次使用按键或旋钮, 60s后背光灯关闭。

◆ **Contrast** 默认: 70



- = { 40...100 }

可按产品安装位置和能更清晰地观看数值来调节对比度。

7.6 监控

Supervision + 

菜单页 **Supervision** 配置对输出电压、电流和功率的监控, 也可对阶跃函数监控。  **Supervision** 菜单页指向下列选项:

-  **U thresholds**
-  **I thresholds**
-  **Step response**

7.6.1 电压的监控

 **U thresholds+** 

菜单页  **U thresholds** 设置过压极限 (OVP), 以及过压与欠压的监控电路。



过压保护 (OVP)

◆ **U ovp** 默认: $1,1 \cdot U_{Nenn}$

- = { $U > \dots 1,1 \cdot U_{Nenn}$ }

过压保护意在保护连接负载。应将过压保护阈值调至负载能承受且不受损的最大电压值。如果超过该极限值, 会即刻关断输出。

举例: 一台80V产品的 U_{ovp} 最大能调到88V。

  **OV** 这个是以报警显示的过压保护。(见章节,6.13. 报警、警告和信号提示 “)

过压监控

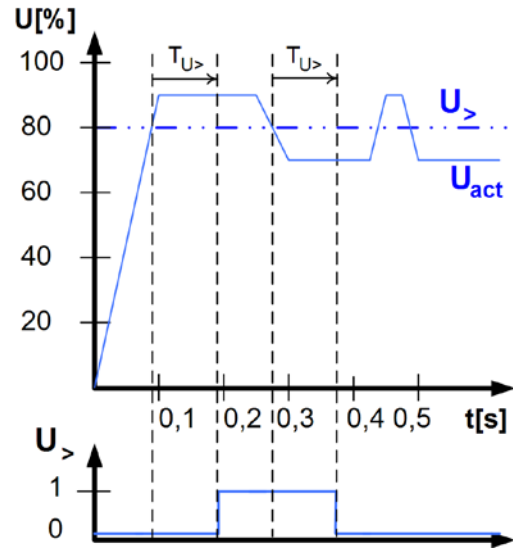
◆ **U>** 默认: U_{Nenn}

- = { $U < \dots U_{ovp}$ }



◆ **Tu>** 默认: 100 ms

- = { 0...99:59h }

这与OVP(见上述)有稍微不同。这个也可监控电压, 但过了定义的延时 ◆ **Tu>** 时间后, 以报警, 警告或信号提示告知用户。

如果在 ◆ **Tu>** 时间内电压下降至极限以下, 该信号消失。因此您不是每次收到OVP错误信息, 或者过压出现时间大于定义

◆ **Tu>** 时间时只听到报警声, 也可监控过压。

  **U>** 报警: 过压

此错误关断电源输出。必须确认报警错误后, 才能再次打开输出。

  **U>** 警告: 过压

此错误出现后并持续存在, 直到信息被确认方才消失。

 **U>** 信号提示: 过压

欠压监控

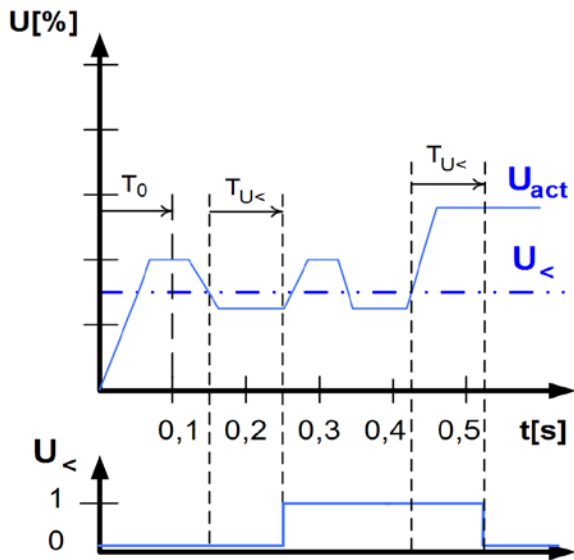

- ◆ $U_{<}$ 默认: 0V
= {0... U>}
- ◆ $T_{u_{<}}$ 默认: 100ms
= {0...99:59h}

电压一下降至欠压极限以下，过了响应时间◆ $T_{u_{<}}$ 后，发出欠压信号。如果在◆ $T_{u_{<}}$ 内超过欠压极限，信号消失。在电源输出打开后，欠压错误仅维持 $T_0=100ms$ 。

- $U_{<}$ 报警：欠压
此错误关断电源输出。必须确认报警信息后，才能再次打开输出。
- $U_{<}$ 警告：欠压
此错误出现后并持续存在，直到信息被确认后方才消失。
- $U_{<}$ 信号提示：欠压

模拟接口(IF-A1,可选)可从其中一数字输出端发出过压或欠压信号。

7.6.2 电流的监控

I thresholds +

菜单页 I thresholds配置欠流和过流监控电路。

欠流监控

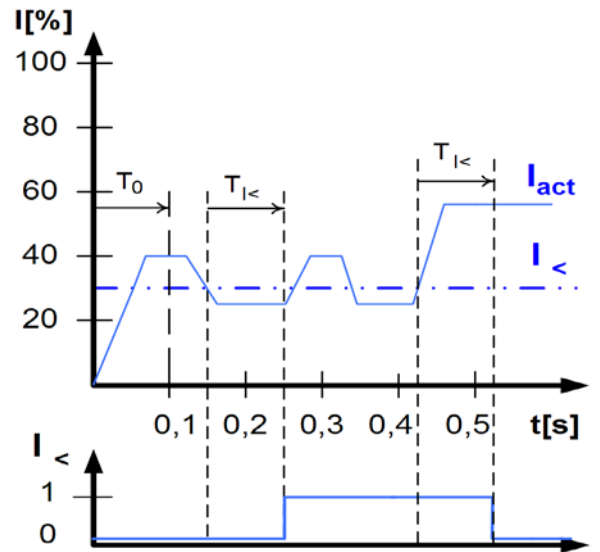

- ◆ $I_{<}$ 默认: 0A
= {0... I>}
- ◆ $T_{i_{<}}$ 默认: 100ms
= {0...99:59h}

如果电流实际值降至已调欠流极限以下，过了响应时间◆ $T_{i_{<}}$ 后，发出欠流错误信号。如果在◆ $T_{i_{<}}$ 内实际电流超出极限，错误提示消失。再电源输出打开，欠压错误仅维持 $T_0=100ms$ 。

- $I_{<}$ 报警：欠流
此错误关断电源输出。确认报警信息后，才能再次打开电源输出。
- $I_{<}$ 警告：欠流
此错误出现后并持续存在，直到信息被确认后方才消失。
- $I_{<}$ 信号提示：欠流

过流监控

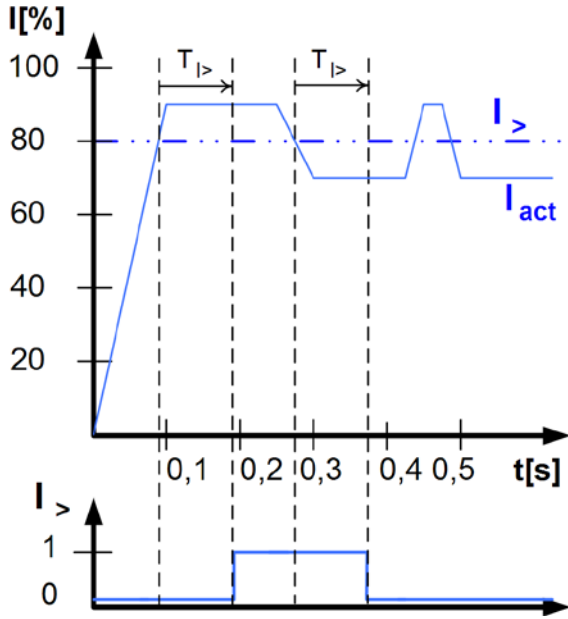

◆ $I >$ 默认: I_{Nenn}
 = { $I < \dots I_{Nenn}$ }

◆ $T_{i>}$ 默认: 100ms
 = { 0...99:59h }

如果实际电流已降至调节的过流极限以下，过响应时间◆ $T_{i>}$ 后，发出过流错误信号。如果实际电流在◆ $T_{i>}$ 内超出此极限值，错误提示消失。再电源输出打开后，过压错误仅维持 $T_o=100ms$ 。

报警: 过流

此错误关断电源输出。必须确认报警信息后，才能再次打开电源输出。

警告: 过流

此错误出现后并持续，直到信息被确认后消失。

信号提示: 过流

模拟接口(IF-A1,可选)可从其中一数字输出端发出过流或欠流信号。

7.6.3 阶跃响应监控

Step response +

菜单项 Step response配置实际值与设定值的动态和静态比较监控电路。

◆ Step response: 默认: $U_s \rightarrow U_o$

$U_s \rightarrow U_o$ 监控设定电压和实际电压的偏差
 $I_s \rightarrow I_o$ 监控设定电流和实际电流的偏差

◆ Supervise 默认: NO

NO 监控启动
 Signal 监控报告一信号
 Warning 监控报告一警告
 Alarm 监控报告一报警

◆ dyn. Δ 默认: 10% I_{nom} resp. U_{nom}
 = $\pm \{0 \dots 1,1 * U_{nom}\}$ 电压允许误差
 = $\pm \{0 \dots I_{nom}\}$ 电流允许误差

提示

电源供应器的设置过程取决于负载。当一组设定值被更改后，要过一定时间才能将期望值传到电源输出端。比如：在无负载或带很小负载的情况下，要花几秒钟的时间电压才从100%降到0V，因为输出电容需要一定的时间放电。

阶跃响应的监控

已调设定值与真实测量值进行比较。如果它们之间有差异，且差异大于误差值，过了设定时间◆ T_{sr} 后，监控器将发出错误信号。见下面数据：

◆ rise time

$T_{sr} = \{0 \dots 99:59h\}$ 默认: 100ms

◆ fall time

$T_{sf} = \{0 \dots 99:59h\}$ 默认: 2s

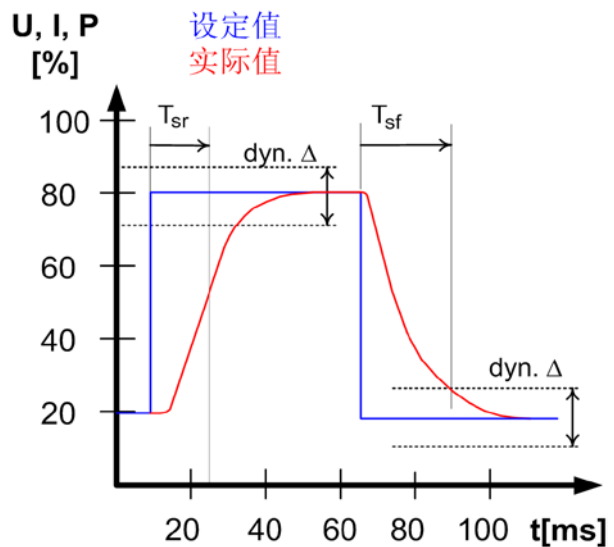

设定/真实值比较的通知

例如：如果在设定时间◆ Tsr内未完成较低设定值到较高设定值的跳跃，就会发出报警、警告或信号提示类的监控错误。



根据 Step response 的配置，会选择性地显示 电流状态。

例如：如果在设定时间◆ Tsf内未完成较低设定值到较高设定值的跳跃，就会发出报警、警告或信号提示类的监控错误。



根据 Step response 的配置，会选择性地显示 电流状态。

第2部分：菜单 Options

菜单



引领你进入下列选项：

Reset configuration

Enable PV mode

Enable R mode

Setup lock

7.7 恢复至默认配置

您可将所有设定的修改恢复到默认状态(产品出厂时的状态)。

进入选择相应菜单后，会再次提示您，是否选择恢复您当前的个人设置。

注意！

即使产品配置用PIN码锁定，也会被该设置解锁和覆盖！



◆ Are you sure ? 默认：NO

= YES 恢复所有默认设置的修改

= NO 不更改

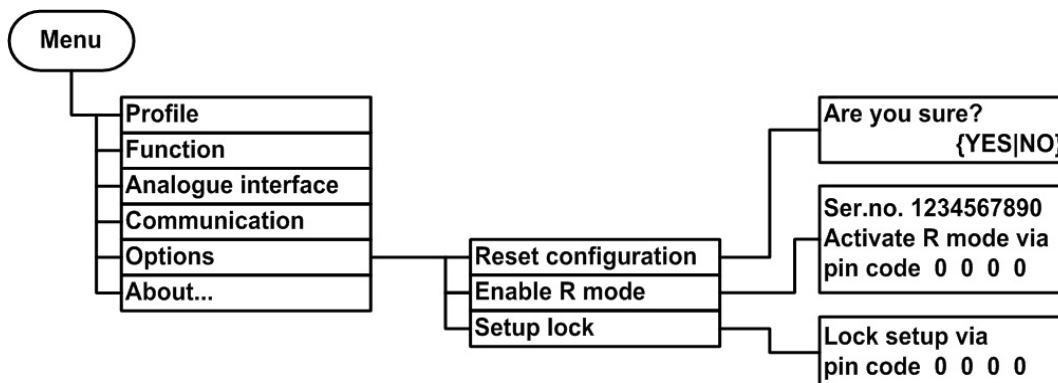

7.8 激活光伏功能



◆ PV mode = {enabled | disabled}

使用enabled设置，光伏特性的硬件和软件功能都被启动。该设置在未更改前都长期有用。激活的功能在主显示器上以PV文本指示出来，位于设定功率值左边。关于PV功能模拟太阳能电池板的原则，请参考章节„11. PV - 太阳能电池板的模拟“。

提示

激活U/I/R操作模式，会自动重设PV mode为disabled。只要U/I/R被激活，PV特性就不会启动。可参考章节„7.1. 定义操作参数“。

7.9 解锁U/I/R运行模式

在 Options 下只有用PIN码解锁U/I/R运行模式后才可用。(见„14.3. 选项：内阻“)。



◆ Activate R mode via pin code:

此处用到的识别码不是免费的，需从供应商购买。解锁后，在

Options 菜单下验证状态：

R mode available:

YES U/I/R操作模式锁定已解除且可用

NO U/I/R操作模式不可用

并在配置文件中也可配置该模式。(见„7.1. 定义操作参数“)。
于是设定内阻从0Ω调节到由 $20 * U_{Nom} \div I_{Nom}$ 计算而来的 R_{Nom} 。

7.10 锁定产品配置



为安全起见，必须锁定产品配置。在此处输入一个由0至15之间的4个数字组成的PIN码。

◆ **Lock setup via** 输入PIN码
pin code: {0..15} {0..15} {0..15} {0..15}

只能用相同PIN码或用



只能用相同PIN码才能解锁，或者用 **Reset configuration** 重新配置。但是它也将删除特制设置，所以忘记PIN码的情况下可使用该方法。

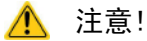

注意!

它仅影响产品的用户化配置，非产品设定值或前板上的旋钮!

8. 特殊特征

8.1 用电源开关打开

电源开关位于产品前端。打开电源开关后，显示器即显示这些信息：生产商名称，地址与商标，产品型号与固件版本。在设置模式下（见„7. 产品设置“）有一“Power On”选项，它决定产品打开后的输出状态。默认状态下为“OFF”，意思是，U、I、P的设定值和输出状态不会恢复为产品上次关闭时的状态。如果选项设为“OFF”，每次打开产品，U和I的设定值为0，P的设定值为100%，输出也被打开。选项设为“restore”时，产品开启后设定值和输出状态即刻恢复。

8.2 用电源开关关闭

用电源开关关闭产品如电源断电一样。它会保存最后设定值和输出条件。短时间过后，功率输出和风扇关闭，几秒钟后，产品完全关闭。

8.3 转至远程控制模式

a) **内置模拟接口**: 如果产品没被**local**模式限制，或早已启动数字接口的**remote**-远程模式，通过设定值引脚VSEL（引脚1），CSEL（引脚2）和PSEL（引脚8），以及状态输入脚（引脚13），引脚5“Remote”可将产品转为远程控制。并立即设置引脚1，2，8和13（也可参考章节„10. 内置模拟接口“）的输出状态和设定值。退回远程控制模式后，将关闭输出，并保留最后远程调整的U、I和P设定值。

b) **可选模拟接口IF-A1**: 如果产品没被**local**模式限制，或早已启动数字接口的远程模式，“SEL-enable”引脚22通过VSEL（引脚3），CSEL（引脚2）和PSEL（引脚1），以及REM-SB（引脚23）的设定值，将产品转为远程控制。输入1，2，3和23引脚（也可参考章节„10. 内置模拟接口“）的设定值和输出条件即刻被设置。从远程控制退出，将关闭输出，并保留最后远程调整的U、I和P设定值。



提示

在产品设置菜单下有一些关于可选模拟接口的设定参数。关于数字引脚的逻辑级别等，在另外的接口卡操作指南中有详细描述。10.4 章节下描述的范例也可用于25针模拟接口IF-A1，但是引脚号和引脚名称会有不同。

c) **可选数字接口**: 如果产品没被**local**模式限制或早已启动数字接口的远程模式，可通过相关指令（此时为：对象）将它转到远程控制，并保留输出状态和设定值，直至被更改。

8.4 过压报警

过压错误可以因内部缺陷（输出电压上升且不可控）或外部电压太高而引起。过压保护(OVP)将关闭输出，并在显示器上以“OV”状态文本信息，内置模拟接口的“OVP”引脚14，模拟接口IF-A1（如果配有的话）的“OVP”引脚8，以及报警符号指示此错误。

应避免加载于输出端的外部电压超过额定电压的120%，否则产品内部元件会受损!

如果过压原因消除，输出会再次打开，“OV”状态文本信息消

失。在此之前，需用 按钮或经数字接口的一个指令确认该报警信号。如果错误仍然存在，则不打开输出。

OVP错误以报警声记录于内部警报缓冲区。通过数字接口可读取该缓冲区内容。用另一指令可清楚缓冲区内容。

8.5 过温报警

一旦因一个或多个功率级内部过热而出现过温(OT)错误，显示器上会出现“OT”文本、警告标识，内置模拟接口的引脚6“OT”，以及模拟接口的引脚9“OT”（如果配有的话）也发出一状态信号。但输出并未总是被关断，根据设定（见„7.1. 定义操作参数“）不同可能继续输出电压。只有当内部所有功率级（10kW型号 = 2级，15kW 型号 = 3级）因过热而切断时输出电压才会为零。

OT错误要用 按钮或经可选数字接口发出相应指令进行确认。OT错误以报警声记录于内部警报缓冲区。通过数字接口可读取该缓冲区内容。用另一指令可清楚缓冲区内容。

8.6 调整电压、电流和功率

电源输出电压和负载内阻决定输出电流。只要输出电流因电流设定值低于调整后设定电流值，产品以恒压(CV)模式操作。且以“CV”状态文本指示出来。

输出电流被设定电流或额定电流限制，产品转为恒流(CC)模式，且以“CC”状态文本指示出来。

本系列所有型号还有一特征，即 $0...P_{Nenn}$ 的可调功率限制。假如实际电流和电压超过了调节功率极限，该功能被激活，且覆盖恒压或恒流调整模式。功率限制最初影响输出电压。因为电压、电流和功率限制是相互影响的，并有可能出现下列情形：

例1: 产品处于恒压调整模式时，功率被限定在范围内。故输出电压被降低。较低的输出电压导致输出电流减小。如果负载内阻减小，输出电流会再次上升，输出电压降至更低。

例2: 产品处于恒流调整模式时，输出电压由负载阻值决定。功率被限定在下限范围内。根据 $P = U \cdot I$ 公式，输出电压和电流被降低至一定数值。一旦电流设定值减小，输出电流也会减小，接着输出电压也一样。产品两数值，实际功率都会在之前设定的功率极限之下。产品将从恒功率调整（CP）切换到恒流调整（CC）。

CC，CV 和 CP相这三个状态也可通过可选模拟接口卡的几个合适引脚指示出来，借可选数字接口卡还可读取状态位元。

8.7 远程感测被激活

程感测操作用来补偿电源和负载间连线的压降。因这受限于一水平，建议按照输出电流选择适当直径的连线，以将压降减到最小。

感测输入端位于产品后板**Sense**端子上，可按正确极性连线到此。电源会自动检测外部感应端，并通过负载的实际电压而非输出电压来补偿输出电压，从而按照电源与负载间的压降值提升输出电压。

最大补偿电压：见规格参数表，不同型号会有不同。

也可见下页图9。

8.8 市电出现欠压或过压

本产品需用到一400V相线电压的三相电源，其电压误差最大为 $\pm 15\%$ 。从而形成340V...460V输入电压范围。在该范围内，产品操作无功率限制。340V AC以下的输入电压被视为欠压，将保存最后状态，并关闭输出。如电压超过460V AC，结果一样。



注意！

应避免输入端长期欠压或过压！

8.9 连接不同类型的负载

不同类型的负载，如阻性负载（台灯，电阻），电子负载或感性负载（马达），性能不同，它们会对电源起反作用。例如，马达会产生一反电压，导致电源因过压保护而关断输出。

电子负载有电压、电流和功率调整线路，它们与电源的相互作用，可能会提高输出纹波或其它多余的副作用。电阻负载几乎100%中性。故建议在安排应用时要考虑负载的特性。



图 9. 感测端连线图

9. 插拔式接口卡

9.1 一般信息

本电源支持多款可选数字或模拟远程控制用接口卡。所有卡都被电隔离。其隔离耐压值如下：

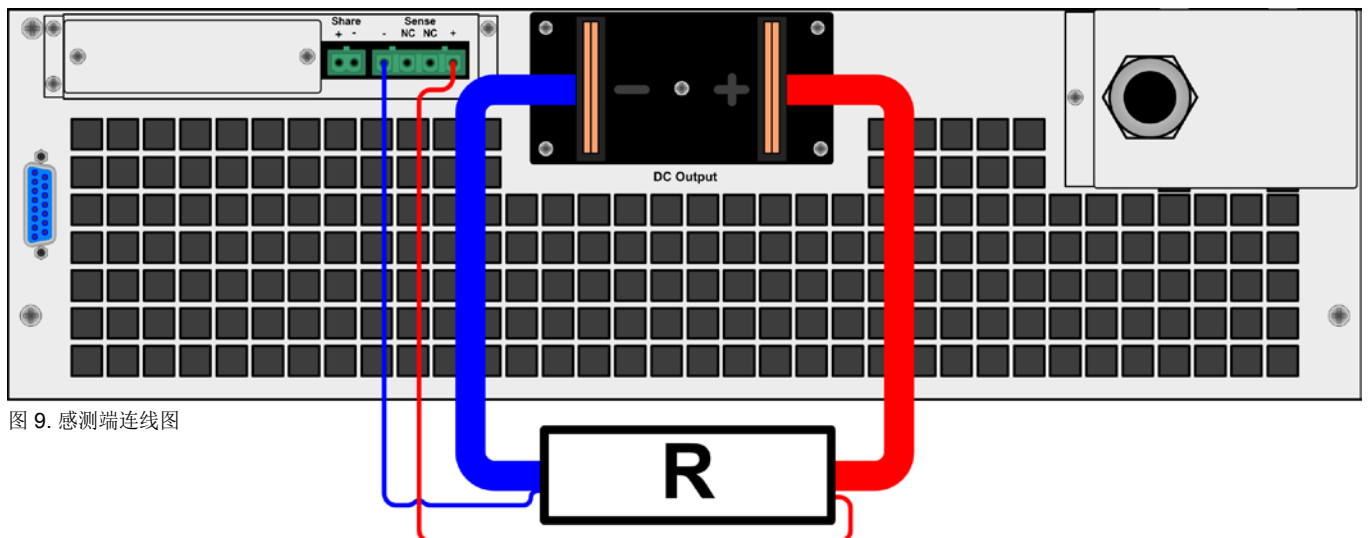
- USB (IF-U1), CAN (IF-C1), RS232 (IF-R1): 2000V DC
- GPIB (IF-G1): 2000V DC
- Ethernet (IF-E1b): 1500V DC
- 扩展型模拟接口 (IF-A1): 2000V DC

提示

在选择接口进行远程控制前，先检查下隔离耐压，并看此特定隔离电压值是否足够于目标应用的需求！

数字接口卡IF-R1 (RS232), IF-C1(CAN) 和 IF-U1(USB) 使用统一的通讯协议。一旦配上这些卡，一台电脑可一次性控制多达30台电源供应器。

GPIB数字接口卡IF-G1 (IEEE 488)为每条总线上的多达15台产品提供一个SCP指令结构。

以太网/LAN卡 IF-E1也提供SCPI指令集，以及浏览界面。它还特别配有一额外的USB端口，能够藉由IF-U1卡访问产品。

接口卡IF-A1为扩展型模拟接口，其特点是隔离耐压值比内置模拟接口更高，以及输入电压范围可变等。更多信息，可参考接口卡操作指南，按照用户需求可将其存储于CD上，随接口卡一起给客户，也可从我公司网站上获取。

9.2 配置接口卡

接口卡装上后，产品会自动识别。同时将接口卡得产品代码，产品编号显示出来。通过

 +  **Communication** +  菜单可进入接口卡的设定。

除模拟接口卡IF-A1与Ethernet-以太网卡IF-E1B外，使用其它接口卡时建议设置产品地址只有这样，当多台产品连接到电脑上时，它们才能被正确识别。选择接口使用

 **Slot A: { IF-... }** 取决于产品所配接口卡型号

◆ **Device node** 默认: 1

= {1..30} 总共可给一台产品配置30个设备结点(地址)。如果是控制多台产品，也只需设置一次设备结点。

配置不同的接口卡

因为不同的卡有不同的配置参数，这些在接口卡用户手册中有相应的详细描述，请参考那些说明。

10. 内置模拟接口

10.1 一般信息

内置、电隔离（具体隔离电压请参考„2. 技术规格“）15芯模拟接口卡插在产品后板，具有下列功能：

- 远程控制输出电流、电压和功率
- 远程监控(OT, OVP, CC, CV)状态
- 远程监控实际值
- 远程打开/关闭输出

设定值输入脚可在0...5V或0...10V电压范围下操作。在产品设置菜单下选择合适的电压范围（见章节10.3）。

使用说明：

- 用模拟电压来控制产品需用“REMOTE” (5)引脚转为远程控制模式。
- 连接控制电源的应用设备前，要保证所有线连接正确，并检查应用设备不会输入高于指定电压的电压（最大12V）。
- REM-SB (远程待机, 13引脚) 引脚要优先于ON按钮。意思是，如果该引脚定义输出状态为“off”。故它可当紧急断电开关用。但不适用于控制位置设为local的情况。详情页可参考章节6.9。
- 当选择了0...5V电压范围，输入10V以下的设定值时，那么高于5V的电压会被忽略（剪切掉），并使输出值保持在100%范围内。
- 如果用户已将产品转至U/I/R模式，且其内阻控制处于被解锁状态，则远程控制不可行。内阻设定值不能通过模拟接口来控制！
- 整个接口对产品直流输出端都电隔离绝缘。

10.2 D-Sub插座图释

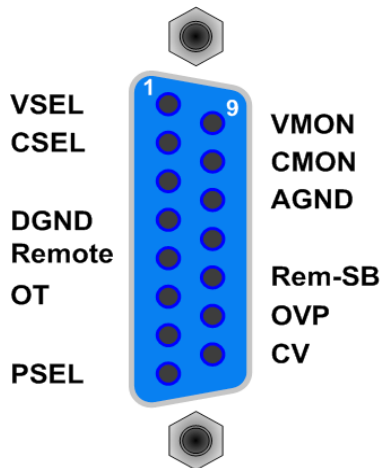

10.3 内部接口卡的设定



设置菜单允许对内置模拟接口设定参数的访问：

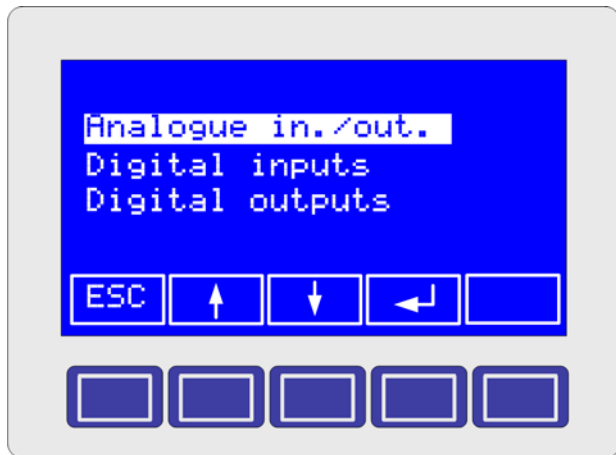

◆ **Analog voltage** 默认： 0...10V
 = 0...10V 对应0...100%的设定/实际值定选择0...10V电压。
 = 0...5V 对应0...100%的设定/实际值定选择0...5V电压。
 为模拟输入和输出VREF引脚的参考电压被自动调节到上述所选电压范围，要么为5V，要么为10V。

◆ **REMOTE /5** 默认： LOW
 = LOW 如果该引脚拉至LOW（地），则产品转换到模拟远程控制。
 = HIGH 如果该引脚拉至HIGH或者悬空，则产品转换到模拟远程控制。

注意！
 该引脚默认连到HIGH电平。意思是，如果引脚设为HIGH，该引脚悬空，产品将永久处于模拟远程控制，除非local模式被激活。

◆ **REM-SB /13** 默认： LOW
 = LOW 如果该引脚拉至LOW（地），则关闭直流输出
 = HIGH 如果该引脚拉至HIGH，则再次打开直流输出

注意！
 该引脚默认连到HIGH电平。意思是，如果引脚设为HIGH，该引脚悬空，产品的直流输出将永久关闭，除非local模式被激活。

◆ **OVP /14** 默认： LOW
 ◆ **OT /6** 默认： LOW
 ◆ **CV /6** 默认： LOW
 = { LOW | HIGH } 定义数字输出脚是否通过LOW或HIGH电平报告他们的指定状态。

10.4 应用举例

注意！
 切勿将模拟接口的地接到产品的负或正输出端！因为这会消除产品的电隔离特征，并有可能给模拟接口，甚至控制设备（如：PLC）带来危险电压，特别是给非隔离逆变器提供直流电时。



图 10

提示
 PLC或任何其它控制设备的数字输出脚也许无法将如REMOTE或REM-SB这样的输入引脚拉至LOW。请参考具体硬件的技术规格。
 REM-SB和REMOTE输入脚的原理图如下图：

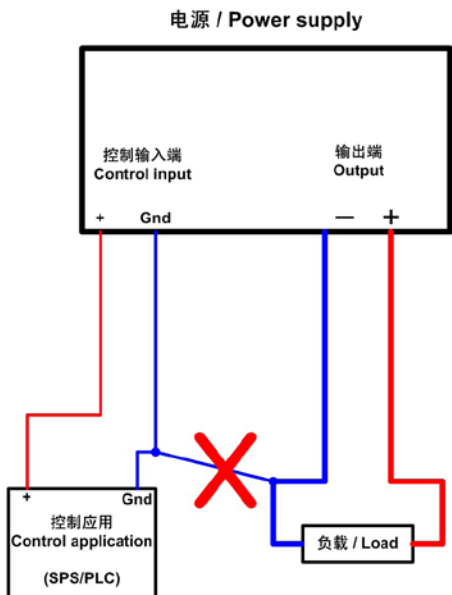
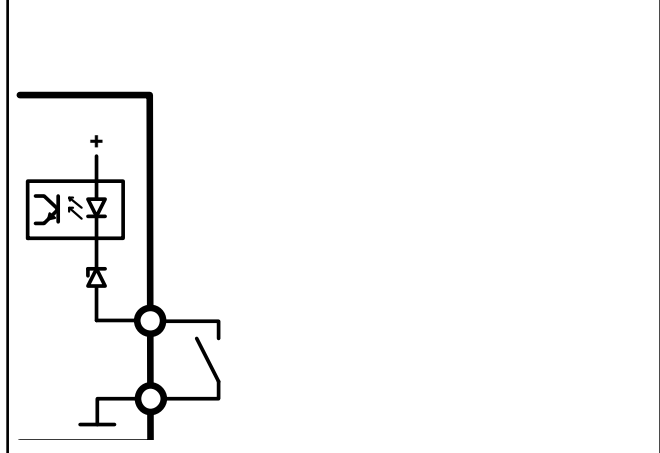

输出关/开

13引脚„REM-SB“的总是处于操作状态，它不取决于产品是否处于远程控制模式。因此在不利用外部手段条件下用它可关闭输出，除非产品被设为local模式，于是该引脚将失去作用。利用低阻接触器，如果引脚REM-SB（见章节10.3）被选为„LOW“设定，通过如开关，集电极三极管或继电器将它接到地（GND）可关闭输出。如果选为HIGH，则相反，接触器要打开，从而关闭输出（对于紧急状况）。

提示

PLC的数字输出脚可能没法正确工作，因为其阻值可能不够低。故请总是先检查下您外控设备的技术规格。

连线举例：

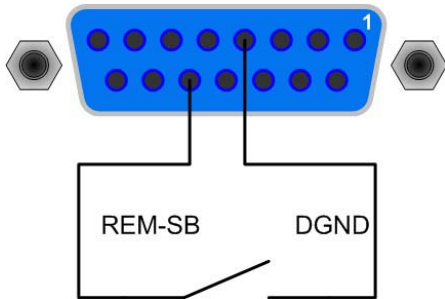

激活远程控制

当要求用外部设定值控制产品时，需将产品转换到远程控制模式。

只要赋予REMOTE引脚相应的级别，即可激活远程控制，且不会被local模式中断。

远程控制激活：REMOTE = LOW | HIGH

远程控制停用：REMOTE = HIGH | LOW

本系列转为远程控制的级别取决于菜单设置下REMOTE引脚的LOW或HIGH设定。

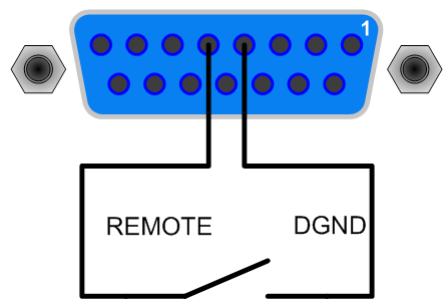

注意!

该引脚默认连到HIGH电平。意思是，如果引脚设为HIGH，该引脚悬空，产品的直流输出将永久关闭，除非local模式被激活。

注意!

在直流输出为打开状态下将产品转换到模拟远程控制，输出电压可能会立即上升至危险水平，这取决于模拟接口的已知设定值!

设定值的远程控制

输入引脚VSEL (电压-U)，CSEL (电流-I) 和PSEL (功率-P, 可调) 的参数必须从外部模拟接口设定。直流输出端0...100%的输出值需通过这些引脚上0...5V或0...10V的输入电压设定。

提示

经模拟接口的远程控制总是要求设定所有三个设定值。

连线举例：

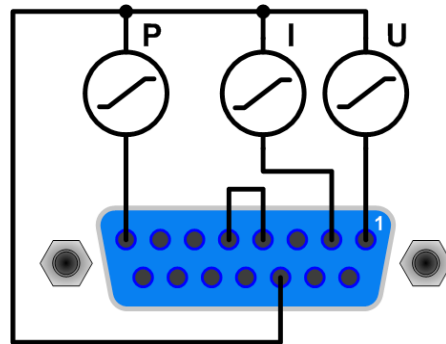

测量实际值

测量监控输出脚的实际值与远程控制模式无关。因为没有功率监控输出，只能测量到电压和电流监控。VMON与CMON引脚的参数通过0...10V或0...5V代表0...100%的实际直流输出值。

使用外部模拟倍增器，可以计算出功率兼职输出。

连线举例：

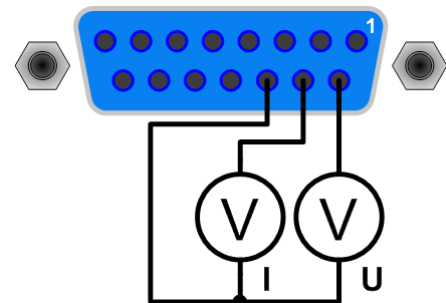

提示

模拟接口的特点是，它具有更多输出引脚，如OVP或CV，能告知用户报警信息或状态（见„10.5. 模拟接口引脚规格“表）。

这些输出脚从内部经一高阻值电阻拉至电压源，不能驱动LED或灯泡。主用作用是通过打开一外部继电器或类似装置吸收电流，从而驱动LED, 灯泡或其它指示器。

相应地，这些输出脚能连到逻辑IC的输入脚。

举例：

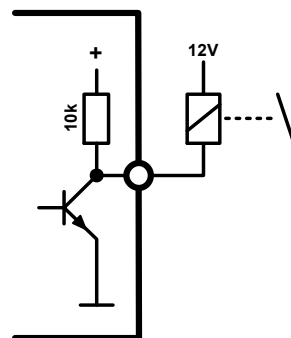

10.5 模拟接口引脚规格

引脚	名称	类型 ⁽¹⁾	描述	水平	电气参数
1	VSEL	AI	设定值: 电压	0...10V 或 0...5V 对应 U_{Nom} 的 0..100%	精确度: < 0.2% @ 0...10V 范围 精确度: < 0.4% @ 0...5V 范围 阻值 $R_i > 100k$
2	CSEL	AI	设定值: 电流	0...10V 或 0...5V 对应 I_{Nom} 的 0..100%	
3	N.C.				不连
4	DGND	POT	参考电位		+Vcc, 数控和状态信号
5	REMOTE	DI	在内控和外控间切换	外控 = LOW***, $U_{Low} < 1V$ 内控 = HIGH, $U_{High} > 4V$ 内控 = 开	电压范围 = 0 ... 30V 输出 5V 时, $I_{Max} = +1mA$ 发送: 开集电极对 DGND
6	OT	DO	过温错误	OT/PF = HIGH, $U_{High} > 4V$ OT = LOW***, $U_{Low} < 1V$	准开集电极上拉至 Vcc** 输出 5V 时, 电流最大 +1mA $U_{CE} = 0.3V$ 时, $I_{Max} = -10mA$ $U_{Max} = 0...30V$ 短路保护对 DGND
7	N.C.				不连
8	PSEL ⁽³⁾	AI	设定值: 功率	0...10V 或 0...5V 对应 P_{Nom} 的 0..100%	精确度: < 0.5% @ 0...10V 范围 精确度: < 1% @ 0...5V 范围
9	VMON	AO	实际值: 电压	0...10V 或 0...5V 对应 U_{Nom} 的 0..100%	$I_{Max} = +2mA$ 时, 精确度 < 0.2% 短路保护对 AGND
10	CMON	AO	实际值: 电流	0...10V 或 0...5V 对应 I_{Nom} 的 0..100%	
11	AGND	POT	模拟信号参考电位		-SEL, -MON, VREF 信号
12	N.C.				不连
13	REM-SB	DI	输出关闭	关 = LOW***, $U_{Low} < 1V$ 开 = HIGH, $U_{High} > 4V$ 开 = OPEN	电压范围 = 0...30V 输出 5V 时, $I_{Max} = +1mA$ 发送: 开集电极对 DGND
14	OVP	DO	过压错误	OVP = HIGH, $U_{High} > 4V$ 无 OVP = LOW***, $U_{Low} < 1V$	准开集电极上拉至 Vcc ** 输出 5V 时, 电流最大 +1mA $U_{CE} = 0.3V$ 时, $I_{max} = -10mA$ $U_{Max} = 0...30V$ 短路保护对 DGND
15	CV	DO	指示电压调整启用	CV = LOW***, $U_{Low} < 1V$ CC = HIGH, $U_{High} > 4V$	$U_{Max} = 0...30V$ 短路保护对 DGND

* AI = 模拟输入脚, AO = 模拟输出脚, DI = 数字输入脚, DO = 数字输出脚, POT = 电位脚

** 内部上拉电压约为 13...14V

*** 默认设定, 可在菜单设置下更改

11. PV - 太阳能电池板的模拟

内置的光伏功能可使本电源能模拟太阳能电池板的特性，它由硬件和软件两方面结合而成。PV功能可在产品设置菜单下激活和停用，如章节„7.8. 激活光伏功能“所描述。若停用，它就以标准电源的特性工作。若激活，设定功率直接受设定电流的影响，形成一个电压-电流-功率动作，类似于太阳能电池板特性的曲线。

11.1 特殊条件

下列适用于PV功能的操作：

- 如果输出关闭，可设定功率和电流起始值
- 如果输出打开，设定功率不可更改，只能根据设定电流计算
- 如果输出打开，设定功率的显示随设定电流的调整而变动
- 可以如前板手控操作方式一样，经数字或模拟接口远程控制PV功能
- 再次关闭输出时，最后一次打开输出前设定的起始值被保存
- 功率的计算基于设定电流，且由产品最大功率值限定

11.2 设置和操作

连接DC-AC逆变器后，运行太阳能电池板特性模拟的操作程序如下：

1. 关闭电源直流输出，激活PV功能，按照即将模拟的太阳能电池板特性，调节初始设定功率和电流。



图 11. 调整太阳能电池板短路电流



图 12. 调节最大功率值

2. 打开直流输出，此时功率值不可再更改。
3. 直流输出端会输出一计算的理想电压（如下）。
4. 打开DC-AC逆变器。

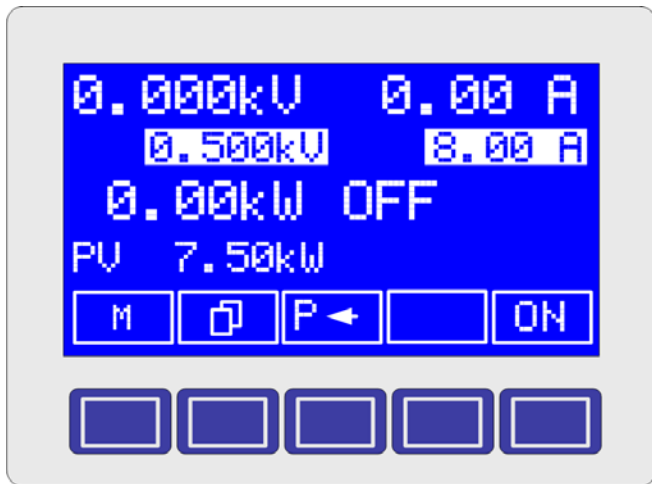
电源会将调节后的初始值转为模拟的太阳能电池板的功率特性曲线。下图曲线描述了范例中，初始电流= 8A，初始功率(MPP) = 8kW，然后根据U-I特性自动计算 U_{MPP} 和 U_{Idle} 。

提示：随同本操作指南，您还会看到一张光碟，里面存有以Microsoft Excel表格制作的计算公式，一台PV型号一个表格。可在这些表格内输入与模拟太阳能电池板相同的初始值，以便产生并显示最终的特性曲线。

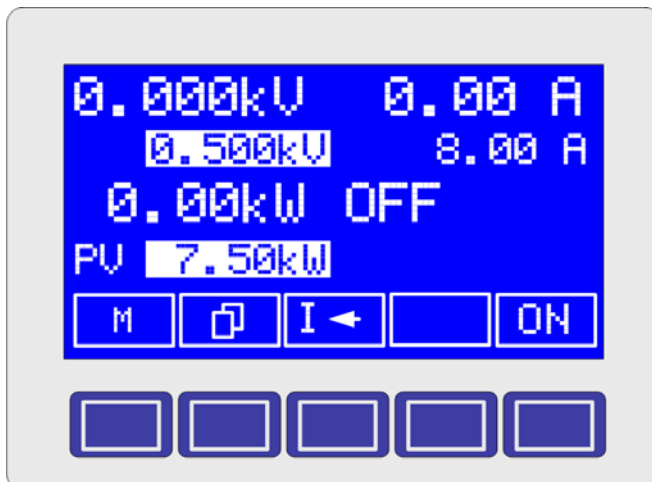
此时可对逆变器进行测试。为了模拟不同的光量条件，可以接着进行下面的步骤

5. 调节电源的设定电流。

当输出再次关闭时，功率和电流被重设为初始测试值。

注意！

直流输出电压（或模拟太阳能电池板的电压）取决于功率和电流的设置。错误的数值可能会导致输出电压高于DC-AC逆变器可承受电压。为了保护逆变器，建议总是将过压保护极限(OVP)设为逆变器最大输入电压。见7.6.1章节下Uovp项目。

11.3 提示和限制条件

- 测如果产品通电后，输出条件还没恢复为，则停止使用该功能。见章节„7.1. 定义操作参数“下的小节““电源打开”后的输出状态”。
- 经模拟接口遥控时，关闭输出后，电流和功率预设值（见上述）不能恢复。因为PSEL和CSEL设定值输入脚不断地设定新的数值，于是在OFF模式，预设值将为预设于输入引脚的最后那个值。
- 如果PV模式在设置菜单下（见„Options“菜单）被激活，函数管理器(SEQ)则不可用。



图 13. 模拟的期望PV曲线

12. HS – 高速跃变

本电源还有一HS功能，由于减少了输出容量，使输出电压具有更好的动态特性。

- 此功能为永久性更改，不可暂停使用，而且会影响某些标准技术参数。见下页列表。

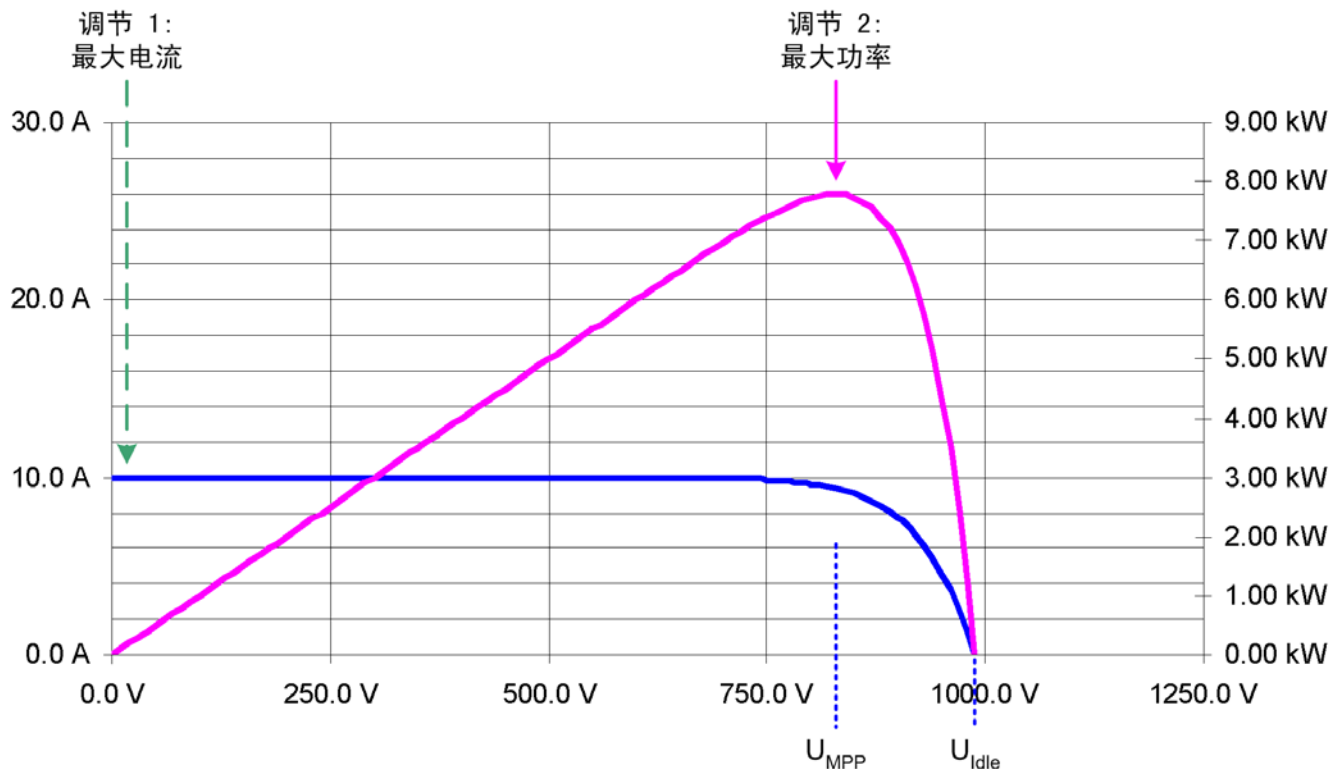

过冲电压危险！

带高速选项功能的电源可能在更换负载时，于输出端产生很高的过冲电压，连接前必须检查连接负载的耐电强度！

12.1 限定条件

- 不具备远程感测操作和串联连接，也不允许进行该类操作！
- t_{fall} 下降时间取决于负载，用户也可根据已知输出容量计算出来。
- 若不遵守长期脉动操作下的已知时间和功耗，将丧失保修索赔权力。

12.2 术语解释

C_{out}

改版后产品的剩余输出容量，可用来计算输出电压的动态时间值。

$U_{min} > / P_{min} >$

建议设置的产品应该操作的最小输出电压与最小实际功率。低于这些值，输出纹波将高于上表列出的参数。

下降时间

与上升时间一起，这是输出电压动态特性的重要参数。该值最初取决于负载的内阻。

上升时间

与下降时间一起，这也是输出电压动态特性的重要参数。该值最初取决于输出容量。负载内阻和调节的极限电流。

12.3 基本操作指南

只要不超过某一总内部功耗，就允许长期远程控制，并形成一个大 $\Delta U/\Delta t$ 。利用 $dU_{max} = \sqrt{(F / f)}$ (如果已知频率值) 或 $f_{max} = F / dU^2$ (如果已知压差)公式计算， $F = 192000$ 针对长期脉动操作，为脉动操作的频率， dU 为上升或下降缘的压差， F 为因素。这儿的长期脉动操作指很多个小时或很多天的操作。短期操作指，比如运作几分钟然后暂停相同时间，此时允许较高的负载动态， $F = 256000$ 。

建议设置的产品应该操作的最小输出电压与最小实际功率。低于这些值，输出纹波将高于上表列出的参数。

12.4 1500V型号的特殊说明

极端脉冲型空载，比如： $0\% I_{nom} \rightarrow 5\% I_{nom}$ 时，它会产生一高达+100V的电压。一般情况下电压上升到40V...60V是典型值。

下降时间缘取决于负载。比如：带1A的恒定负载， t_{fall} 将为~67V/ms，在空载情况下，低于0V时一般为1.7s。

12.5 可变技术参数

型号	600V / 70A	1000V / 30A	1500V / 30A
输出电容容量 C_{out}	34 μ F	22.5 μ F	15 μ F
恒压操作时的HF纹波 (BW=20MHz)*	<3V _{pp}	<600mV _{pp}	<1.5V _{pp}
恒压操作时的LF纹波 (BW=20MHz)*	<2.2mV _{pp}	<60mV _{pp}	<1V _{pp}
恒压操作时的纹波 (BW=300kHz)*	<700mV _{eff}	<160mV _{eff}	<270mV _{eff}
恒压操作时的HF纹波 (BW=20MHz)*	<300mA _{pp}	<30mA _{pp}	<40mA _{pp}
恒压操作时的NF纹波 (BW=20MHz)*	<4000mA _{pp}	<8mA _{pp}	<40mA _{pp}
恒压操作时的纹波 (BW=300kHz)*	<180mA _{eff}	<10mA _{eff}	<14mA _{eff}
从10%...90% I_{Max} ** (在 CV模式下)的调整时间	<4ms	<2ms	<2ms
从90%...10% I_{Max} ** (在 CV模式下)的调整时间	<4ms	<3ms	<2ms
从10%...90% U_{Nom} (空载)的上升时间 t_{Rise}	<1,2ms	<3,2ms	<1ms
从10%...90% U_{Nom} (带载70%)的上升时间 t_{Rise}	<1,6ms	<4ms	<1.2ms
ΔU 脉动操作下的 f_{Max} 值	250Hz	150Hz	500Hz
从100%...10% (带1%的阻性负载)的下降时间 t_{Fall}	<190ms	<350ms	非重要参数
可能产生的过冲电压 (脉动操作下)	up to 150V	高至150V	高至100V
建议 $U_{min} > I_{Pmin}$	40V/100W	40V/160W	60V/240W

* 测量条件: $U_{out} \geq 10\%$, $P_{out} \geq 5\%$

** I_{Max} 或者等于 I_{Nom} (对于无功率限制的产品) 或者 $I_{Max} = P_{Set}/U_{Set}$ (对于有功率限制的产品)

13. 其它应用

13.1 共享总线模式下的并联

共享总线操作为了使并联下运行的多台设备获得均衡的负载电流。

重点: 在该操作模式下, 输出电压最高的产品控制并决定整个并联连接下产品的输出电压。意思是, 系统内的任何产品都可能但当此角色。故建议选择某一台机来控制整个系统的同时, 要将其余机台的设定电压设为需求最小值。电压和功率设定值也可设为100%。若不用这样, 对每台机设定平均值, 这样方可获得所需总值。

若有一台机坏掉, 会终止运作。而并联连接上的其他产品则继续工作, 且无间断。这就是冗余操作。

若产品出现错误, 如过温 (OT) 或过压, 输出电压会上升或下降至剩余产品中电压最高的值。

共享总线操作“Share”端子的连线方式在„5.8. “Share” (共享)端“章节内有详细解释。也可参考图14。

 提示

若需使用远程感测, 建议仅连到决定整个系统电压值的主机“Sense”输入端上。

 注意!

此为纯粹的模拟连接。任何单机上不形成总实际值。

 注意!

即使具有共享总线的非3U系列产品, 仍不可与3U系列并联!

13.2 串联

两台或两台以上本系列产品之间不可串联。

14. 其它附件和选项功能

14.1 附件和选项

有下列附件可选:

a) 数字接口卡

还配USB, RS232, CAN, GPIB/IEEE (仅SCPI) 或以太网/LAN (仅SCPI)用可插拔式数字接口卡。每款产品型号都有一个接口卡插槽。

b) 扩展模拟接口卡

还配可插拔式、电隔离、25针模拟接口卡。关于详细介绍, 请参考接口卡操作指南。

可供下列选项:

a) 水制冷

本产品可内置水制冷模块。水制冷用来防止因过热而过早关断功率输出。

b) 内阻调整

该选项可以后购买, 并在产品设置菜单下用代码解锁。解锁后, 用户可选择U//P或U//R操作。在U//R模式下不可调节功率设定值, 只能在产品设置下定义极限。

 提示

在解锁这个选项前, 最终需要更新产品固件。请咨询您的供货商!



图 14. 共享总线上的并联连接

14.2 固件更新

只有当产品出现错误行为或者应用新功能时才需进行产品固件更新。

要更新一台产品固件，需要用到某一数字接口卡，新的固件文档，称作“更新工具”的Windows软件。

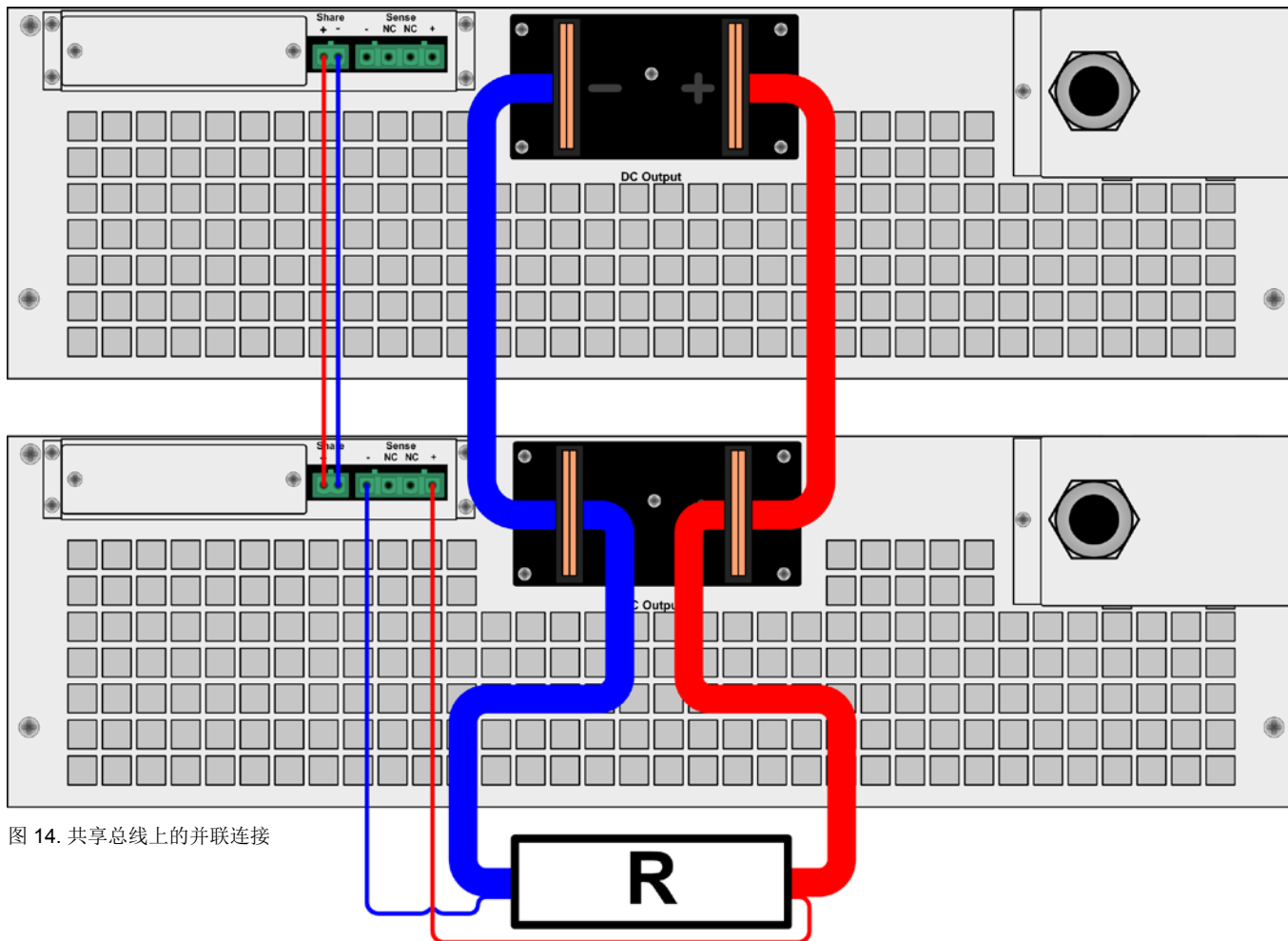
下列这些接口卡才能用于固件更新：

- IF-U1 (USB)
- IF-R1 (RS232)
- IF-E1 (Ethernet/USB)

如果手上没有一张上述接口卡，则不可更新。请立即联系您的产品销售方寻求解决方案。

产品对应的更新工具和固件文档可从产品制造商网站获取，或者发邮件索取。更新工具将会指导用户整个半自动更新过程。

14.3 选项：内阻

可解锁选项功能“内阻”是给电源的内部电压源增加了一个假象的可变电阻。

在 **Setup operation mode** 菜单下（见章节 7.1. 定义操作参数“）从 U/I/P 模式转换到 U/I/R 模式就可激活 U/I/R 操作模式。设定电压与电源的空载电压 U_0 是相关的。根据产品的 $I_{act} \cdot R_i$ 可降低空载电压。该电压值的计算公式如下：

$$U_{Set} = (U_0 - I_{Act} \cdot R_i) \Big|_{I_{set}, P_{set}}$$

图形解释：

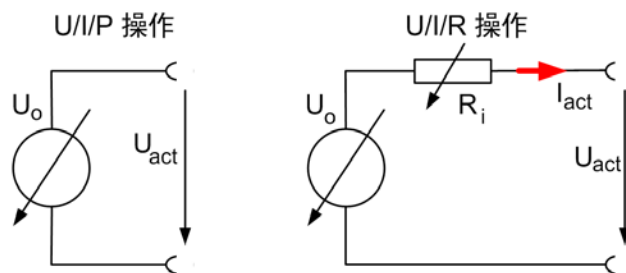

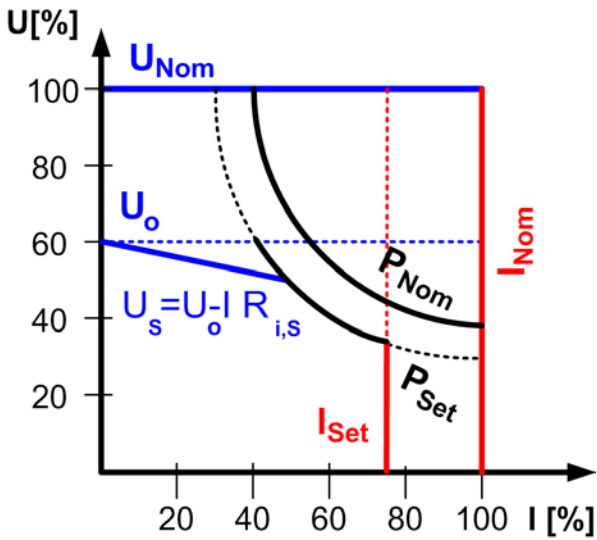

CR 当内阻控制被激活，且设为U/I/R操作模式，将显示这个图标。

U/I/R模式被激活时，显示的是内阻 $R_{i,Set}$ 而非功率 P_{Set} 。但是功率实际值仍然显示。

U/I/R模式有下列限制：

- 针对具有可调功率的产品，激活U/I/R模式会直接停用功率调整。因此只能在菜单下通过参数“ $P_{adj\ max}$ ”设定总输出功率。激活模式时，该数值将立即设为输出的设定功率。然后也可被调节。
- 不可经内置或可选模拟接口控制设定阻值。因此只要U/I/R模式位于激活状态，就不能经模拟接口执行远程控制。
- 多台产品并联或串联后不能运行模式，且不允许这种操作！

可从电源经销商处购买这个解锁编码。购买时需要告知产品系列号，因为解锁码是与之相连的。

14.4 联网

下图描述了多台产品在数控状态下以星形（USB，RS232）或车形（CAN，GPIB）配置的连网举例。适用总线系统和接口的限制和技术规格。

通过**USB**，一台电脑可控制多达30台产品，需使用带特制电源的USB集线器。这也基本适用于RS232。区别在于操作和线长。

通过**CAN**，每个地址段上的多达30台电源，可容入新的或现有的CAN总线系统。它们由产品节点和RID（见“7. 产品设置”）组成。

通过**GPIB**，每一条总线限制最多为15台，由一台GPIB主机控制。一台电脑上可安装多台主机，这样可增加可编址单元数。



图 15. 用USB或RS232联网



图 16. 用CAN联网举例，也同样适用于GPIB

About

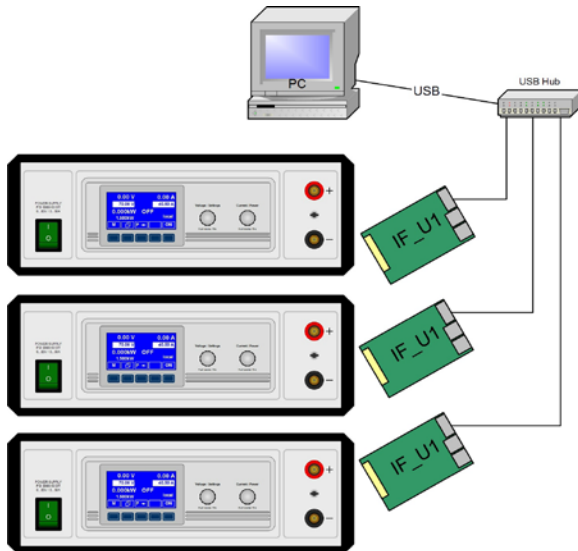
Elektro-Automatik GmbH & Co. KG

Helmholtzstrasse 31-33

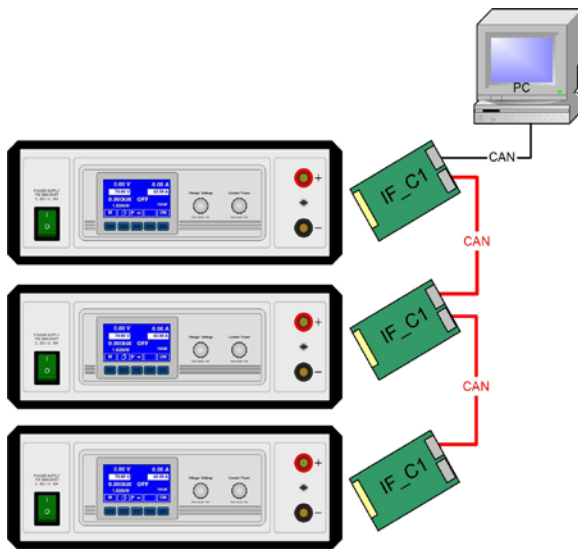
41747 Viersen

Germany

Phone: +49 2162 / 37850

Fax: +49 2162 / 16230

Web: www.elektroautomatik.de

Mail: ea1974@elektroautomatik.de

© Elektro-Automatik

Reprint, duplication or partly, wrong use of this operating guide are prohibited and might be followed by legal consequences.

Danger to life!

Hazardous voltage

The output voltage of some models can rise up to hazardous levels of $>60V_{DC}$!

All live parts have to be covered. All actions at the output terminals have to be done while the unit is switched off from the mains (mains switch OFF) and may only be executed by personnel which is instructed about the hazards of electrical current. Any connection between the load and the unit (at the output terminals) have to be scoop-proof. Applications connected to the power output must be configured and fused in a way that prevents the use of these to cause a damage or worse to the unit by overload or malfunction.

Caution!

The DC output can still have hazardous voltage for a certain time after the output or the device has been switched off!

Keep in mind:

- Only operate the device at a mains voltage as stipulated on the type plate
- Never insert mechanical parts, especially from metal, through the air ventilation slots
- Avoid any use of liquids of any kind in the proximity of the device, they might get into it
- Do not connect voltage sources to the device which are able to generate voltages higher than the nominal voltage of the device
- In order to equip interface cards into the slot at the rear, the common ESD provisions have to be followed
- The interface card may only be plugged and unplugged while the unit is completely switched off (mains switch OFF)
- Aging of the device, as well heavy use may result in unpredictable behaviour of control elements like pushbuttons and rotary knobs.
- Do not connect external voltage sources with reversed polarity to the DC output! The device will be damaged.
- Avoid connecting external voltage sources to the DC output, especially those who can generate voltages higher than specified for the device!

	Page
1. Introduction.....	42
2. Technical specifications.....	42
2.1 Control panel and display.....	42
2.2 Device specifications.....	43
3. Device description.....	44
3.1 Views.....	44
3.2 Scope of delivery.....	47
4. General.....	47
4.1 Prologue / Warning.....	47
4.2 Cooling.....	47
4.3 Opening the device.....	47
4.4 Redundancy.....	47
5. Installation.....	47
5.1 Visual check.....	47
5.2 Input connection (single unit).....	47
5.3 Input connection (multiple units).....	47
5.4 Input fuses.....	47
5.5 DC output terminal.....	47
5.5.1 Terminal types.....	48
5.6 Grounding the output.....	48
5.7 Terminal „Sense“ (Remote sense).....	48
5.8 Terminal „Share“.....	48
5.9 Interface card slot.....	48
6. Handling.....	49
6.1 The display.....	49
6.2 Used symbols.....	49
6.3 Short overview about the display elements.....	49
6.4 Switching the unit on.....	50
6.5 Switching the power output on.....	50
6.6 Adjusting set values.....	50
6.7 Switching the button panel.....	51
6.8 Locking the control panel.....	51
6.9 Changing the location mode.....	51
6.10 Switching to the function manager.....	51
6.11 Activating the menu.....	52
6.12 Parameter pages.....	52
6.13 Alarms, warnings and signals.....	52
6.14 Acknowledging alarms and warnings.....	53
6.15 The function manager.....	53
6.15.1 Configuring the function.....	54
6.15.2 The function layout.....	54
6.15.3 Configuring sequences.....	54
6.15.4 Sequence related parameters.....	54
6.15.5 Defining the sequence points.....	54
6.15.6 Display during the function run.....	55
6.15.7 Controlling the function manager.....	55
7. Device configuration.....	56
7.1 Defining operation parameters.....	57
7.2 Predefining preset lists.....	57
7.3 Adjustment limits.....	57
7.4 Configuring the control panel.....	58
7.5 Configuring the graphic display.....	59
7.6 Supervision.....	59
7.6.1 Voltage supervision.....	59
7.6.2 Current supervision.....	60
7.6.3 Step response supervision.....	61
7.7 Reset to default configuration.....	62
7.8 Activating the photovoltaics feature.....	62
7.9 Unlocking the U/I/R mode.....	62
7.10 Locking the device configuration.....	63

	Page
8. Special characteristics.....	63
8.1 Switching on by power switch.....	63
8.2 Switching off by power switch.....	63
8.3 Switching to remote control	63
8.4 Overvoltage alarm	63
8.5 Overtemperature	63
8.6 Voltage, current and power are regulated	64
8.7 Remote sense is active	64
8.8 Mains undervoltage or overvoltage occurs.....	64
8.9 Connecting different types of loads	64
9. Digital interfaces.....	65
9.1 General.....	65
9.2 Configuring the interface card	65
10. Internal analog interface.....	65
10.1 General.....	65
10.2 Overview D-Sub socket.....	65
10.3 Settings in the device setup.....	66
10.4 Example applications.....	66
10.5 Pin specifications.....	68
11. PV - Solar panel simulation	69
11.1 Special conditions.....	69
11.2 Setup and handling.....	69
11.3 Notes & limitations.....	70
12. HS - High speed ramping	70
12.1 Restrictions.....	70
12.2 Terms explained	70
12.3 General operation instructions.....	71
12.4 Specific instructions for the 1500V model	71
12.5 Altered technical specifications	71
13. Other applications	71
13.1 Parallel connection in Share bus mode.....	71
13.2 Series connection.....	72
14. Miscellaneous.....	72
14.1 Accessories and options.....	72
14.2 Firmware update.....	73
14.3 Option: Internal resistance.....	73
14.4 Networking.....	73

1. Introduction

The high efficiency power supplies of the series PSI 8000 3U are ideally suited for test systems and industrial control facilities by their 19" draw-out case.

Apart from standard functions of power supplies the user can define and recall different presets of set values, supervise set values and actual values by definable limits or create function runs of configurable preset values with the integrated function manager.

Optionally available, digital interface cards provide an even wider spectrum of control and monitoring functions by means of a PC. Another optionally available extension card is the galvanically isolated analog interface IF-A1 which can serve to control the device by external means, like a PLC.

The integration into existent systems is done very comfortably by using an interface card, while there is no need to configure the card at all or with only a few settings.

All models feature an adjustable power regulation circuit, as well as a „Share Bus“ terminal which enables parallel connection with symmetric current distribution.

The integrated options HS (high speed) and PV (photovoltaics) offer a higher dynamics contrary to standard power supply models and enable running tests which are typical for the E.U.T stage of solar inverter production. The PV option will control the power supply according to a certain characteristics.

The main functions at a glance:

- Set voltage, current and power, each with 0...100%
- Adjustable overvoltage threshold 0...110% U_{Nom}
- Optional, pluggable interface cards (CAN, USB, RS232, IEEE/GPIB, Ethernet/LAN, Profibus)
- Optional, analog interface for external control and monitoring with extended features
- Power ratings: 10kW or 15kW
- Temperature controlled fans
- Status indication (OT, OV, CC, CV) in the display
- Supervision function
- Function manager
- Adjustable internal resistance (optional)
- High speed ramping
- Parallel connection with Share bus
- Solar panel simulation with PV

2. Technical specifications

2.1 Control panel and display

Type

Display	Graphics display 128x64 dots
Operating controls:	5 pushbuttons, 2 rotary knobs with pushbutton feature

Displayed formats

The nominal values limit the maximum adjustable range.

Actual values and set values for voltage, current and power are displayed simultaneously, the set value of the overvoltage threshold is displayed separately.

Display of voltage values

Resolution:	4 digits
Formats:	0.0...999.9V 0V...9999V

Display of current values

Resolution:	4 digits
Formats:	0.00A...99.99A

Display of power values

Resolution:	4 digits
Formats:	0.00kW...99.99kW

Display of resistance values

(only with unlocked option „internal resistance control“)

Resolution:	4 digits
Formats:	0.0Ω...999.9Ω 0Ω...9999Ω

Time displays

Times are displayed in 4 automatically switched ranges.

Resolution:	
Range 1:	2ms to 9.999 s
Range 2:	10ms to 59.99s
Range 3:	1:00m to 59:59min
Range 4:	1:00h to 99:59h

Accuracy:

Range 1:	2ms
Range 2:	10ms
Range 3:	1s
Range 4:	1 min

2.2 Device specifications

	PSI 8600-70 3U HS PV	PSI 81000-30 3U HS PV	PSI 81500-30 3U HS PV
Mains input			
Input voltage range	340...460V AC	340...460V AC	340...460V AC
Required phases	L1, L2, L3, PE	L1, L2, L3, PE	L1, L2, L3, PE
Input frequency	45...65Hz	45...65Hz	45...65Hz
Input fuse	6x T16A	4x T16A	6x T16A
Input current	max. 28A	max. 28A	max. 28A
Power factor	> 0.99	> 0.99	> 0.99
Output - Voltage			
Nominal voltage U_{Nom}	600V	1000V	1500V
Adjustable range	0V... U_{Nom}	0V... U_{Nom}	0V... U_{Nom}
Stability at mains fluctuation $\pm 10\% \Delta U_{IN}$	< 0.02%	< 0.02%	< 0.02%
Stability at 0...100% load	< 0.05%	< 0.05%	< 0.05%
Ramp-up time 10...90% at 100% load	max. 30ms	max. 30ms	max. 30ms
Ripple ***	< 400mVpp < 80mVrms	< 800mVpp < 200mVrms	< 1000mVpp < 350mVrms
Accuracy *	$\leq 0.2\%$	$\leq 0.2\%$	$\leq 0.2\%$
Resolution of display	100mV	1V	1V
Remote sense compensation	max. 18V	max. 20V	max. 30V
Overvoltage protection threshold (adjustable)	0...660V	0...1100V	0...1650V
Output - Current			
Nominal current I_{Nom}	70A	30A	30A
Adjustable range	0... I_{Nom}	0... I_{Nom}	0... I_{Nom}
Stability at mains fluctuation $\pm 10\% \Delta U_{IN}$	< 0.05%	< 0.05%	< 0.05%
Stability at 0...100% ΔU_{OUT}	< 0.15%	< 0.15%	< 0.15%
Ripple ***	< 30mApp < 12mArms	< 22mApp < 11mArms	< 19mApp < 13mArms
Accuracy *	$\leq 0.2\%$	$\leq 0.2\%$	$\leq 0.2\%$
Resolution of display	10mA	10mA	10mA
Transient recovery time 10...90% load	< 2ms	< 2ms	< 2ms
Output - Power			
Nominal power P_{Nom}	15000W	10000W	15000W
Nominal power at derating	0... P_{Nom}	0... P_{Nom}	0... P_{Nom}
Accuracy *	$\leq 2\%$	$\leq 2\%$	$\leq 2\%$
Resolution of display	0.01kW	0.01kW	0.01kW
Efficiency	95.20%	95.50%	95.50%
Output - Internal resistance ****			
Max. adjustable resistance	171.4 Ω	666.7 Ω	1000 Ω
Accuracy	< 2%	< 2%	< 2%
Resolution of display	100m Ω	100m Ω	1 Ω
Regulation time of set value to actual val.	~ 2s	~ 2s	~ 2s
Miscellaneous			
Ambient temperature	0...50°C	0...50°C	0...50°C
Storage temperature	-20...70°C	-20...70°C	-20...70°C
Humidity rel.	< 80%	< 80%	< 80%
Dimensions (WxHxD) **	19" 3U 595mm	19" 3U 595mm	19" 3U 595mm
Weight	33kg	25.5kg	33kg
Redundancy	no	no	no
Isolation +output to enclosure	1000V DC	1500V DC	2000V DC
Isolation -output to enclosure		300V DC	
Isolation input to output		2500V DC	
Cooling	by fans, air inlet on the front, air exhaust on the rear		
Safety	EN 60950		
EMC standards	EN 61326, EN 55022 Class B		
Overvoltage class	2		
Protection class	1		
Pollution degree	2		
Operational altitude	<2000m		
Series operation	possible (with restrictions)		
Master-Slave	no		
Parallel operation	yes, with current distribution via Share bus		
Master-Slave	no		
Analogue programming	Via built-in isolated analogue interface or pluggable analogue interface card		
Isolation voltage	Built-in interface: 1500V / Interface card IF-A1: 2000V		
Input range	0...5V or 0...10V, selectable		
Accuracy	$\leq 0.2\%$		
Input impedance	53k Ω		
Digital programming	Via pluggable interface cards: RS232, USB, CAN, GPIB, Ethernet		
Article number	09901444	09901438	09901439

* Related to the nominal value, the accuracy defines the maximum allowed deviation between set value and actual value.

Example: a 80V model has min. 0.2% voltage accuracy. This is 160mV. When setting a voltage of 5V and with an allowed maximum deviation of 160mV, the resulting actual value could be between 4.84V and 5.16V.

** Enclosure dimensions only, not overall dimensions

*** MPP value: HF 0...20MHz, RMS value: LF 0...300kHz

**** Unlockable option

3. Device description

3.1 Views

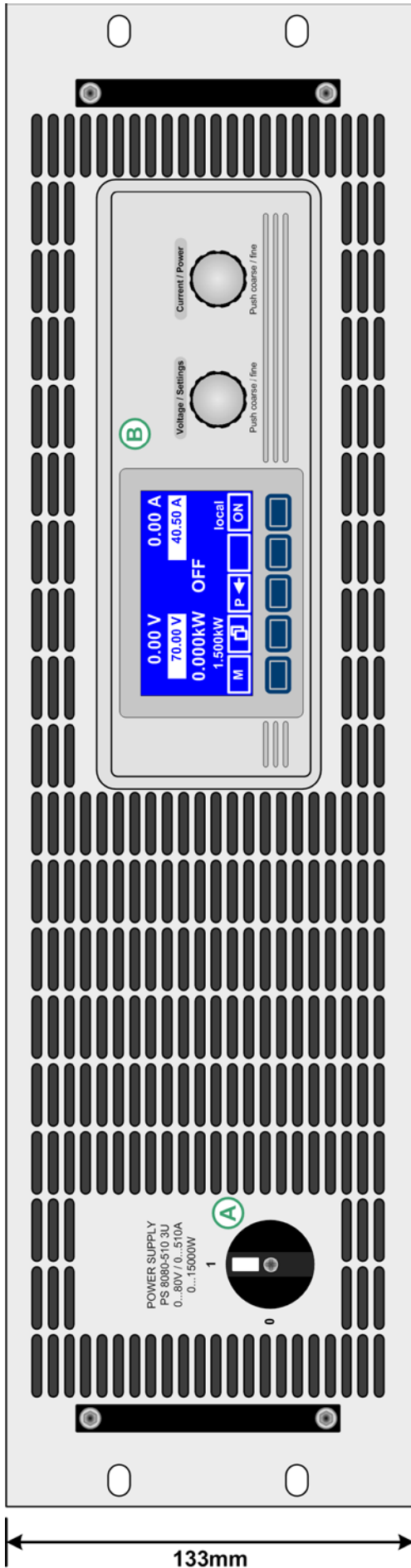

Figure 1

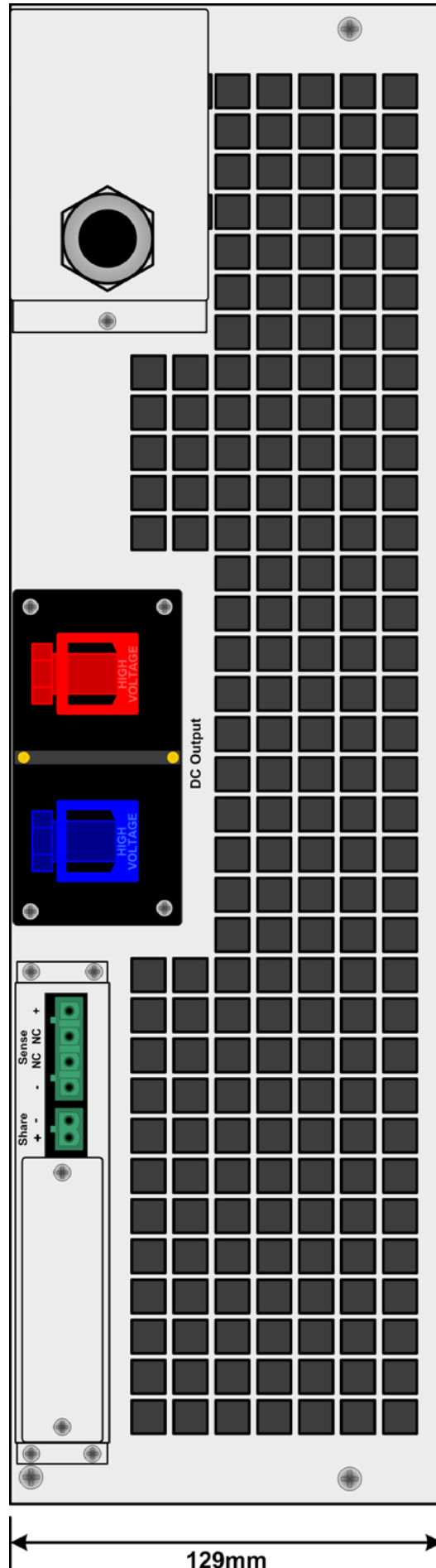

Figure 2

- A - Mains switch
- B - Control panel
- C - Interface card slot
- D - Share bus and remote sense terminals
- E - DC output
- F - AC input

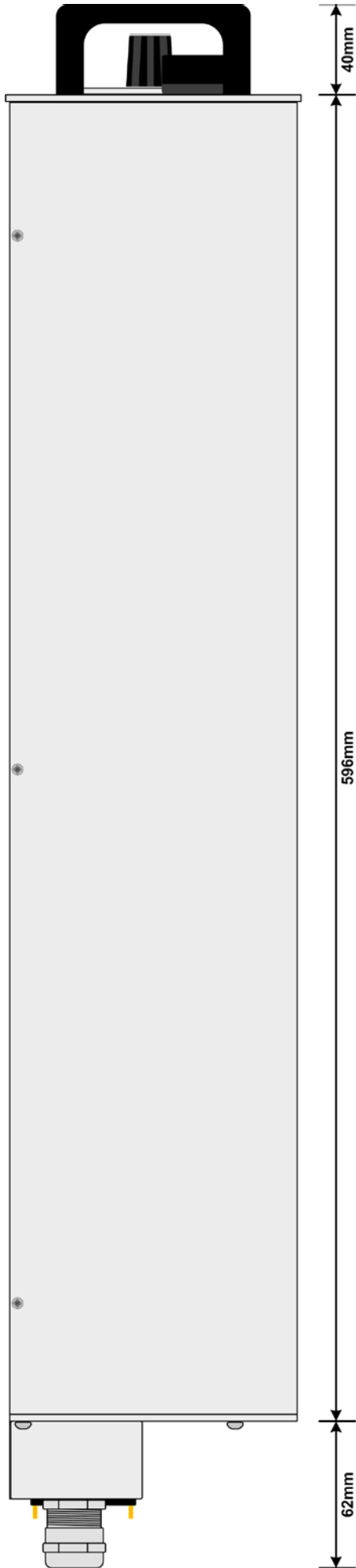

Figure 3

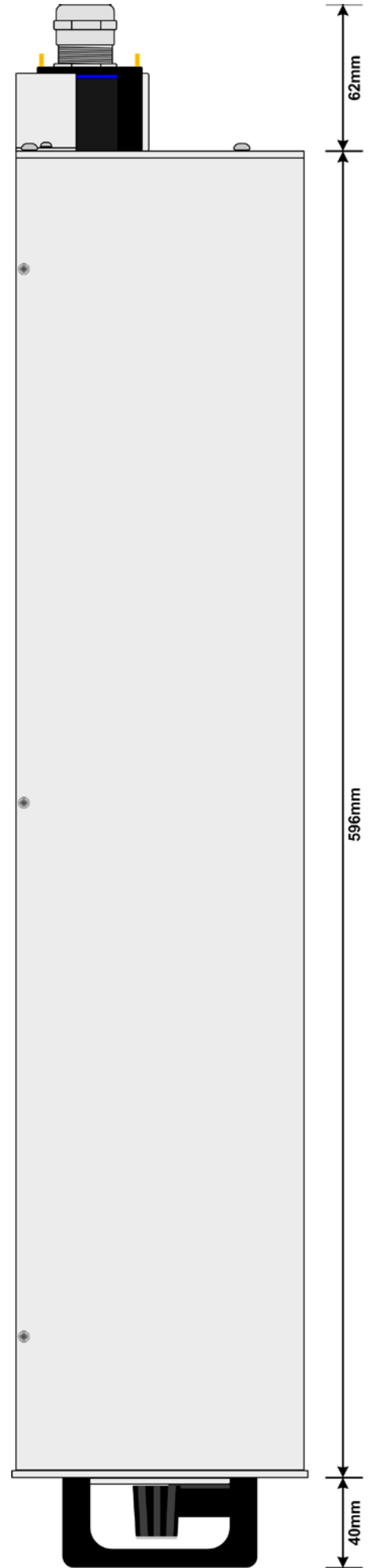

Figure 4

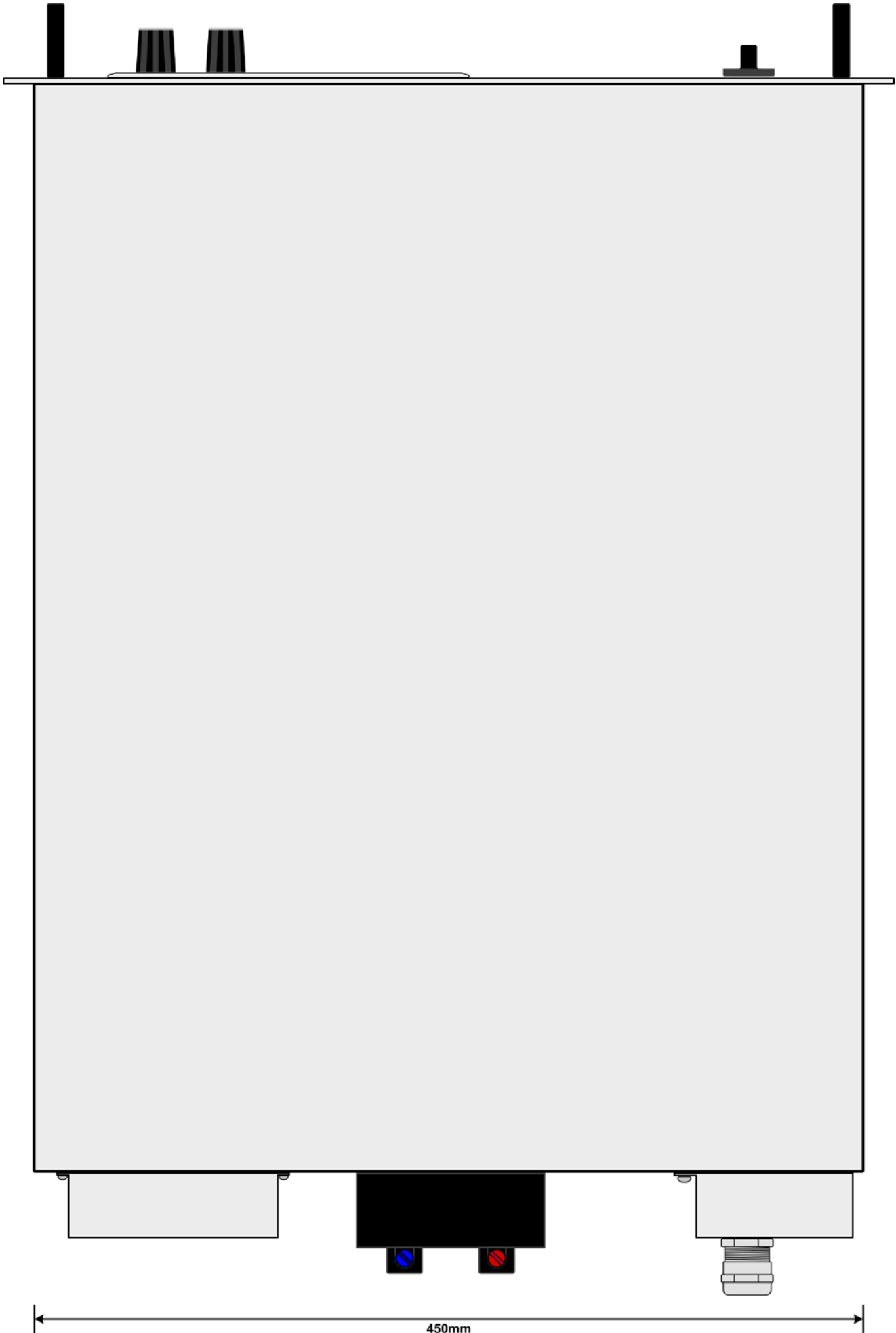

Figure 5

450mm

3.2 Scope of delivery

- 1 x Power supply unit
- 1 x Printed user manual(s) with CD
- 1 x Plug for Share bus (plugged)
- 1 x Plug for remote sense (plugged)

4. General

4.1 Prologue / Warning

This operating guide and the device are intended to be used by users who know about the principle of a power supply. The handling of the device should not be left to persons who are unaware of the basic terms of electrotechnology, because these are not described in this manual. Inappropriate handling and non-observance to the safety instructions may lead to a damage of the device or loss of warranty!

4.2 Cooling

The air inlets on the front and the air outlets at the rear have to be kept clean to ensure proper cooling. Take care of at least 20cm distance at the rear to any surrounding objects in order to guarantee unimpeded air flow.

4.3 Opening the device

When opening the unit or removing parts from the inside with tools there is risk of electric shock by dangerous voltages. Open the unit only at your own risk and disconnect it from the mains before.

Any servicing or repair may only be carried out by trained personnel, which is instructed about the hazards of electrical current.

Opening the unit is normally only required to replace a fuse.

4.4 Redundancy

Certain models feature redundancy. It means, they contain two or three power stages and if at least one power stage is remaining operable, because other power stages have switched off due to overheating, the power supply will continue to provide power to the output.

5. Installation

5.1 Visual check

The unit has to be checked for signs of physical damage after receipt and unpacking. If any damage is found, the unit may not be operated. Also contact your dealer immediately.

5.2 Input connection (single unit)

The unit's AC input requires a three-phase supply, plus ground (PE).

The connection is done with cables of proper cross section. See table for examples. The table takes regard of connecting one unit.

	L1		L2		L3	
	∅	I _{max}	∅	I _{max}	∅	I _{max}
10kW	4mm ²	28A	4mm ²	16A	4mm ²	16A
15kW	4mm ²	28A	4mm ²	28A	4mm ²	28A

We recommend to use

for 10kW/15kW models: at least 4mm²

for every phase and ground (PE).

5.3 Input connection (multiple units)

If multiple units of same or different power rating are connected to the same three-phase main connection, it is required to consider the current of the phases in order to gain a balanced distribution. Models with 10kW will cause an unbalanced current distribution when using 1 or 2 units. On the other hand, 3 units would be ideal.

Example configuration for 10kW models:

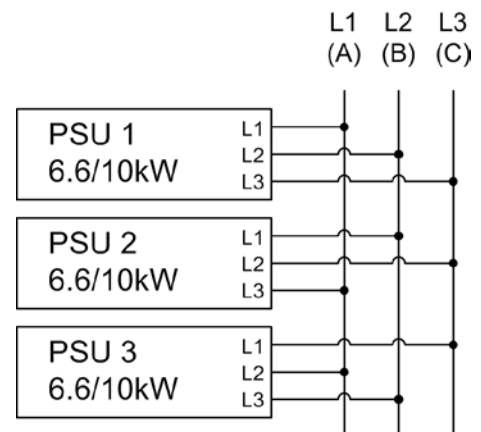

5.4 Input fuses

Fuse protection of the unit is done with up to 6 fuses of type Littlefuse F16A/500V and size 6.3x32mm. They are located inside the unit on a mains filter board which is located behind the front plate. In case fuses need to be replaced, the top cover has to be removed.

5.5 DC output terminal

The power output is located on the rear of the device.

The output is **not** fused! In order to avoid damage to the load application, always take care for the nominal values of the load.

The cross section of the load cables depends on several conditions, like the output current, the lead length and the ambient temperature.

Up to 1.5m cable length we recommend to use:

up to 30A:	6mm ²	up to 70A:	16mm ²
up to 90A:	25mm ²	up to 140A:	50mm ²
up to 170A:	70mm ²	up to 210A:	95mm ²
up to 340A:	2x70mm ²	up to 510A:	2x120mm ²

at least per DC output pole (flexible wire).

Single cables like, for example, 70mm² can also be replaced by 2x 35mm².

When using longer cables it is required to increase cross section in order to avoid voltage drops and unwanted heating.

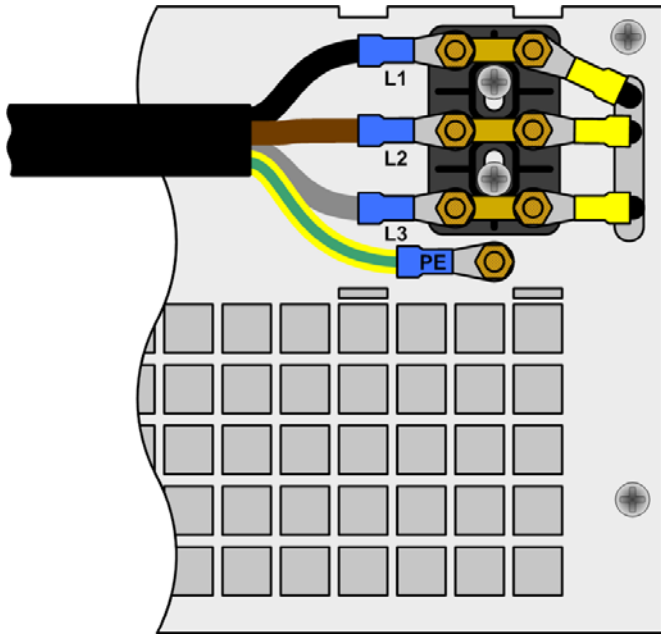
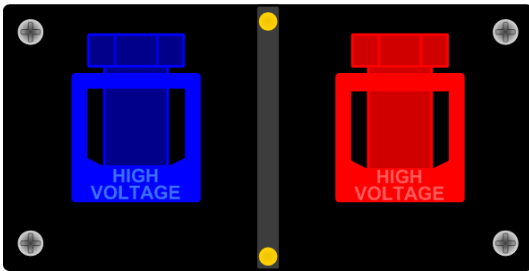

Figure 6. Input connection 10kW/15kW

5.5.1 Terminal types

- Models from 400V output voltage
Screw-clamp terminal, plastic
Recommendation: ring cable lugs 6mm



5.6 Grounding the output

⚠ Attention!

Grounding of the DC minus (-) output of single units or multiple units in parallel is always possible. Grounding the DC plus (+) output is only allowed for models of up to 300V nominal voltage!

⚠ Attention!

When grounding one of the DC output poles take care if the consumer, for example an electronic load, is also grounded on one of its poles! It may become a short-circuit!

5.7 Terminal „Sense“ (Remote sense)

In order to compensate the voltage drop along the load cables, the power supply can „sense“ the voltage at the load instead at the output. It will regulate the output voltage so that the desired voltage is provided to the load. For maximum regulation see section „2.2. Device specifications“, information „Remote sense compensation“.

The connection for remote sense is done at the terminal „Sense“ on the rear side. Also see section 3.1.

⚠ Attention!

(+) Sense must only be connected to (+) at the load application and (-) Sense must only be connected to (-)! Else both systems can take damage.

For additional information also see section „8.7. Remote sense is active“.

5.8 Terminal „Share“

In case Share bus operation is wanted, the „Share“ terminal of the concerning units just have to be connected to each other:

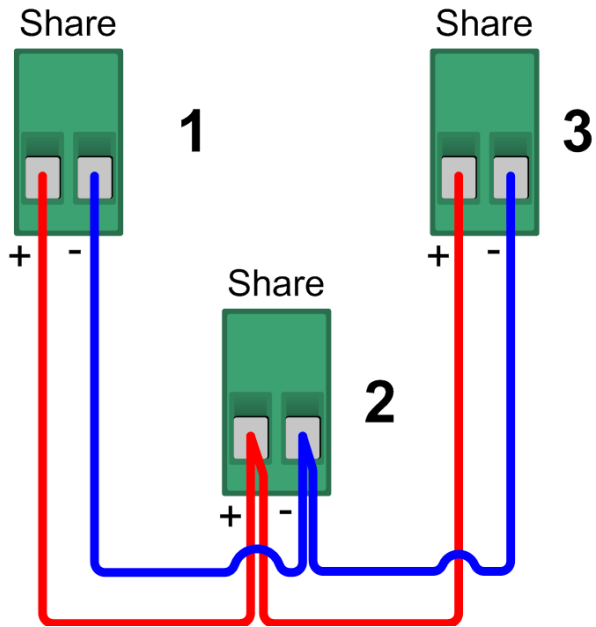

Nothing more required. For details about Share bus operation refer to section „13.1. Parallel connection in Share bus mode“.

⚠ Attention!

Share bus connection with units different to 3U series, which also feature a Share bus, in order to build parallel connection is not allowed!

5.9 Interface card slot

The unit can be equipped with an optional interface card. The slot to insert the card is located at the rear side. Further information about the interface cards can be found in section „9. Digital interfaces“, in the separate operating guide for the interface cards and on the quick installation guide for the interface cards.

6. Handling

6.1 The display

Figure 8 below shows an overview of the graphical display. During normal operation, the display shows the actual and set values of voltage (upper left), current (upper right) and power (lower left). In device setup mode, it display parameters and settings.

In case the optional „internal resistance control“ is unlocked, the power set value might be replaced by the internal resistance set value, depending on what is selected in the device setup.

6.2 Used symbols

In the following description the display and operating elements are marked by different symbols.

 = **Displayed only**, all elements which are only displayed and which represent a state are marked with this symbol

 = **Parameter**, changeable values are marked with this symbol and are emphasised

 = **Menu items**, selectable, lead to the next sublevel or to the bottom level with parameters

Brackets {...} mark possible options or adjustment ranges for parameters.

6.3 Short overview about the display elements

 **70.00 V** Actual value of the output voltage

 **35.00 A** Actual value of the output current

 **1.300kW** Actual value of the output power

During normal operation the actual values are displayed by bigger numbers.

 **70.00 V** Set value of voltage

Target value of the desired output voltage (left knob). The value is adjusted in coarse (see section 6.6 for step widths) or fine (always rightmost digit). Switching between coarse and fine is done with the pushbuttons on the left rotary knob.

 **40.50 A** Set value of current

Target value of the desired output current (right knob). The value is adjusted in coarse (see section 6.6 for step widths) or fine (always rightmost digit). Switching between coarse and fine is done with the pushbuttons on the right rotary knob. It might be required to push button  before the set value is adjustable.

 **1.500kW** Set value of the power

Target value of the desired maximum output power (right knob). In order to set the value, button  has to be pushed before. The value is adjusted in coarse (see section 6.6 for step widths) or fine (always rightmost digit).

 **10.00 Ω** Set value of internal resistance (optional)

Target value of the desired internal resistance value (right knob). This set value replaces the power set value if the internal resistance control is unlocked and U/I/R mode has been selected in the device setup. In order to set the value, button  has to be pushed before.

The state of the power output is displayed in the bottom right corner of the display.

 **{ON,OFF}** State of the power output

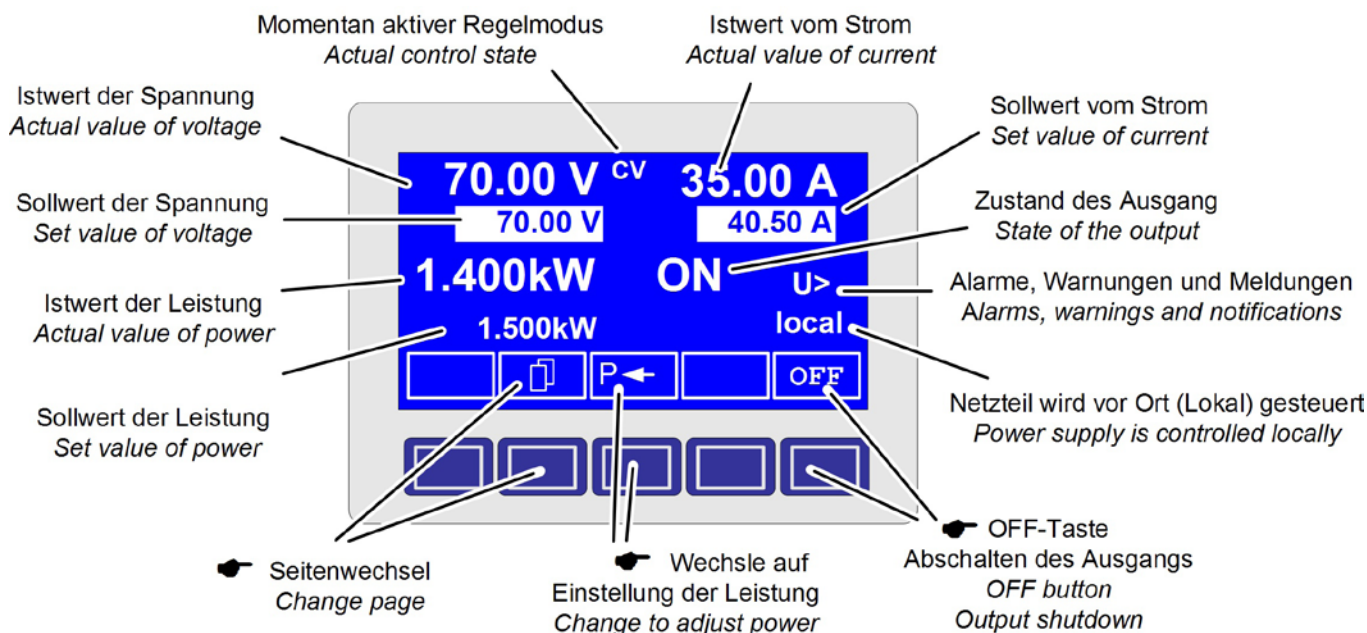





Figure 7

The currently active control mode is displayed to the right of the related actual values. For instance, the abbreviation „CV“ is displayed next to the actual value of voltage, because it means that „Constant voltage“ mode is active. The output values are limited by the active control mode:

 - limited by the voltage set value
(= Constant Voltage)

 - limited by the power set values
(= Constant Power)

 - limited by the set value of current
(= Constant Current)

 - limited by the set value for internal resistance (optional at U//R mode), indicated next to the actual voltage
(= Constant Resistance)

Additionally to the state of the output an alarm, a warning or a signal can be displayed:

 Example:  = Overtemperature

 Example:  = Overvoltage

 Example:  = Overcurrent

The location from where the unit is currently controlled is displayed below the output state. This location is absolute, which means that you cannot control the unit from elsewhere without changing the location.

 Control only possible at the unit

 Remote control via communication interfaces (IF-C1, IF-R1, IF-U1 etc.)

 Remote control via built-in or optional, analog interface

6.4 Switching the unit on

The unit is switched on with the mains switch. After it has been switched on, the displays shows the device type and, if programmed, a user text.

The user text can be entered via one of the digital interface cards using an included LabView VI. This text is intended to identify a single unit in a complex environment of multiple units.

After the internal system has been verified and has booted, the last state of the power supply (set values, alarm management etc.) is restored. The return state of the output after a mains loss (power fail error) or after the unit was switched on can be set in the  **Profile** menu.



6.5 Switching the power output on

By pressing the  button the power supply output is switched on, as long as it is not overridden by the input pin „REM-SB“ (13) of the built-in analog interface or optional analog interface card IF-A1, because the pin has higher priority. If so and when trying to switch the output on by the button, the display will indicate the status text „auto ON“, noticing the user that the output will switch on as soon as the override from the pin is removed.

Note

In local state (see section 6.9), the pin REM-SB of the analog interface (internal or external) is inoperative.



The display should then show the output condition with „ON“.





The  button switches the power supply output off. This state is displayed with .

6.6 Adjusting set values

Note

Set values can be adjusted in coarse or fine steps (see table below for step widths). Switching from coarse to fine or vice versa is done with the two rotary knobs next to the display. These also have a pushbutton feature. The last selected mode, coarse or fine, is not saved when the device is switched off. After powering the device, coarse mode is active by default with firmware C3.13 or higher, else fine mode is default.

As long as  or  is not displayed, the set values for voltage, current or power can be set manually.

The way of set value submission is selected in the device setup at  **Accept set value**. The setup is accessed with button  ->  **Profile** ->  **General settings** ->  **Control panel**. See „7.4. Configuring the control panel“ for details.

Direct setting of the set values

Using the rotary knobs directly sets the set values.

The left rotary knob adjusts the voltage. The set value of the voltage is displayed invertedly while it is selected and adjusted.

The right rotary knob either sets the set value for the current, for the power or internal resistance (optional, unlockable, with U//R mode chosen). The selected set value is displayed invertedly.

With the **SELECT** keys

 the set value for the power, with

 the set value for the internal resistance or with

 the set value for the current is selected.

The maximum adjustable power can also be limited.

Set values are submitted

Alternatively to the direct adjustment of set values you can choose to set the set values only after submitting them with the **RETURN** button. See section „7.4. Configuring the control panel“ for details. The set values can still be changed with the rotary knobs, but are not set to the output as long as they're not submitted. While the set value is unchanged, only its unit is displayed invertedly. If the set value is changed it is also displayed invertedly.

The **SELECT** keys switch from current adjustment to power adjustment for the right rotary knob. The chosen set values are not submitted to and set by the power supply until then.



Pressing the **RETURN** button submits the set values.



Pressing the **ESC** button discards the new set values and the old set values are displayed again.



Note

The adjustment of the resistance set value is only accessible after the optional „internal resistance control“ is unlocked (see section 7.9).



Note

The resistance set value is adjustable from 0Ω up to $20 \cdot U_{nom} \div I_{nom}$. Means, for example, at a device with $U_{nom} = 1000V$ and $I_{nom} = 30A$ it can be adjusted to a maximum of $666,6\Omega$.

Using predefined set values

A table of up to 4 sets of set values is accessible in the menu **Preset List** (see „7.2. Predefining preset lists“). The left knob selects the preset list and with the **RETURN** button the set is submitted or discarded with the **ESC** button.



The chosen set is still 1. After the **RETURN** button is pressed, the set values of set 3 are submitted to the power supply. The display then shows the new set values of set 3.

The **MEMORY** button can be used to jump straight to the menu page where the preset lists are defined and there they're edited and submitted with **RETURN** as usual.

Step widths for set value adjustment

Voltage			Current		
Nom. val	Coarse	Fine	Nom. val	Coarse	Fine
600V	5V	0.1V	30A	0.2A	10mA
1000V	10V	1V	70A	0.5A	10mA
1500V	10V	1V			

Power			Resistance		
Nom. val	Coarse	Fine	Nom. val	Coarse	Fine
10kW	0.10kW	0.01kW	171/667 Ω	0.1 Ω	1 Ω
15kW	0.10kW	0.01kW	1.000k Ω	1 Ω	10 Ω



Note

The resolution of the set value adjustment in some cases is, depending on the nominal values, higher than the one of the output voltage. Thus it can happen that the output voltage only changes every 2 or 3 steps

6.7 Switching the button panel



The button **PAGE** is used to switch to another button panel. The new button assignments of the other panel allow the user to lock the control panel, switch to the function manager or set the location mode.

6.8 Locking the control panel



The button „Lock button panel“ locks all buttons, except itself, and the rotary knobs. The unit is now locked from manual access, so that no set value can be changed or no menu is accessible. The locking mode can be set up in the menu. The control panel can be either completely inactive or it can exclude the **OFF** button (the unit is then locked but can be switched off and on by the **OFF** button). See also „Control panel lock“ in section „7.4. Configuring the control panel“.



After the control panel was locked it changes to this icon. The button can be used to unlock the control panel again, if button



is pressed within 2s.

6.9 Changing the location mode



With the button **EXT** the user enables the remote control of the unit via a digital or analog interface card and deactivates the **local** mode.



With the hand button the user sets the unit into strict **local** mode, so that it is only manually controllable. Access by any interface, analog or digital, is then blocked.

6.10 Switching to the function manager









The **SEQ** button switches the display to the function manager mode.



Switching to the function manager is only possible while the unit is in standby (output = off). The set values of voltage and current are set to 0V and 0A. For details about the function manager see section „6.15. The function manager“.

6.11 Activating the menu

M The main menu is accessed with the **MENU** button and the display changes to the main menu level. A text menu like this appears:

 Profile	Setting up and selecting user profiles
 Function	Setting up a function sequence
 Analog interface	Settings for the internal analog interface
 Communication	Configure the pluggable interface card
 Options	Default setup, unlock features, lock device configuration
 About...	Manufacturer, service, SW version etc.

ESC A menu page is left to the next higher level by pressing the **ESC** button.



  The **SELECT** keys are used to select another menu entry.

 The **RETURN** button then enters the menu entry into the next sublevel by pressing it. The lowest menu level always shows up as a parameter page. See next topic for details.

6.12 Parameter pages

The parameter page is the lowest menu level. Here you can change many different parameters in order to set up the device.

ESC By pressing the **ESC** button the parameter page is left to the next higher level and no parameters are accepted.

  The **SELECT** keys are used to select a different parameter. The selected parameter is then displayed invertedly and can be changed with the left rotary knob.

 The **RETURN** button submits the changed parameters, which are accepted and stored and used. The parameter page is also exited to the next higher level.

6.13 Alarms, warnings and signals

Alarms, warnings and simple notifications (here called „signals“) can be acoustically signalled or optically in the display. The pins „OT“ or „OVP“ of the built-in analog interface or the optional analog interface card IF-A1 are also reporting overvoltage or overtemperature. Also see section „7.4. Configuring the control panel“.

An alarm has a higher priority than a warning or signal. Up to four alarms, warnings or signals can be displayed, which will cycle in an interval of two seconds. If an alarm occurs, one previous warning or signal will be suppressed if the total number exceeds four.

The output voltage, the output current and the difference between actual and set value can be monitored.

The table below gives an overview of the possible errors and their meanings, as well as the selectable error types, as far as these are configurable.

Indication	Error type			Depending on	Description
	Alarm	Warning	Simple notification		
OV	·				Overvoltage at the power output
SYS	·				General system error
FCT	·				Function could not be saved and/or submitted
OT	·			1)	Overtemperature error
		·		2)	
CAN		·			CAN bus transmission error
U>	def.	def.	def.		Overvoltage supervision threshold exceeded
U<	def.	def.	def.		Undervoltage supervision threshold exceeded
I>	def.	def.	def.		Overcurrent supervision threshold exceeded
I<	def.	def.	def.		Undercurrent supervision threshold exceeded
U↗	def.	def.	def.		Set-actual comparison error at a positive voltage transition
U↘	def.	def.	def.		Set-actual comparison error at a negative voltage transition
I↗	def.	def.	def.		Set-actual comparison error at a positive current transition
I↘	def.	def.	def.		Set-actual comparison error at a negative current transition
P↗	def.	def.	def.		Set-actual comparison error at a positive power transition
P↘	def.	def.	def.		Set-actual comparison error at a negative power transition

1) OT disappear = OFF

2) OT disappear = auto ON

def. = definable

An **alarm** will shut down the output and has to be acknowledged before the output can be switched on again (also see section „6.14. Acknowledging alarms and warnings“).

A **warning** remains in display as long as it is not acknowledged and can temporarily switch off the power output, if „auto ON“ has been activated for a particular error.

A **signal** is only displayed and only as long as the cause of the error is persistent. If more than one signal is notified, they will cycle in the display in a 2s interval.

6.14 Acknowledging alarms and warnings



You can acknowledge alarms and warnings with the **QUIT** button.

If you acknowledge a warning with this button while it still persists, it is turned into a signal and displayed furthermore. Else it is deleted and not displayed anymore.

6.15 The function manager



Note

The function manager is not available as long as the PV feature is enabled (see section 14.3)!

The function manager is used to create functions which can control the unit automatically. The user can build curves of set values after the function $f(U, I, \Delta t)$ with it. The function manager sets the set values in an interval of 2ms. This means, that only times for Δt of a multiple of 2ms can be set, for instance 50ms. If voltage or current changes between two points, a ramp which consists of a certain number of steps ($\Delta t : 2\text{ms}$, results in 25 steps for the example above) is built.

The function manager controls the power supply and puts the set values, which have been configured in the function. The actual progression of the output values is however determined by the load and the output capacity of the device.

Explanation of the used terms:

Function = the function consists of up to 5 linked sequence headers (starts in menu at [Setup function](#)), which can consist of up to five differently configurable sequences.

Function layout = the configurations in the function layout are used by the function manager to set the operation (U/I/P or U/I/R) mode for the power supply. Furthermore, the repetition rate of the function and the arbitrary order of the sequences are set here. In dependency of the function layout the function manager processes the next sequence after the previous one has been processed and uses the settings from the sequence control of the next sequence.

Sequence = consists of the sequence control and 10 sequence points. If the function manager is going to process a sequence, it first of all sets the parameters given in the sequence control. The 10 sequence points are set consecutively and the whole process is repeated as often as the repetition rate for the particular sequence is set to.

Sequence control ([Sequence control](#)) = defines the repetition rate of the sequence and the maximum set value of power during the processing of the sequence, as well as internal resistance (optionally, has to be unlocked).

Sequence point = a sequence always consists of 10 sequence points. The points are processed (=set) consecutively by the function manager from point 0 to point 9. The definition of the sequence point determines, which set values for voltage and current have to be reached after the given time Δt . This enables the user to create step functions by setting the time to 0ms or 2ms, as well as ramps with times from 4ms to 99h99m. A time value of 0ms is settable, but results in a real time value of 2ms, because set values are only set in 2ms steps.

Additionally to the function itself you can set up and use the supervision circuits in the profiles. The function manager can also be controlled via the communication with the interface cards with one additional feature: you can set a stop point at which the function shall stop.

Overview of the function manager display:

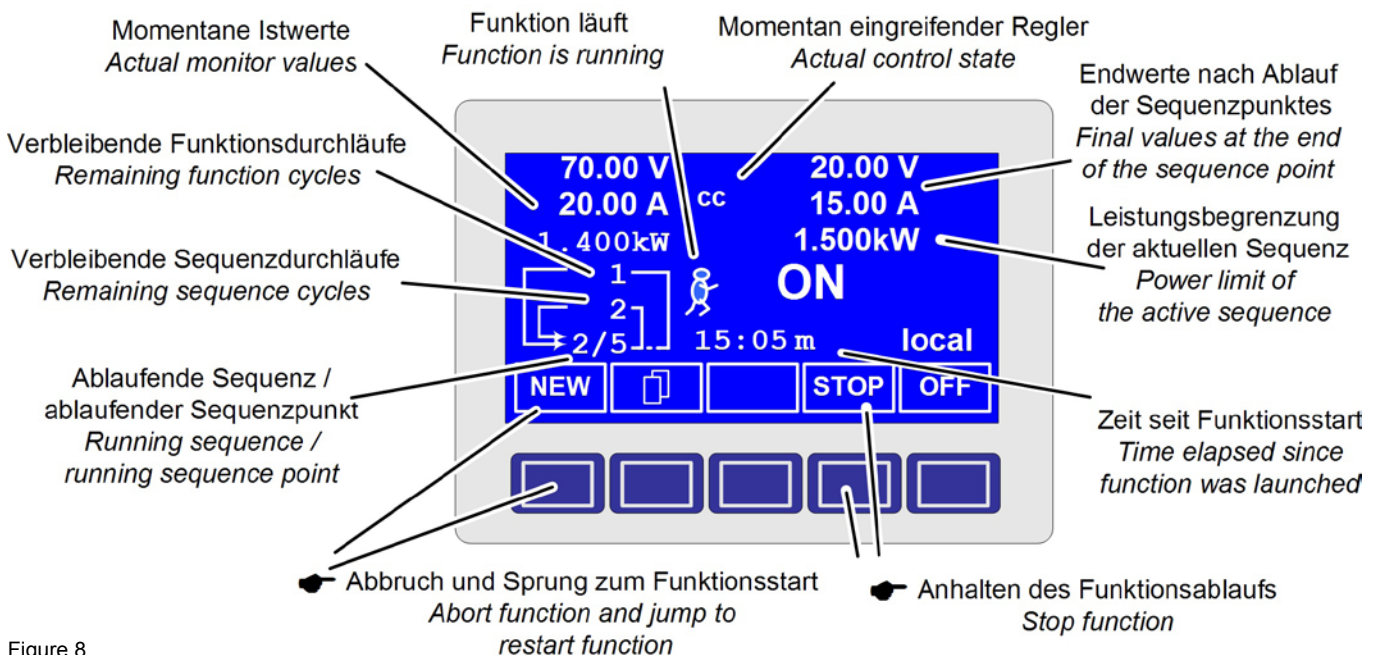

Figure 8

6.15.1 Configuring the function



The menu page **Function** leads to the following menu selection:

- Setup function**
- Sequence 1**
- Sequence 2**
- Sequence 3**
- Sequence 4**
- Sequence 5**

6.15.2 The function layout



You can define the operation mode of the power supply and the repetition rate of the function here.

◆ **Function mode**

- = U//P Function uses U//P operation mode
- = U//R Function uses U//R operation mode (only available if the option „internal resistance“ is unlocked)

Also see section „7.1. Defining operation parameters“)

◆ **Funcct.cycles**

- = {1..254} it is repeated n times
- = ∞ it is repeated infinitely

◆ **Link sequences to one function**

Task: 1 2 3 4 5
Seq.: {-,1..5} {-,1..5} {-,1..5} {-,1..5} {-,1..5}

Beneath the particular tasks you can define of which sequences the function will consist and in which order the sequences are used. The symbol „-“ indicates, that the task is not defined and thus won't be processed.

6.15.3 Configuring sequences

The menu page **Sequence {1..5}** leads to the menu page where the sequences are edited.



It leads to the following menu selection:

- Sequence {1..5}** (number of the sequence to edit)
- Sequence control**
- Sequence points 0-4**
- Sequence points 5-9**

The repetition rate of the sequence, the maximum power and the internal resistance (optional, has to be unlocked) can be configured here, as well as the sequence points.

6.15.4 Sequence related parameters



Function mode : U//P {U//R}

Function mode of the power supply is displayed.

◆ **Seq. cycles** {1..254, ∞} Default: 1
 = {1..254} it will be repeated n times
 = ∞ it will be repeated infinitely

◆ **P seq=** {0...P_{nom}} Default: P_{nom}

The maximum power given here is affecting the whole sequence.

This only with option „internal resistance“ (unlockable):

◆ **R seq=** {0Ω...20 * R_{inom}} Default: R_{nom}

The maximum internal resistance given here is affecting the whole sequence.

6.15.5 Defining the sequence points



A sequence consists of 10 sequence points. A sequence point consists of three values: the set values for U and I together with the time Δt.

◆ **Δt =** { 0...99:59h}

◆ **U[V] =** { 0... U_{nom}}

◆ **I[V] =** { 0... I_{nom}}

In order to understand how sequences are processed you need to consider the start condition of every sequence cycle:

Set values at the start of the function

The function always starts with
 U_{set} = 0V and I_{set} = 0A

Set values at reentrance into the sequence

If the sequence is repeated, the last processed sequence point alters the start condition of the next sequence cycle.

Example: Sequence point 9 is set to the values 80V/50A/250ms and the sequence is repeated, then the sequence starts with 80V and 50A, but with the time that was set for sequence point 0, for instance 500ms. During that 500ms, the set values will approach linearly to the defined values of sequence point 0.

6.15.6 Display during the function run

Also see the overview on the previous page.

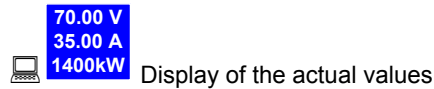

Display of the actual values

On the left side of the display the actual values are shown in small font. The status of the active control (CV/CC/CP) is displayed to the right of the corresponding value.

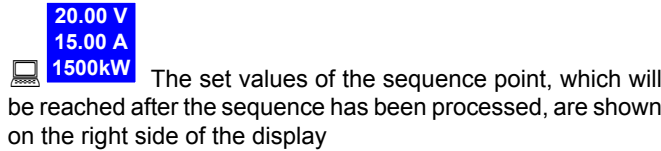

The set values of the sequence point, which will be reached after the sequence has been processed, are shown on the right side of the display

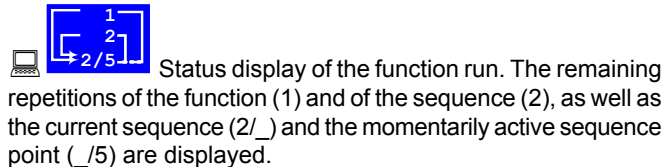

Status display of the function run. The remaining repetitions of the function (1) and of the sequence (2), as well as the current sequence (2/_) and the momentarily active sequence point (_/5) are displayed.

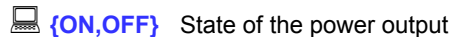
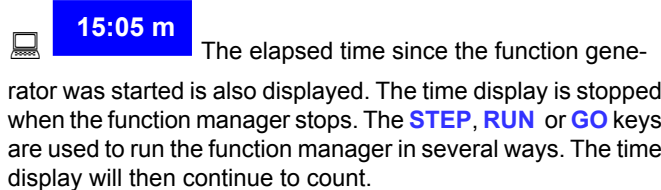
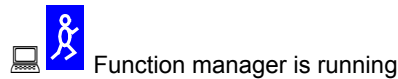
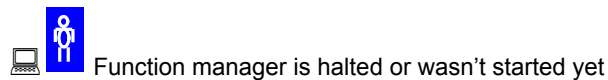

Besides the state of the power output an alarm, a warning or a signal can be displayed.

6.15.7 Controlling the function manager

The interactive control panel provides keys to control the function manager. You can halt, continue, reset it to the starting point or exit the function by using these keys.

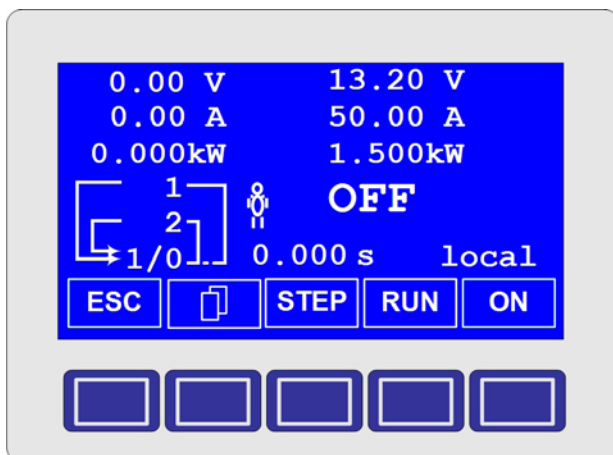

Before the function manager is really setting the power supply you can simulate the function on the display. During this

- the output is not switched on and
- the sequence points are processed step by step and can be verified this way.

The execution is also controllable via communication with an interface card. Here you can additionally set one stop point at one of the 50 sequence points. This sequence point is processed and the sequence/function is then halted.

ESC The **ESC** button exits the function manager and returns to the former state of the power supply.

STEP The **STEP** button is used to run a sequence stepwise. The current sequence point is executed after the button was pressed. After the „step“ has been executed, the set values, which are displayed in upper right corner of the display, are set.

RUN The **RUN** button starts the function manager and the function is run as it was defined. The sequence points are then processed consecutively.

Example for a simulation during standby:

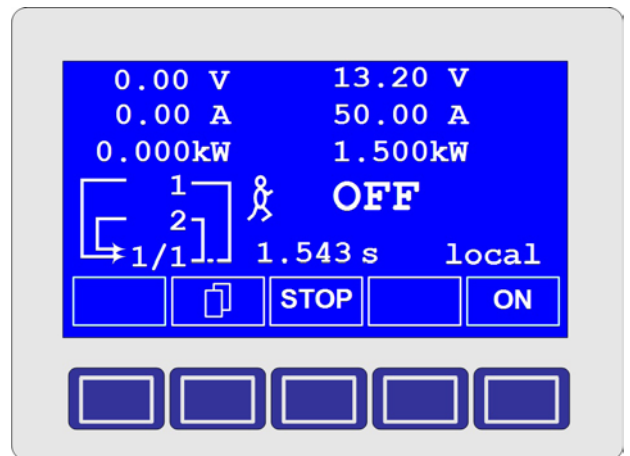

GO Use the **GO** button to continue the function after it was stopped.

NEW Alternatively, you can reset the function manager to the start of the current function with the **NEW** button.

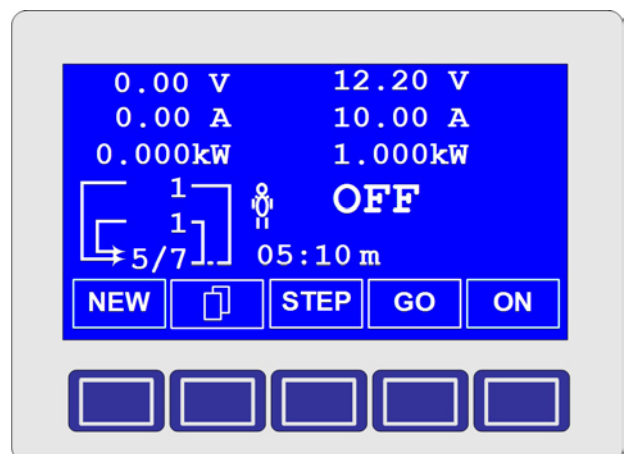

7. Device configuration

Part 1: The menu Profile

Legend:

- Option: Innenwiderstand / Internal resistance
- Nicht bei jedem Modell verfügbar / Not available with every model

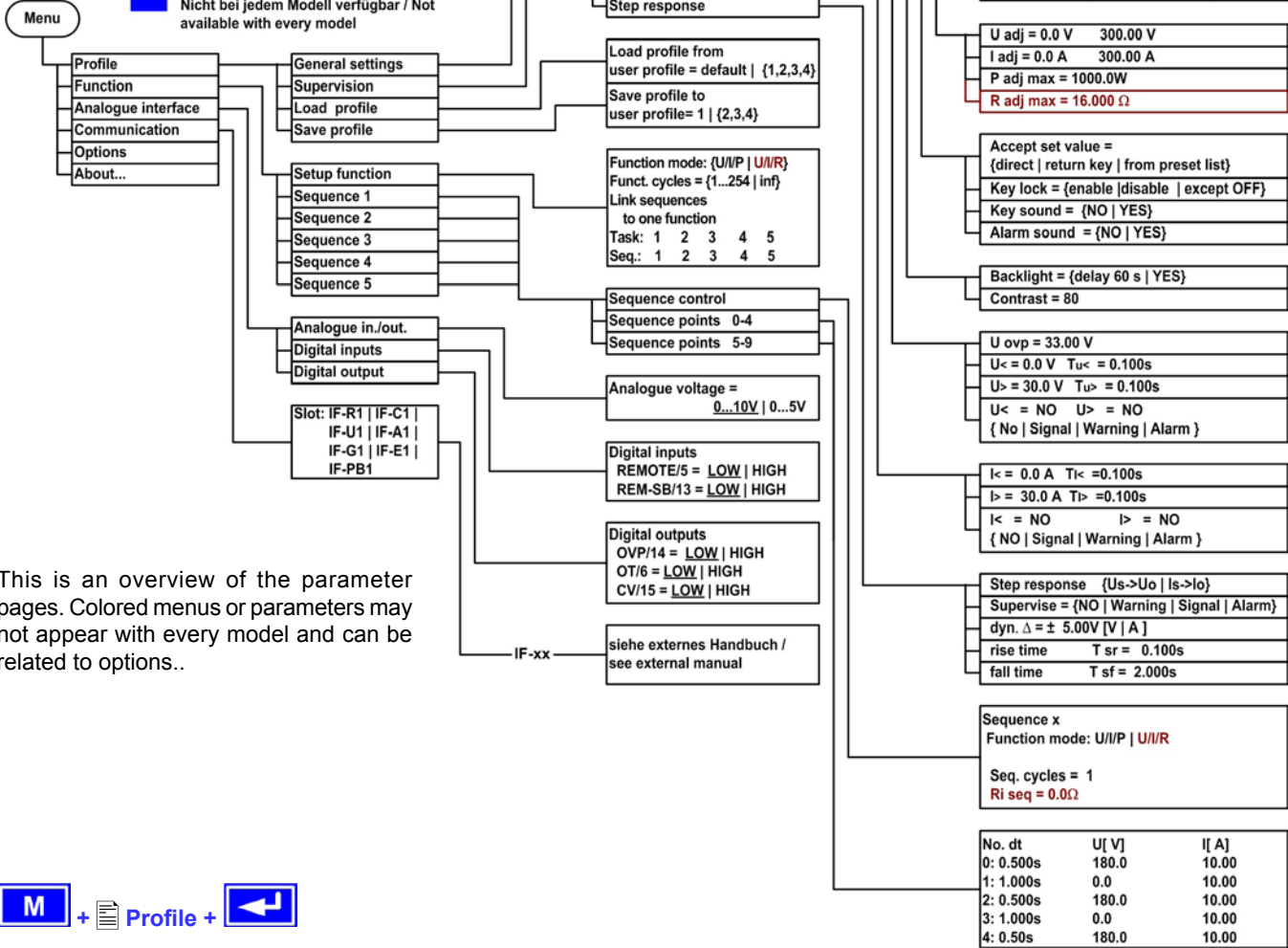





This is an overview of the parameter pages. Colored menus or parameters may not appear with every model and can be related to options..

+ Profile +





The profiles are intended to minimize to time needed to set up the device at alternating users or to keep user defined settings for repeating applications. The last used profile is always loaded after the unit is switched on.

The menu entry  Profile leads you to following selection:

-  [General settings](#)
-  [Supervision](#)
-  [Load profile](#)
-  [Save profile](#)



General settings +

The menu entry  General settings leads to following selection where the operation mode, the display itself and the handling (adjustment) of the unit can be configured:

-  [Setup operation mode](#)
-  [Preset list](#)
-  [Adjust limits](#)
-  [Control panel](#)
-  [Display](#)

Supervision +

The menu entry  Supervision leads to following selection where alarms, warnings and signals, as well as the corresponding supervision limits and reaction times are set up.

-  [U thresholds](#)
-  [I thresholds](#)
-  [Step response](#)

Load profile +

◆ [Load profile from user profile = {default, 1..4}](#)

The current profil is replaced by the selected one.

Save profile +

◆ [Save profile to user profile = {1..4}](#)

The current profile can be stored into one out of four profiles.

7.1 Defining operation parameters

Setup operation mode +

The way of adjusting the set values, which operation mode is used, how the unit shall react after the mains has restored or the behaviour of the unit after an overtemperature error can be configured here.

U//P or U//R operation mode

◆ Setup op. mode Default: U//P

= U//P The power stage is controlled by voltage, current and power set values

= U//R The power stage is controlled by voltage, current and resistance set values and a settable, but not adjustable power set value (only with unlocked option „internal resistance control“). The U//R operation mode can only be used after it has been unlocked in the  Options menu.

Reactivation after an overtemperature error

◆ Output on OT Default: auto ON

= OFF The power supply output remains switched off, even if the unit has already cooled down.

The error  OT (overtemperature) is displayed as an alarm.

= auto ON The power supply is automatically switched on after the unit has cooled down below the overtemperature shutdown limit. The error

 OT (overtemperature) is then displayed as a warning.

= ON The power supply output remains on and will provide voltage as long as at least one of the power stages keeps working.

Warnings as well as alarms are only deleted from the display after they have been acknowledged (see also „6.13. Alarms, warnings and signals“).

Output state after „power on“

◆ Power ON Default: restore

= OFF The power supply output remains switched off after the mains voltage returns or after the unit was switched on.

= restore The power supply output is set to the state it had before a mains voltage loss occurred or before the unit was switched off. In case it was ON when the unit was switched off, it will also be ON when the unit is switched on again.

7.2 Predefining preset lists

Preset List +

You can predefine up to four different presets.

No.	U[V]	I[A]	P[kW]	R[Ω]*
1:	0.00	0.00	1.500	200
2:	10.00	10.00	1.200	250
-:	0.00	0.00	1.500	500
-:	0.00	0.00	1.500	800

* Resistance values (red) only with unlocked option U//R. The unit changes, depending on the model, between Ω and kΩ.

With the parameter ◆ **Accept set value = from preset list** you can switch from the normal set values (eg. adjusted by the rotary knob) to one of the predefined sets or switch between predefined sets. You can actually „jump“ between set values with this option.

7.3 Adjustment limits

Note

All the below described limits only affect the normal set values and not set values that can be edited for sequences in the function manager

Adjust limits +

The maximum and minimum adjustment limits can be defined here. These limits are always interfering, in **local** or **remote** mode, i.e. unit is controlled by a PC.

Limits of the set value of voltage

◆ U adj Default: 0V, U_{nom}

= {U_{adj.min}} {U_{adj.max}}

Whereas U_{adj.min} = {0...U_{adj.max}} and U_{adj.max} = {U_{adj.min}...U_{nenn}}

You can define the lower and upper limit of the adjustable voltage here. Set values which exceed these limits are not accepted, neither from the control panel nor from the remote control via a PC (communication with interface cards).

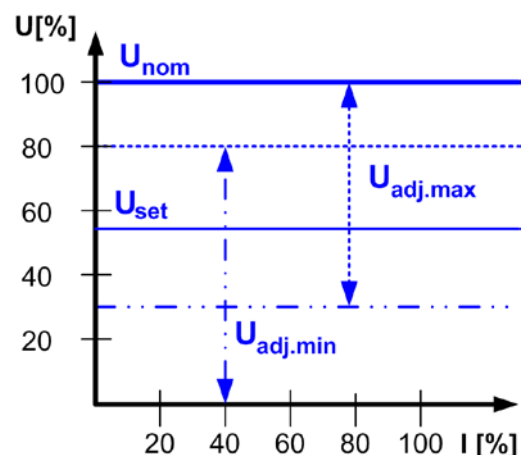

Limits of the set value of current

◆ **I adj** Default: 0A, I_{nom}

$$= \{I_{adj,min}\} \{I_{adj,max}\}$$

Whereas $I_{adj,min} = \{0 \dots I_{adj,max}\}$ and $I_{adj,max} = \{I_{adj,min} \dots I_{nom}\}$

You can define the lower and upper limit of the adjustable current here. Set values which exceed these limits are not accepted, neither from the control panel nor from the remote control via a PC (communication with interface cards).

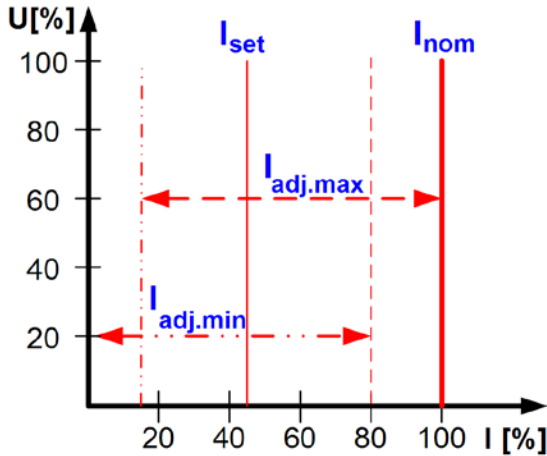

Limit of the set value of power

◆ **P adj max** Default: P_{nom}

$$= \{0kW \dots P_{nom}\}$$

You can define the upper limit of the maximum adjustable power here. Set values which exceed these limits are not accepted, neither from the control panel nor from the remote control via a PC (communication with interface cards).

Limit of the set value of internal resistance

(Optional, only accessible with unlocked U//R mode)

◆ **R adj max** Default: 0Ω

$$= \{0\Omega \dots 20 * R_{i,nom}\}$$

If the U//R mode has been unlocked, you can set the upper limit of the maximum adjustable internal resistance. Set values which exceed these limits are not accepted, neither from the control panel nor from the remote control via a PC (communication with interface cards).

7.4 Configuring the control panel

Control panel + 

The menu page  **Control panel** lets you configure all parameters that are related to the graphical display and the control panel.

Configure how set values are manually adjusted

◆ **Accept set value** Default: *direct*



= *direct*

The set values are directly submitted to the power stage when changed with the rotary knobs

= *return key*

The changed set values are only set if submitted with the  button.

= *from preset list*

You can choose sets from the  **Preset List** with the rotary knobs and submit them with the  button

Control panel lock

The control panel lock is only configured here.

◆ **Key lock** Default: *except OFF*

= *except OFF*

The control panel (buttons and rotary knobs) will be locked, except for the **OFF** button

= *enable*

The rotary knobs and most buttons will be locked

= *disable*

No lock

The control panel lock is used to prevent from unwanted changes to the set values or to the settings.

 **Note**

This setting is only temporary. It is reset (=disable) after the device is switched on again or returns from mains blackout.

Sounds

◆ **Key sound** Default: *NO*

= *YES*

A short beep signals a button press

= *NO*

No signal if keys are pressed

◆ **Alarm sound** Default: *YES*

= *YES*

If an alarm or warning occurs an acoustic signal is emitted (beep) in short intervals

= *NO*

No acoustic signal for alarms/warnings

7.5 Configuring the graphic display

Display +

The menu page  **Display** lets you configure all parameters related to the graphic display.

◆ Backlight

Default: YES

= YES

The backlight is permanently on

= delay 60s

The backlight will be switched off with a delay of 60s after a button or a rotary knob has been used the last time

◆ Contrast

Default: 70

= { 40...100 }

The contrast can be adjusted to suit the needs of the location where the unit is installed and for a clearer view at the values.

7.6 Supervision

Supervision +

The **Supervision** menu lets you configure the supervision of output voltage, output current and output power. You can also supervise a step function. The menu  **Supervision** leads you to following menu selection:

U thresholds

I thresholds

Step response

7.6.1 Voltage supervision

U thresholds +

The menu page  **U thresholds** lets you configure the overvoltage threshold (OVP) as well as the supervision circuits for over- and undervoltage.

Overvoltage protection (OVP)

◆ U ovp

Default: $1,1 \cdot U_{nom}$

= { $U > \dots 1,1 \cdot U_{nom}$ }

The overvoltage protection is intended to protect the connected load. This threshold should always be adjusted to the maximum voltage the load can take without damage. The output is instantly shut down if this threshold is exceeded.

Example: a 1000V unit can be adjusted up to 1100V for U_{ovp}



OV It is displayed as an alarm.

(also see „6.13. Alarms, warnings and signals“)

Overvoltage supervision

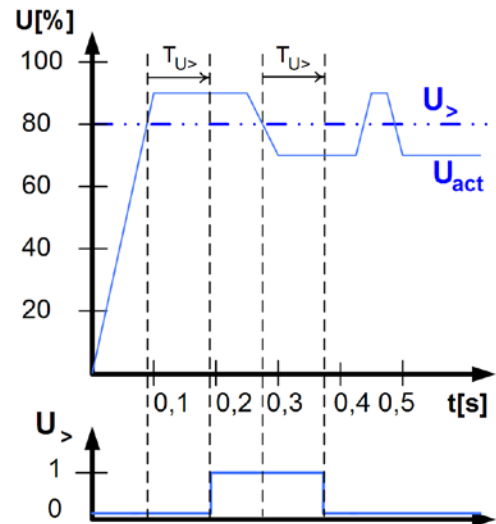

◆ U>

Default: U_{Nom}

= { $U < \dots U_{ovp}$ }

◆ Tu>

Default: 100ms

= { 0...99:59h }

This is slightly different from the OVP (see above). Here the voltage is also supervised, but it is notified with either an alarm, a warning or a signal and after a definable delay $\blacklozenge Tu>$. The signal vanishes if the voltage is under the threshold for the time $\blacklozenge Tu>$. Hence you can supervise overvoltages without getting an OVP error every time or if you only want to get an alarm if the overvoltage is persistent longer than defined by $\blacklozenge Tu>$.



U> Alarm: Overvoltage

This error shuts down the power output. An alarm has to be acknowledged, before the power output can be switched on again.



U> Warning: Overvoltage

The error is notified and remains until it is acknowledged and not persistent anymore.



U> Signal: Overvoltage

Undervoltage supervision

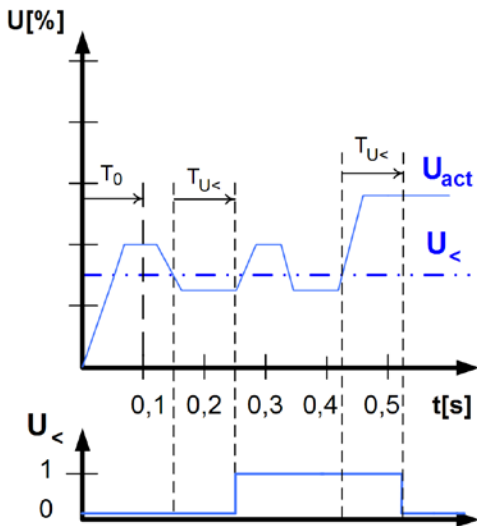

◆ **U<** Default: 0V
= { 0... U>}

◆ **Tu<** Default: 100ms
= { 0...99:59h}

As soon as the voltage falls below the undervoltage threshold, the undervoltage is notified after the response time ◆ **Tu<**. The notification vanishes, if the undervoltage limit is exceeded for the time ◆ **Tu<**. This undervoltage error is suppressed for $T_0=100\text{ms}$ after the power output was switched on.

 **U<** Alarm: Undervoltage

This error shuts down the power output. An alarm has to be acknowledged, before the power output can be switched on again.

 **U<** Warning: Undervoltage

The error is notified and remains until it is acknowledged and not persistent anymore.

 **U<** Signal: Undervoltage

The analog interface (IF-A1, optional) can signalise an undervoltage at one of the digital outputs.

7.6.2 Current supervision

 **I thresholds +** 

The menu page  **I thresholds** lets you configure the supervision circuits for under- and overcurrent.

Undercurrent supervision

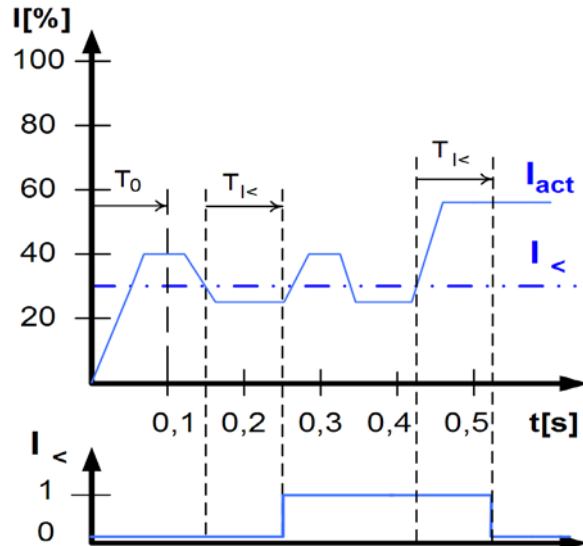

◆ **I<** Default: 0A
= { 0... I>}

◆ **Ti<** Default: 100ms
= { 0...99:59h}

The undercurrent error is signalled after the response time ◆ **Ti<**, if the actual value of the current falls below the adjusted undercurrent limit. The error notification vanishes if the actual current has exceeded the threshold again for the time ◆ **Ti<**. This undercurrent error is suppressed for $T_0=100\text{ms}$ after the power output was switched on.

 **I<** Alarm: Undercurrent

This error shuts down the power output. An alarm has to be acknowledged, before the power output can be switched on again.

 **I<** Warning: Undercurrent

The error is notified and remains until it is acknowledged and not persistent anymore.

 **I<** Signal: Undercurrent

Overcurrent supervision

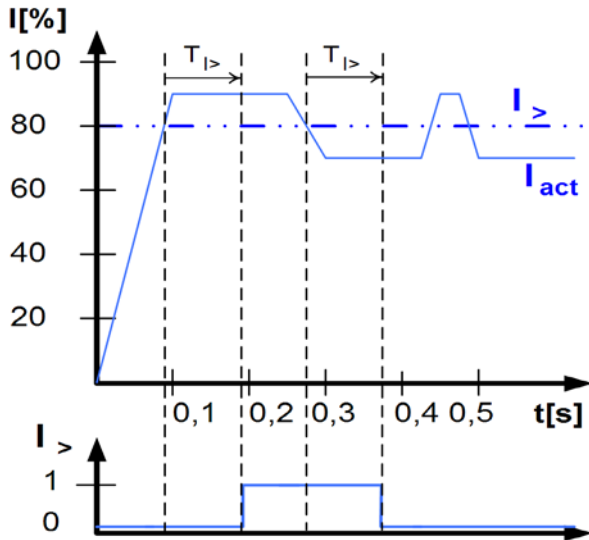

◆ $I_>$ Default: I_{nom}
 = { $I_{<... I_{nom}$ }

◆ $T_{I>}$ Default: 100ms
 = { 0...99:59h }

The overcurrent error is signalled after the response time

◆ $T_{I>}$, if the actual value of the current falls below the adjusted overcurrent limit. The error notification vanishes if the actual current has exceeded the threshold again for the time ◆ $T_{I>}$. This overcurrent error is suppressed for $T_0 = 100ms$ after the output was switched on.

🖥️ Alarm: Overcurrent

This error shuts down the power output. An alarm has to be acknowledged, before the power output can be switched on again.

🖥️ Warning: Overcurrent

The error is notified and remains until it is acknowledged and not persistent anymore.

🖥️ $I_>$ Signal: Overcurrent

The analog interface (IF-A1, optional) can signalise an overcurrent or undercurrent at one of the digital outputs.

7.6.3 Step response supervision

📄 Step response +

The menu page 📄 Step response lets you configure the supervision circuits for the dynamic and static comparison of actual value and set value.

◆ Step response Default: $U_s \rightarrow U_o$
 $U_s \rightarrow U_o$ Supervision of the deviance between set value and actual value of voltage
 $I_s \rightarrow I_o$ Supervision of the deviance between set value and actual value of current

◆ Supervise Default: NO
 NO Supervision is inactive
 Signal Supervision reports a signal
 Warning Supervision reports a warning
 Alarm Supervision reports an alarm

◆ dyn. Δ Default: 10% I_{nom} resp. U_{nom}
 = $\pm \{0...1, 1 * U_{nom}\}$ Allowed tolerance for the voltage
 = $\pm \{0...I_{nom}\}$ Allowed tolerance for the current

Note: The settling process of the power supply is determined by the load. After a set value has changed, a certain time elapses until the desired value is put to the power output. For instance, it can last some seconds for the voltage to go down from 100% to 0V at no or small load, because the output capacitors need a time to discharge.

Supervision of a step response

The adjusted set value is compared with the measured actual value. If there is a difference between them and this difference is greater than the tolerance, the supervision will initiate an error after the settling time ◆ T_{sr} . See figure below.

◆ rise time
 $T_{sr} = \{0...99:59h\}$ Default: 100ms

◆ fall time
 $T_{sf} = \{0...99:59h\}$ Default: 2s

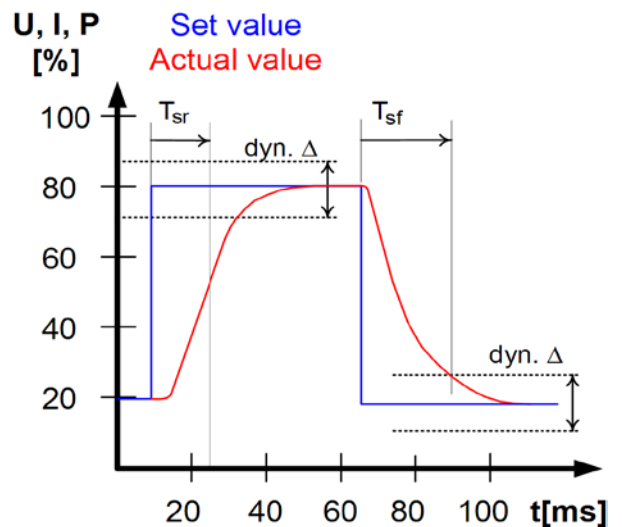

Notifications of the set/actual comparison

Example: The step from a lower set value to a higher set value was not performed within the settling time \blacklozenge T_{sr} . The supervision error is then notified as alarm, warning or signal.



Depending on the configuration of Step response, notifications for the current (I) are alternatively displayed.

Example: The step from a higher set value to a lower set value was not performed within the settling time \blacklozenge T_{sf} . The supervision error is then notified as alarm, warning or signal.



Depending on the configuration of Step response, notifications for the current (I) are alternatively displayed.

Part 2: The menu **Options**

The menu entry



leads you to following menu selection:

- Reset configuration**
- Enable PV mode**
- Enable R mode**
- Setup lock**

7.7 Reset to default configuration

You can reset all modifications of the setup to the default setup (the state the unit had when it was delivered).

After selecting the corresponding menu entry you will be prompted again to submit the choice to reset your current, personal configuration.

Attention!
Even if the device configuration has been locked by a PIN it will be unlocked and reset with this action!



\blacklozenge **Are you sure ?** Default: NO
 = YES All modifications of the default setup are reset
 = NO No change

7.8 Activating the photovoltaics feature



\blacklozenge **PV mode = {enabled | disabled}**

With setting **enabled**, the hardware and software functionality of the photovoltaics feature is enabled. This setting is permanent until altered. Active PV functionality is indicated in the main display with text **PV** left to the power set value. About the principle of the solar panel simulation of the PV feature see section „11. PV - Solar panel simulation“.

Note
Activation of operation mode U/I/R will automatically reset PV mode to disabled. As long as U/I/R is activated, the PV feature can not be enabled. Also see „7.1. Defining operation parameters“.

7.9 Unlocking the U/I/R mode

The U/I/R operation mode can only be used after it was unlocked with a PIN code in menu **Options** (also see section „14.3. Option: Internal resistance“):



\blacklozenge **Activate R mode via pin code:**

The code to use here is not for free and can be obtained from your device supplier. After it has been unlocked, the status can be verified in the menu **Options**:

R mode available:

YES The U/I/R operation mode is unlocked and can be used
 NO U/I/R mode not enabled yet

Before the U/I/R mode can be used, it has to be activated in the profile (see „7.1. Defining operation parameters“). The resistance set value then becomes adjustable in the main operation display and goes from 0Ω up to R_{Nom} , which is defined as $20 * U_{Nom} \div I_{Nom}$.

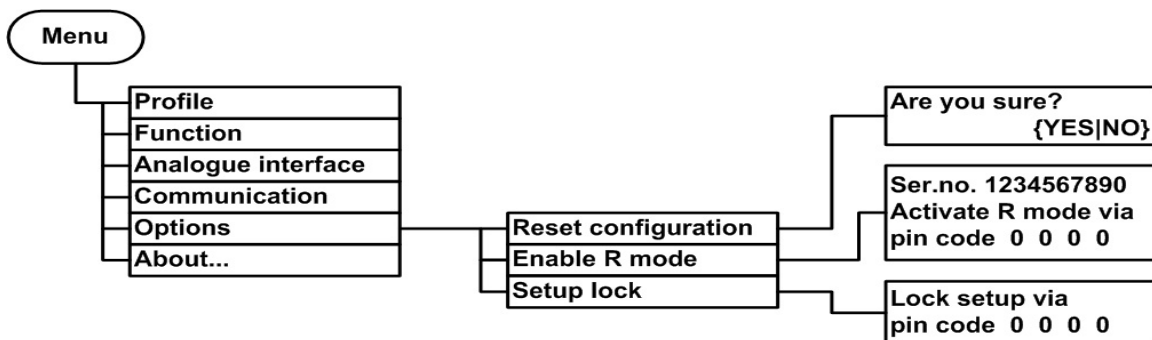

7.10 Locking the device configuration



It can be necessary, for security reasons, to lock the device configuration from access. You can enter a PIN code here, consisting of 4 numbers, each from 0 to 15.

◆ **Lock setup via pin code:** Enter the PIN code {0..15} {0..15} {0..15} {0..15}

The lock can only be disabled with the same PIN code or by resetting the configuration with **Reset configuration**. This will reset the configuration to factory setting. It also deletes the custom setup and can be used in case the PIN code for setup lock has been lost.



Attention!

This only affects the user profile of the device, not the set values or the rotary knobs on the front panel!

8. Special characteristics

8.1 Switching on by power switch

The power switch is located at the front. After switching on, the device will show some information in the display: manufacturer's name, address and logo, device type and firmware version. In the device setup (see section „7. Device configuration“) there is an option „Power On“ that determines the output condition after the device is switched on. Default is „OFF“. It means, that the set values of U, I, P and the output condition are not restored to what was present when the device was switched off the last time. In case the option is set to „OFF“, the set values of U and I are set to 0, the set value of P to 100% and the output is switched on after every start. With setting „restore“, the set values and the output condition will be restored when switching the unit on.

8.2 Switching off by power switch

Switching the device off by power switch is handled as mains blackout. The device will save the last set values and output condition. After a short time, power output and fans will be switched off and after a few seconds more, the device will be completely off.

8.3 Switching to remote control

a) **Built-in analog interface:** Pin 5 „Remote“ switches the device to remote control via the set values pins VSEL (pin 1), CSEL (pin 2) and PSEL (pin 8), as well as the status input REM-SB (pin 13), if not inhibited by **local** mode or **remote** control by digital interface already being active. The output condition and the set values which are put into pins 1, 2, 8 and 13 (also see section „10. Internal analog interface“) are immediately set. After return from remote control, the output will be switched off and the last, remotely adjusted set values of U, I and P are kept.

b) **Optional, analog interface IF-A1:** Pin 22 „SEL-enable“ switches the device to remote control via the set values pins VSEL (pin 3), CSEL (pin 2) and PSEL (pin 1), as well as the status input REM-SB (pin 23), if not inhibited by **local** mode or remote control by digital interface already being active. The output condition and the set values which are put into pins 1, 2, 3 and 23 (also see section „10. Internal analog interface“) are immediately set. After return from remote control, the output will be switched off and the last, remotely adjusted set values of U, I and P are kept.



Note

There are settings for the optional analog interface in the device setup, regarding the logical levels of the digital pins etc., which are described in the external interface cards manual. The examples as depicted in section 10.4 can also be used for 25pole analog connector of the IF-A1, but the pin numbers and some pin names differ.

c) **Optional, digital interface:** Switching to remote control by the corresponding command (here: object), if not inhibited by **local** mode or remote control via an analog interface already being active, keeps output state and set values until altered.

8.4 Overvoltage alarm

An overvoltage error can occur due to an internal defect (output voltage rises uncontrolledly) or by a too high voltage from external. The overvoltage protection (OVP) will switch off the output and indicate the error on the display by the status text „OV“ and an alarm symbol and on the pin 14 „OVP“ of the built-in analog interface and on pin 8 „OVP“ of the optional, analog interface IF-A1, if equipped.

External voltages higher than 120% nominal voltage at the output must be avoided, or else internal components of the device might be destroyed!

If the cause of the overvoltage is removed, the output can be switched on again and status text „OV“ will disappear. Before this, the alarm has to be acknowledged by button or by a command via digital interface. If the error is still present, the output is not switched on.

OV errors are recorded as alarm into the internal alarm buffer. This buffer can be read out via a digital interface. Flushing the buffer is initiated by another command.

8.5 Overtemperature

As soon as an overtemperature (OT) error occurs by internal overheating of one or multiple power stages, the status is indicated in the display by a text „OT“ and an alarm symbol and on the pin 6 „OT“ of the built-in analog interface, as well as on pin 9 „OT“ of the optional, analog interface IF-A1, if equipped. The output is not always switched off, depending on the settings (see „7.1. Defining operation parameters“), and continues to provide voltage. The output voltage only will only be zero if all internal power stages (10kW models = 2 stages, 15kW models = 3 stages) have shut down because of overheat.

OT errors have to be acknowledged with pushbutton or by sending the corresponding command via an optional, digital interface. They're recorded as alarm into the internal alarm buffer. This buffer can be read out via the digital interface. Flushing the buffer is initiated by another command.

8.6 Voltage, current and power are regulated

The output voltage of the power supply and the resistance of the load determine the output current. If this current is lower than the current limitation set by the current set value, then the device is working in constant voltage (CV) regulation, indicated by the status text „CV“.

If the output current is limited by the current set value or by the nominal current, the device will change to constant current (CC) regulation mode, indicated by the status text „CC“.

All models feature an adjustable power limitation for $0 \dots P_{Nom}$. It becomes active and overrides constant voltage or constant current regulation mode, if the product of actual current and actual voltage exceeds the adjusted power limitation. The power limitation primarily affects the output voltage. Because voltage, current and power limitation affect each other, various situations like these may occur:

Example 1: the device is in constant voltage regulation, then the power is limited down. As a result, the output voltage is decreased. A lower output voltage results in a lower output current. In case the resistance of the load is then decreased, the output current will rise again and the output voltage will sink further.

Example 2: the device is in constant current regulation, the output voltage is defined by the resistance of the load. Then the power is limited down. Output voltage and current are decreasing to values according to the formula $P = U \cdot I$. Once the current set value is decreased, the output current would also decrease and thus the output voltage.

The product of both values, the actual power, would sink below the previously set power limit and the device would change from constant power regulation (CP) to constant current regulation (CC).

Those three conditions CC, CV and CP are also indicated on the appropriate pins of the optional, analog interface cards or can be read out as status bits via an optional, digital interface card.

8.7 Remote sense is active

Remote sense operation is used to compensate voltage drops of the conductors between the power supply and the load. Because the compensation is limited to a certain level, it is recommended to match the cross section of the conductors to the output current and thus minimise the voltage drop.

The sense input is located on the rear at terminal **Sense**, where the sense conductors are connected to the load with correct polarity. The power supply will detect the external sense automatically and compensate the output voltage by the actual voltage at the load instead of the output. The output voltage will be raised by the value of the voltage drop between power supply and load.

Maximum compensation: see technical specifications, will vary from model to model.

Also see figure 9 below.

8.8 Mains undervoltage or overvoltage occurs

The units require two or three phases of a three-phase supply with 400V phase conductor voltage and tolerate max. $\pm 15\%$. This results in an input voltage range of 340...460V AC. Within this range, the units can be operated without any restrictions. Input voltages below 340V AC are considered as supply undervoltage and will store the last condition, as well as switch the power output off. Same happens at overvoltage above 460V AC.

	Attention!
Permanent input undervoltage or overvoltage must be avoided!	

8.9 Connecting different types of loads

Different types of loads, such as ohmic loads (lamp, resistor), electronic loads or inductive loads (motor) behave differently and can retroact to the power supply. For example, motors can induce a countervoltage which may cause the overvoltage protection of the power supply to shut off the output.

Electronic loads have regulator circuits for voltage, current and power that can counteract to the ones of the power supply and may result in increased output ripple or other, unwanted side effects. Ohmic loads are almost 100% neutral. It is recommended to consider the load situation when planning applications.

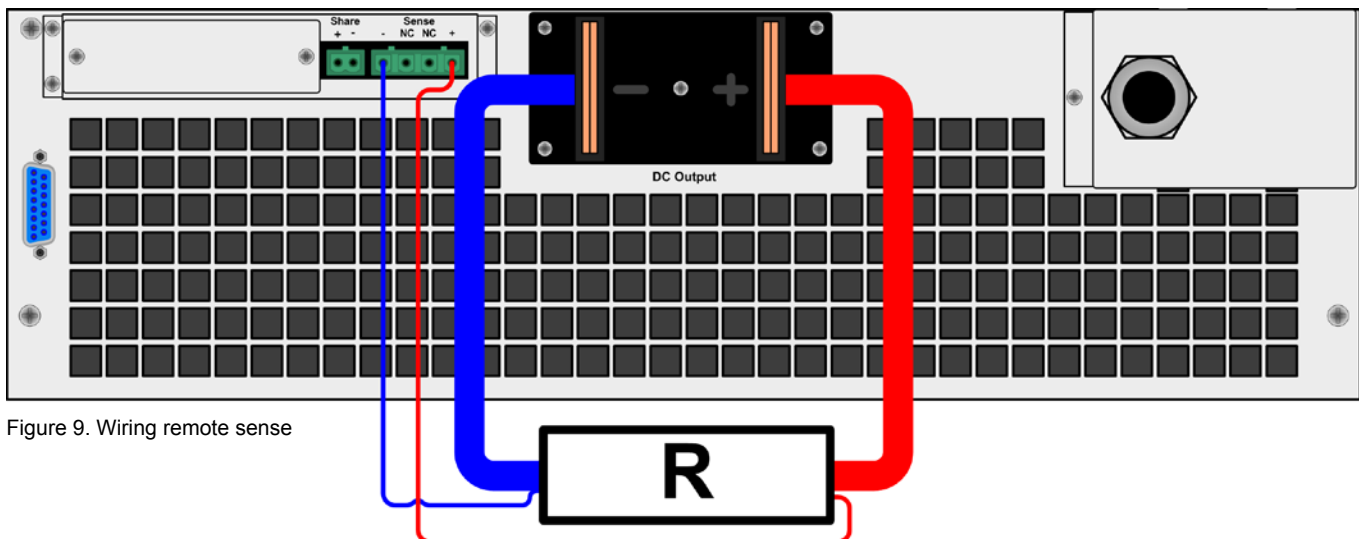

Figure 9. Wiring remote sense

9. Digital interfaces

9.1 General

The power supply supports various optionally available interface cards for digital or analog remote control. All cards are galvanically isolated. Following isolation voltages are given:

- USB (IF-U1), CAN (IF-C1), RS232 (IF-R1): 2000V DC
- GPIB (IF-G1): 2000V DC
- Ethernet (IF-E1b): 1500V DC
- Extended analog interface (IF-A1): 2000V DC

Note

Before picking an interface for remote control, consider the isolation voltage and carefully check if the particular isolation voltage is sufficient for the target application!

The digital interface cards IF-R1 (RS232), IF-C1(CAN) and IF-U1(USB) use a uniform communication protocol. Up to 30 units can be controlled from a PC at once with these cards.

The GPIB interface IF-G1 (IEEE 488) offers a SCPI command structure for up to 15 units per bus.

The Ethernet/LAN interface IF-E1 also provides SCPI command set, as well as a browser surface. It features an additional USB port which makes the device accessible like with the IF-U1 card.

The interface card IF-A1 is an extended analog interface, which features a higher isolation voltage than the built-in analog interface, as well as variable input voltage range and much more. For more information, please refer to the interface cards operating guide, which is supplied on the CD that is included with the interface or available upon request or on our website.

9.2 Configuring the interface card

If there is interface card equipped, the device will detect it automatically. The device displays the card with its product code and article number. Settings can be accessed via the menu



Except for the analog interface card IF-A1 and the Ethernet card IF-E1B it is necessary to set the unit's address when using a digital interface card. Only then the unit can be identified correctly:

Slot: { IF-... } depends on what is equipped

Device node

Default: 1

= {1..30}

Up to 30 device nodes (addresses) can be assigned to devices, one per unit. A device node must only be assigned once if multiple units are controlled.

Configuring the various cards

All cards have different parameters to configure. These are explained in detail in the corresponding operating guide. Please refer to it.

10. Internal analog interface

10.1 General

The integrated, galvanically isolated (for isolation voltage see „2. Technical specifications“), 15 pole analog interface is located on the rear and offers following possibilities:

- Remote control of output current, voltage and power
- Remote monitoring of status (OT, OVP, CC, CV)
- Remote monitoring of actual values
- Remotely switching the output on/off

The set value inputs can be operated with either 0...5V or 0...10V. The desired voltage range is selected in the device setup (see section 10.3).

Usage instructions:

- Controlling the device with analog voltages requires to switch it to remote control with pin „REMOTE“ (5).
- Before connecting the application that is used to control the power supply, make sure to wire all cables correctly and check if the application is unable to put in voltages higher than specified (max. 12V).
- The input REM-SB (remote standby, pin 13) overrides the pushbutton **ON**. It means, the output can not be switched on by the button if the pin defines the output state as „off“. This does not apply, if the control location was set to **local**. Also see section 6.9.
- Putting in set values up to 10V while the 0...5V range is selected will ignore any voltage above 5V (clipping) and keep the output value at 100%.
- Remote control is not possible if the user has switched the device to U/I/R mode on a model where internal resistance control is unlocked. The internal resistance set value can not be controlled by analog interface!
- **The whole interface is galvanically isolated against the DC output of the device.**

10.2 Overview D-Sub socket

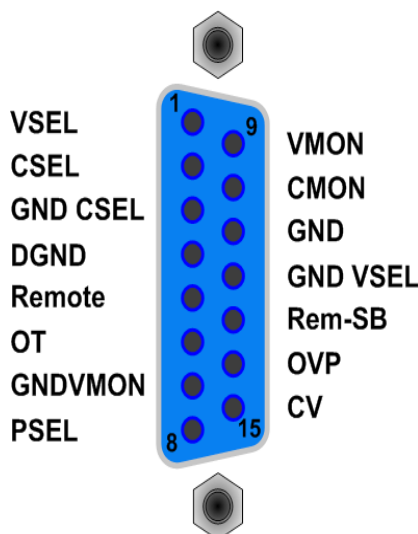

10.3 Settings in the device setup



The setup menu gives access to some settings for the built-in analog interface:

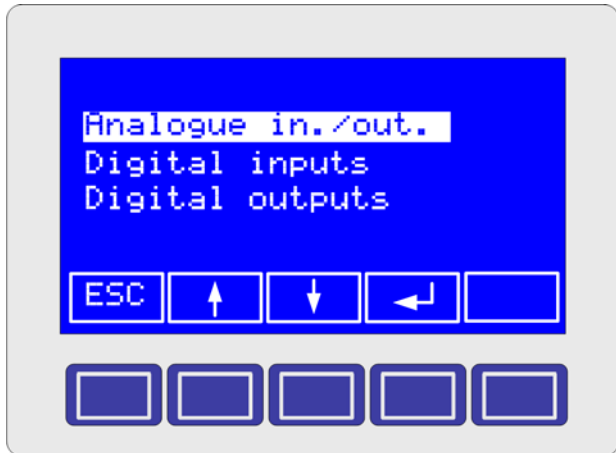

- ◆ **Analog voltage** Default: 0...10V
 - = 0...10V Selects 0...10V for 0...100% set/actual values.
 - = 0...5V Selects 0...5V for 0...100% set/actual values.

The reference voltage at pin VREF is automatically adjusted to the above selection and will be either 5V or 10V.

- ◆ **REMOTE /5** Default: LOW
 - = LOW Unit switches to analog remote control, if the pin is pulled to LOW (ground).
 - = HIGH Unit switches to analog remote control, if the pin is pulled to HIGH or left open.

Attention!

The pin is tied to HIGH level by default. It means, if setting HIGH is selected and the pin is left open, the device will permanently be in analog remote control, unless local is activated.

- ◆ **REM-SB /13** Default: LOW
 - = LOW Unit switches the DC output off, if the pin is tied to LOW (ground).
 - = HIGH Unit switches the DC output on again, if the pin is tied to HIGH.

Attention!

The pin is tied to HIGH level by default. It means, if setting HIGH is selected and the pin is left open, the DC output would be permanently switched off, unless local is activated.

- ◆ **OVP /14** Default: LOW
- ◆ **OT /6** Default: LOW
- ◆ **CV /15** Default: LOW
 - = { LOW | HIGH } Defines, if the digital outputs will report their dedicated status with either LOW or HIGH level.

10.4 Example applications

Attention!

Never connect any ground of the analog interface to minus (negative) or plus (positive) output of the device! This will eliminate the galvanic isolation and possibly put dangerous potential to the analog interface and thus also to the control application (eg. a PLC), especially when operating the DC output on transformerless inverters.

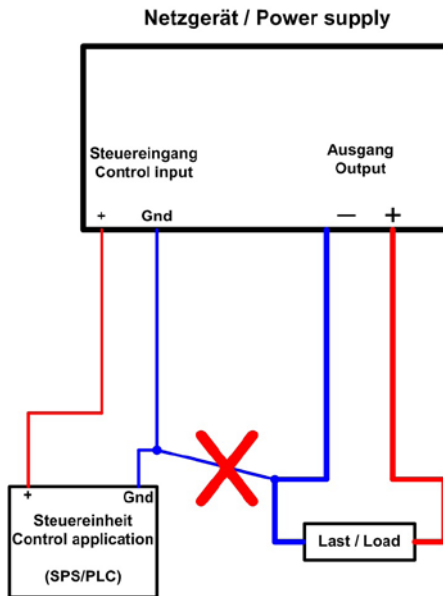
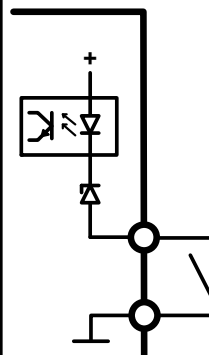

Figure 10

Note

A digital output of a PLC or any other controlling application may not be able to pull inputs like REMOTE or REM-SB to LOW. Refer to the technical specifications of the particular hardware for details.

Principle view of input REM-SB and REMOTE:



Output off/on

Pin 13 „REM-SB“ is always operative and does not depend on the remote mode . It can thus be used to switch off the output without extra means, except the device was set to mode **local**. Then the pin has no function. Switching the output off is done by connecting the pin to ground (DGND) via a low-resistive contact like a switch, open collector transistor or relay, if setting „LOW“ was selected for the pin REM-SB (see section 10.3). If HIGH is set, it is vice versa and the contact has to be opened in order to shut the output down (emergency off principle).

Note

A digital output of, for example, a PLC may not be able to perform the action correctly, because it might not be low-resistive enough. Always check the technical specifications of your external control application.

Wiring example:

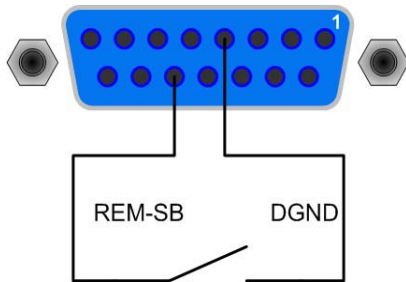

Activate remote control

Switching to remote control is required as soon as the device is going to be controlled with external set values.

Remote control is active as long as pin REMOTE is given the corresponding level and remote control is not interrupted by **local** mode.

Remote control active: REMOTE = LOW | HIGH

Remote control inactive: REMOTE = HIGH | LOW

With this series, the level to switch the device to remote control depends on the setting LOW or HIGH, given for this pin in the device setup.

Wiring example:

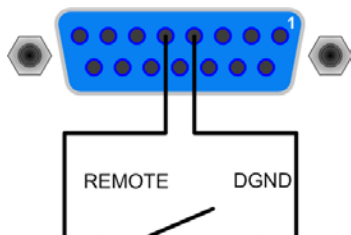

Attention!

The pin is tied to HIGH level by default. It means, if setting **HIGH** is selected and the pin is left open, the DC output would be permanently switched off, unless **local** is activated.

Attention!

When switching to analog remote control while the DC output is on, the output voltage might instantly rise to dangerous levels, depending on the given set values on the analog interface!

Remote control of set values

The inputs VSEL (voltage U), CSEL (current I) and PSEL (power P, where adjustable) have to be given with external, analog voltages. For 0...100% value on the DC output it requires either 0...5V or 0...10V input voltage on these inputs.

Note

*Remote control via analog interface always requires to put in all **three** set values.*

Wiring example:

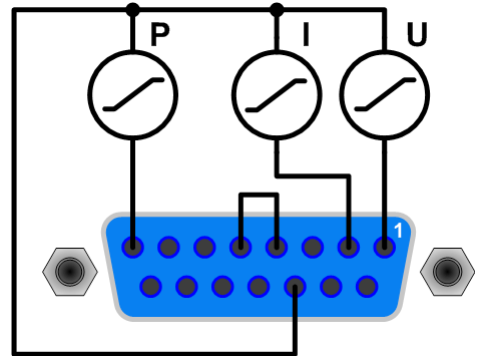

Measuring actual values

Measuring the monitor outputs of the actual values is independent from remote control. Since there is no power monitor output, only voltage and current monitor can be measured. The pins VMON and CMON represent the actual DC output values with either 0...10V or 0...5V for 0...100%.

By using an external analog multiplier, the power monitor could be calculated.

Wiring example:

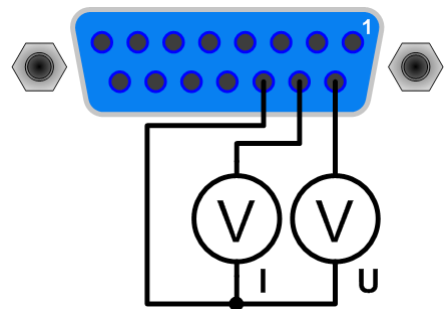

Notifications

The analog interface features further outputs like OVP or CV to notify the user of alarms or conditions (see table in „10.5. Pin specifications“).

These outputs are internally pulled to a voltage source via a high resistor and can not drive a LED or lamp. They're intended for current intake by switching an external relay or similar, which can drive LED, lamps or other indicators.

Alternatively, these outputs can be connected to inputs of logic ICs.

Example:

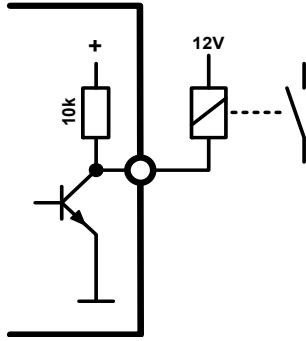

10.5 Pin specifications

Pin	Name	Type*	Description	Level	Electrical specification
1	VSEL	AI	Set value: voltage	0...10V or 0...5V correspond to 0..100% of U_{Nom}	Accuracy: < 0.2% @ 0...10V range Accuracy: < 0.4% @ 0...5V range
2	CSEL	AI	Set value: current	0...10V or 0...5V correspond to 0..100% of I_{Nom}	
3	N.C.				Not connected
4	DGND	POT	Reference potential		For +Vcc and digital control and status signals
5	REMOTE	DI	Toggle between internal or external control	External = LOW***, $U_{Low} < 1V$ Internal = HIGH, $U_{High} > 4V$ Internal = open	U range = 0 ...30V $I_{Max} = +1mA$ at 5V Sender: Open collector against DGND
6	OT	DO	Overtemperature error	OT/PF = HIGH, $U_{High} > 4V$ no error = LOW***, $U_{Low} < 1V$	Quasi open collector with pull-up to Vcc ** At 5V at the output there will be max.+1mA $I_{Max} = -10mA$ at $U_{CE} = 0.3V$ $U_{Max} = 0...30V$ Short-circuit-proof against DGND
7	N.C.				Not connected
8	PSEL	AI	Set value: power	0...10V or 0...5V correspond to 0..100% of P_{Nom}	Accuracy < 0.5% @ 0...10V range Accuracy < 1% @ 0...5V range
9	VMON	AO	Actual value: voltage	0...10V or 0...5V correspond to 0..100% of U_{Nom}	Accuracy < 0.2% at $I_{Max} = +2mA$ Short-circuit-proof against AGND
10	CMON	AO	Actual voltage: current	0...10V or 0...5V correspond to 0..100% of I_{Nom}	
11	AGND	POT	Reference potential		For -SEL, -MON signals
12	N.C.				Not connected
13	REM-SB	DI	Output off	off = LOW***, $U_{Low} < 1V$ on = HIGH, $U_{High} > 4V$ on = OPEN	U range = 0...30V $I_{Max} = +1mA$ at 5V Sender: Open collector against DGND
14	OVP	DO	Overvoltage error	OVP = HIGH, $U_{High} > 4V$ no OVP = LOW***, $U_{Low} < 1V$	Quasi open collector with pull-up to Vcc ** At 5V at the output there will be max.+1mA $I_{Max} = -10mA$ at $U_{ce} = 0.3V$ $U_{Max} = 0...30V$ Short-circuit-proof against DGND
15	CV	DO	Indication of voltage regulation active	CV = LOW***, $U_{Low} < 1V$ CC = HIGH, $U_{High} > 4V$	$U_{Max} = 0...30V$ Short-circuit-proof against DGND

* AI = Analog input, AO = Analog output, DI = Digital input, DO = Digital output, POT = Potential

** Internal pull-up voltage approx. 13...14V *** Default setting, can be modified in the setup menu

11. PV - Solar panel simulation

The integrated photovoltaics feature enables the power supply to simulate the characteristics of a solar panel. It's a combination of hardware and software. The PV feature can be enabled and disabled in the device setup, as described in section „7.8. Activating the photovoltaics feature“. If disabled, the power supply acts like a standard power supply unit. If enabled, the power set value is directly effected by the current set value, resulting in a voltage-current-power behaviour that is related to a certain characteristics curve similar to solar panels.

11.1 Special conditions

Following applies for PV operation:

- If the output is switched off, the start values of power and current can be set
- The power set value can not be changed if the output is on and is calculated depending on the set value of current
- If the output is on, the power set value display changes according to the current set value adjustment
- Remote control of PV operation via digital or analog interface is possible the same way as with manual control on the front panel
- When switching the output off again the start values, which have been set before the output was switched on the last time, are restored
- The calculated power, which depends on the current set value, is clipped to the maximum power of the device

11.2 Setup and handling

With the DC-AC-inverter connected, the procedure to run a simulation of a solar panel is like this:

1. With the power supply DC output switched **off** and PV feature activated, you need to adjust initial power and initial current set values, which characterise the solar panel that is going to be simulated.

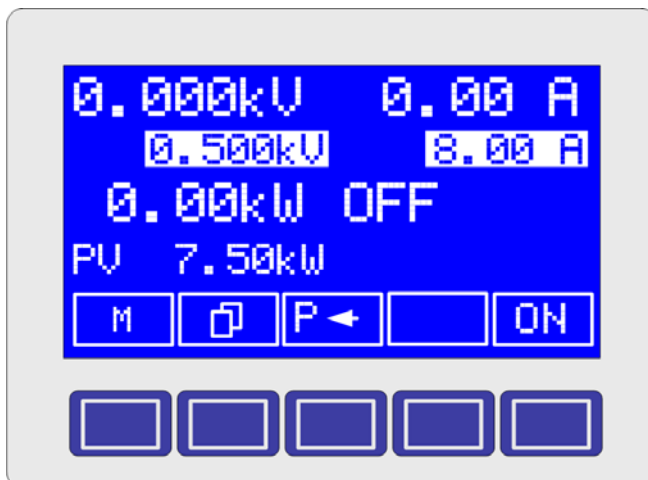

Figure 11. Adjusting the solar panel short-circuit current

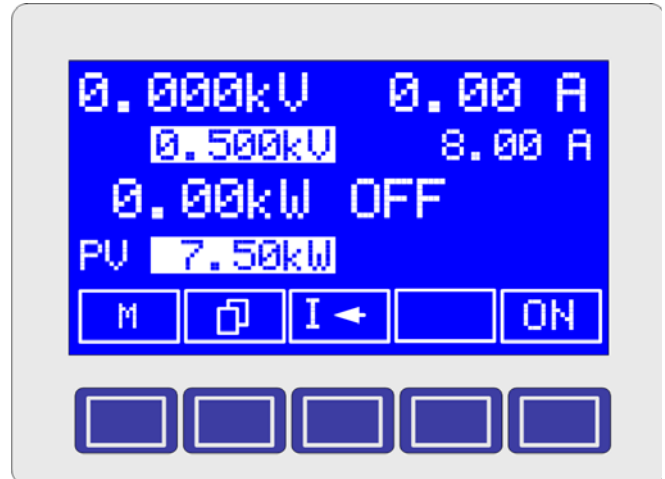

Figure 12. Adjustment of maximum power

2. Switch the output on. Power is not adjustable anymore then.
3. The DC output will be set to a calculated idle voltage (read below)
4. Switch the DC-AC inverter on.

The power supply will then turn the adjusted initial values into the power characteristics curve of the simulated solar panel. The curve in the figure below depicts an example with initial current = 8A und initial power (MPP) = 8kW. The U_{MPP} and U_{Idle} result automatically according to the U-I characteristics.

Note

Together with this operating guide you should have received a CD that contains calculation tools in form of Microsoft Excel sheets, one for each PV model. Those sheets are used to enter the same initial values for the simulated solar panel and to generate and display the resulting characteristics curve.

You can now run a test with the inverter. In order to simulate different illumination situations, you can

5. Adjust the current set value of the power supply.

When the output is switched off again, power and current are rest to the initial testing values.

Attention!

The DC output voltage (or simulated solar panel voltage) is depending on the settings of power and current. Wrong values may result in an output voltage higher than the DC-AC inverter can take. In order to protect the inverter, you are advised to always set the overvoltage protection threshold (OVP) to the maximum inverter input voltage. See section 7.6.1, item Uovp.

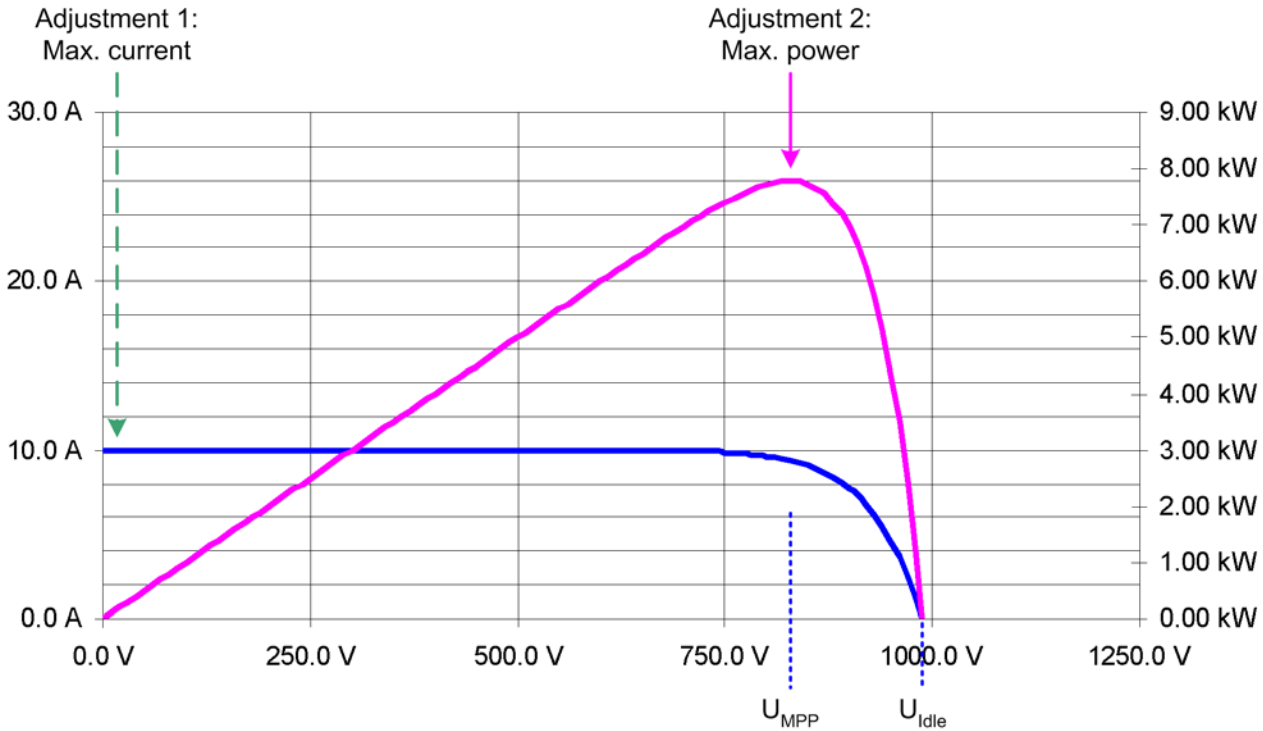

Figure 13. Expected PV curve of the simulation

11.3 Notes & limitations

- If the output condition shall not be restored to ON after the device is powered, disable this feature. See section „7.1. Defining operation parameters“, item „Output condition after ‚power on““.
- During remote control via an analog interface the preset values of current and power (see above) can not be restored after switching the output off, because the set value input PSEL and CSEL constantly set new values and thus the preset values in OFF mode will be the last one that were present on the inputs.
- If PV mode is activated in the setup (menu „Options“), the function manager (SEQ) is not accessible.

12. HS - High speed ramping

The power supply features an integrated HS feature which provides improved dynamics of the output voltage due to reduced output capacities.

This is a permanent modification which can not be deactivated and will effect some of the standard technical specifications. See table on the next page.

⚠ Voltage overshoot!

Power supplies with High Speed option can produce very high voltage overshoots on the output, if the load changes. The electric strength of connected loads must be observed!

12.1 Restrictions

- In combination with option “ZH”, the DIN curve of option ZH is only guaranteed up to 80V output voltage
- Remote sense operation and series connection are not available and not allowed!
- The fall time t_{Fall} is load depending and can be calculated by the user from the given output capacity
- In case the given time and power dissipation for permanent pulsed operation are not adhered, the warranty claim expires

12.2 Terms explained

C_{OUT}

Remaining output capacity of the modified unit, is used to calculate time values regarding the dynamics of the output voltage.

$U_{MIN}> / P_{MIN}>$

Recommended minimum output voltage resp. minimum actual power the device should be operated with. Below these values the output ripple is expected to be even higher than stated in the tables above.

Fall time

Together with the rise time, this is an important value regarding the output voltage dynamics. This value is primarily depending on the load's resistance. Models with additional ZH option achieve even shorter fall times.

Rise time

Together with the fall time, this is an important value regarding the output voltage dynamics. This values is depending on the output capacity, the load's resistance and the adjusted current limit.

12.3 General operation instructions

Permanent remote control which results in a big $\Delta U/\Delta t$ is allowed, as long as a certain total internal power dissipation loss is not exceeded. It is calculated with the formula $dU_{max} = \sqrt{(F / f)}$ (if frequency is given) or $f_{max} = F / dU^2$ (if voltage difference is given) and with $F = 192000$ for permanent pulsed operation, whereas f is the frequency of the pulsed operation, dU the voltage difference of the rising or falling edge and F a factor. Permanent pulsed operation here means for hours or days. Short-time operation, e.g. some minutes followed by a break of the same period, allows higher load dynamics with $F = 256000$.

Recommended minimum output voltage resp. minimum actual power the device should be operated with. Below these values the output ripple is expected to be even higher than stated in the tables above.

12.4 Specific instructions for the 1500V model

Extreme pulse-shaped unload, for example 90% I_{nom} -> 5% I_{nom} , can produce a voltage rise of up to +100V. Otherwise, a voltage rise of 40V...60V is typical.

The time of the falling edge is load-dependent. With, for example, 1A constant load t_{fall} will be ~67V/ms, at no-load condition it is always 1.7s down to 0V.

12.5 Altered technical specifications

Model	600V / 70A	1000V / 30A	1500V / 30A
Output capacity C_{out}	34 μ F	22.5 μ F	15 μ F
HF ripple constant voltage operation (BW=20MHz)*	<3V _{pp}	<600mV _{pp}	<1.5V _{pp}
LF ripple constant voltage operation (BW=20MHz)*	<2.2mV _{pp}	<60mV _{pp}	<1V _{pp}
Ripple constant voltage operation (BW=300kHz)*	<700mV _{eff}	<160mV _{eff}	<270mV _{eff}
HF ripple constant voltage operation (BW=20MHz)*	<300mA _{pp}	<30mA _{pp}	<40mA _{pp}
NF ripple constant voltage operation (BW=20MHz)*	<4000mA _{pp}	<8mA _{pp}	<40mA _{pp}
Ripple constant voltage operation (BW=300kHz)*	<180mA _{eff}	<10mA _{eff}	<14mA _{eff}
Regulation 10%...90% I_{Max} ** (in CV)	<4ms	<2ms	<2ms
Regulation 90%...10% I_{Max} ** (in CV)	<4ms	<3ms	<2ms
Rise time t_{Rise} for 10%...90% U_{Nom} (no load)	<1,2ms	<3,2ms	<1ms
Rise time t_{Rise} for 10%...90% U_{Nom} (70% load)	<1,6ms	<4ms	<1.2ms
Recommended f_{Max} for ΔU pulsed operation	250Hz	150Hz	500Hz
Fall time t_{Fall} for 100%...10% (1% ohmic load)	<190ms	<350ms	non-critical
Possible voltage overshoot (pulsed operation)	up to 150V	up to 150V	up to 100V
Recommended $U_{min}> / P_{min}>$	40V/100W	40V/160W	60V/240W

* Measured at $U_{out} \geq 10\%$ and $P_{out} \geq 5\%$

** I_{Max} is either equal to I_{Nom} (for devices without power limitation) or $I_{Max} = P_{Set}/U_{Set}$ (for devices with power limitation)

13. Other applications

13.1 Parallel connection in Share bus mode

Share bus operation is used to gain a symmetric load current distribution when running multiple units in parallel connection.

Important: in this operation mode, the unit with the highest output voltage controls and defines the output voltage of the whole parallel connection. It means, any unit of the system could be in charge. Thus it recommended to pick a unit that is used to control the whole system, while the set value of voltage for the remaining units is set to the required minimum. Voltage and power set value could be set to 100% or, if not desired, set to equal values on every unit so that the total results in what's required.

In case a unit is broken and will completely shut off, the parallel connection will continue to work without interruption. This is called redundancy.

The wiring of terminal „Share“, which is required for Share bus operation, is explained in section „5.8. Terminal „Share““. Also see figure 14.



Note

If remote sense is going to be used, it is recommended only to connect the „Sense“ input of the main unit that determines the system voltage.



Attention!

This is a purely analog connection. No totals formation of actual values on any of the units.



Attention!

Parallel connection with units different to 3U series, which also feature a Share bus, is not allowed!

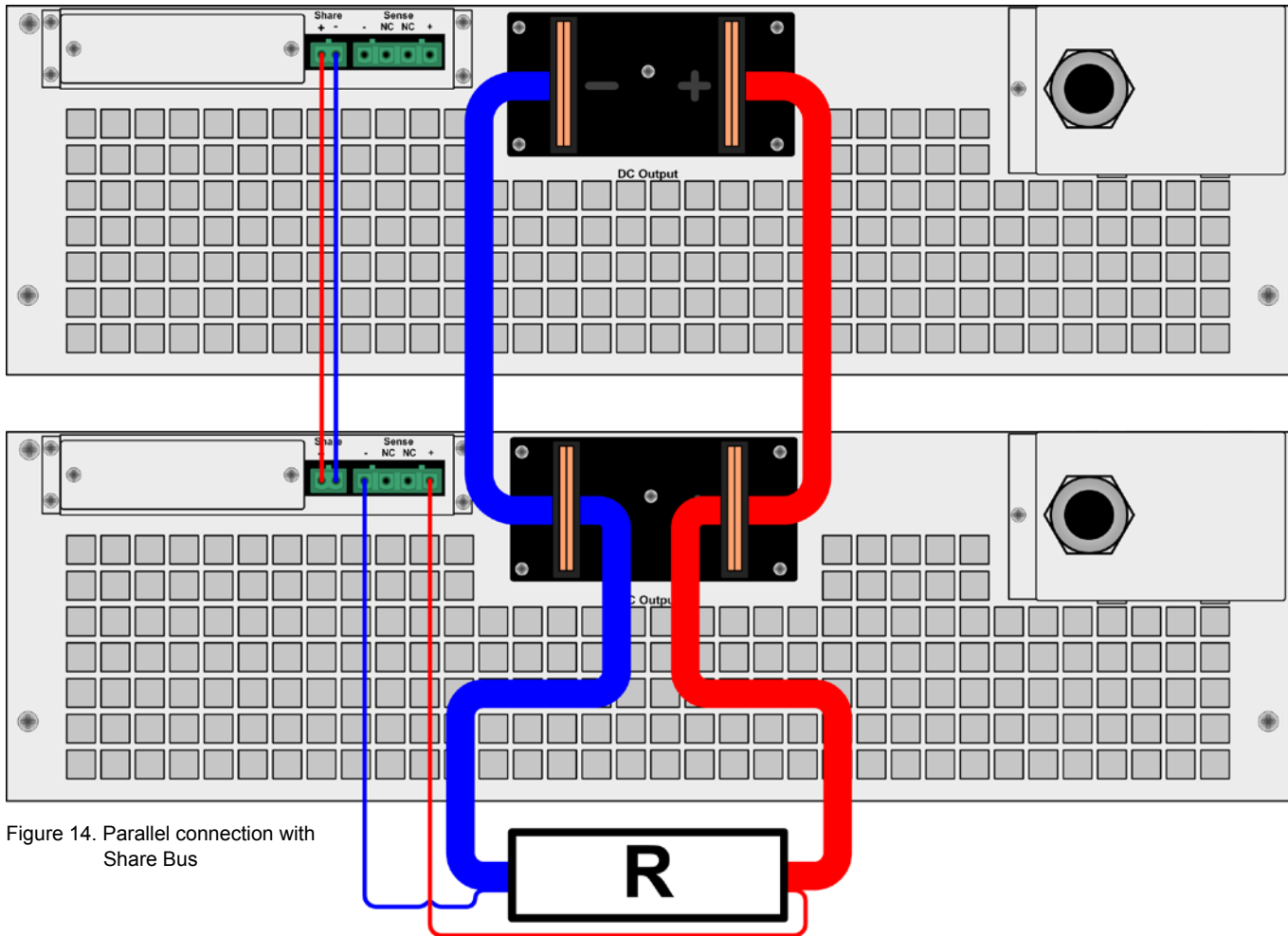

Figure 14. Parallel connection with Share Bus

13.2 Series connection

Series connection of two or more units is not allowed.

14. Miscellaneous

14.1 Accessories and options

Following accessories are optionally available:

a) Digital interface cards

Pluggable and retrofitable, digital interface cards for USB, RS232, CAN, GPIB/IEEE (SCPI only), Ethernet/LAN (SCPI only) are available. There is one interface card slot available with every device model.

b) Extended, analog interface card

Pluggable and retrofitable, galvanically isolated, 25 pole analog card. For details refer to the separate interface cards operating guide.

Following options are available:

a) Watercooling

Internally integrated water cooling block. The watercooling is used prevent premature shutdown of the power output because of overheating.

b) Internal resistance regulation

This option can be purchased subsequently and is unlocked with a code number in the device's setup menu.

After it is unlocked, the user can choose between U/I/P or U/I/R operation. The power set value will not be adjustable in U/I/R mode, it is then only defined as a limit in the device settings.

Note

It will eventually be required to update the device firmware before the option can be unlocked. Ask your supplier.

14.2 Firmware update

A firmware update of the device should only be done if the device shows erroneous behaviour or if new features have been implemented.

In order to update a device, it requires a certain digital interface card, a new firmware file and a Windows software called „Update tool“.

These interfaces are qualified to be used for a firmware update:

- IF-U1 (USB)
- IF-R1 (RS232)
- IF-E1 (Ethernet/USB)

In case none of the above interface types is at hand, the device can not be updated. Please contact your dealer for a solution.

The update tool and the particular firmware file for your device are obtainable from the website of the device manufacturer, or are mailed upod request. The update too will guide the user through the semi-automatic update process.

14.3 Option: Internal resistance

The unlockable option „internal resistance“ adds an imaginary, variable resistor to the internal voltage source of the power supply. After this option has been unlocked, the „R mode“ or

U//R mode can be activated in the menu  **Setup operation mode** (see section „7.1. Defining operation parameters“) by switching from U//P resp. U//I to U//R. The voltage set value is related to the off-load voltage U_0 of the power supply. The off-load voltage is reduced by the product of $I_{act} \cdot R_{i, set}$. The resulting voltage is calculated as follows:

$$U_{Set} = (U_0 - I_{Act} \cdot R_i) \Big|_{I_{set}, P_{set}}$$

Clarification:

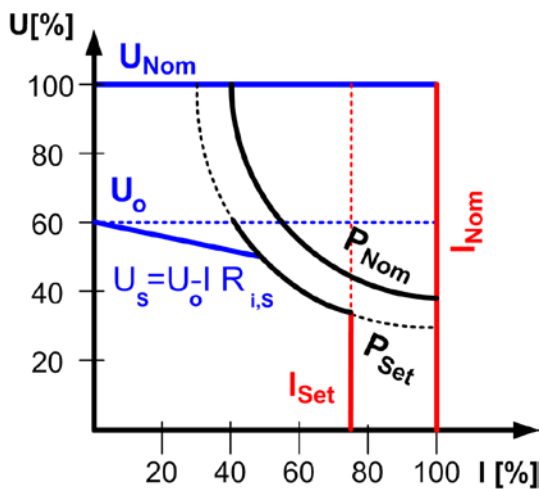
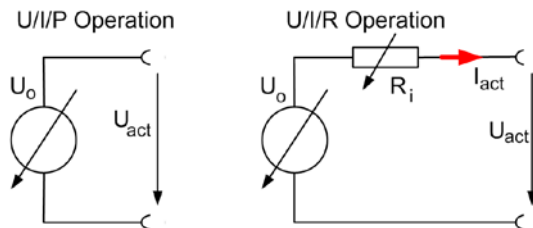

 **CR** is shown in the display while the internal resistance control is in control.

The internal resistance $R_{i, set}$ is displayed instead of the power P_{set} while U//R mode is active. However, the actual value of the power is still displayed.

Following restrictions apply for U//R mode:

- For models with adjustable power: activating U//R mode disables direct power value adjustment. The global output power can then only be set in the menu with the parameter „**Padj max.**“. When activating U//R mode, that value is instantly set as power set value for the output. It can be subsequently adjusted, too.
- The resistance set value can not be controlled via the internal or the optional analog interface. Therefore, remote control by analog interface is not possible as long as U//R mode is active
- Parallel or series connection of multiple units running in U//R mode is not possible and thus not allowed!
- It is not recommended to use the function manager while U//R mode is active, though it is possible. The resistance regulation will significantly slow down the function manager operation.

The unlock code can be purchased at the sales company who sold the power supply. The serial number of the unit is required to be told when purchasing the option, because the unlock code is related to it.

14.4 Networking

The figures below depict networking examples for the digital control of multiple devices in star-shaped (USB, RS232, Ethernet) or bus-like (CAN, GPIB, Profibus) configuration.

Limitations and technical specifications of the bus systems and the interfaces apply.

With **USB** up to 30 units can be controlled with one PC, appropriate USB hubs with custom power supply assumed. This basically applies to RS232, too. Differences lie in the handling and the cable lengths.

With **CAN** up to 30 power supplies per address segment can be integrated into a new or existing CAN bus system. They are addressed by the device node and the RID (see „7. Device configuration“).

With **GPIB** there is a limitation of max. 15 units on one bus, controlled by a GPIB master. Multiple GPIB masters can be installed in a PC in order to increase the number of addressable units.

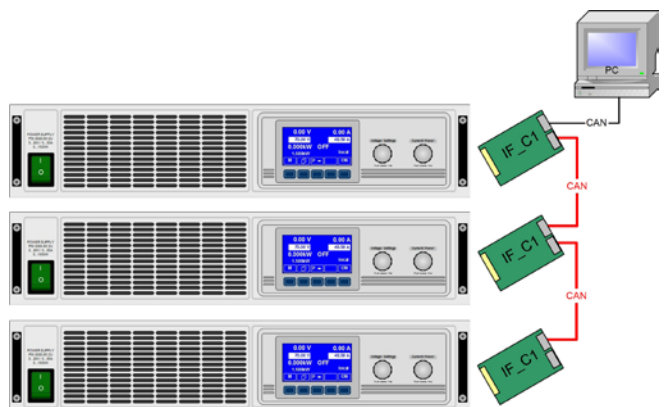

Figure 15. USB or RS232 networking

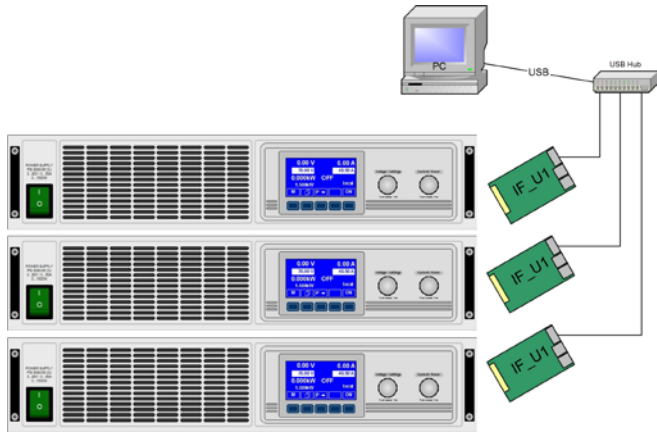

Figure 16. CAN networking example, also applies to GPIB



Elektro-Automatik

EA-Elektro-Automatik GmbH & Co. KG

研发 - 生产 - 销售一体化
Development - Production - Sales

Helmholtzstraße 31-33
41747 Viersen

Tel: +49 2162 / 37 85-0
Fax: +49 2162 / 16 230
ea1974@elektroautomatik.cn
www.elektroautomatik.cn