



## Operating Guide

# PSB 9000 2.5 kW

## Bidirectional DC Power Supply



Elektro-Automatik



Doc ID: PSB92EN

Revision: 01

Date: 03/2020





# TABLE OF CONTENTS

## 1 GENERAL

1.1	About this document	5
1.1.1	Retention and use	5
1.1.2	Copyright	5
1.1.3	Validity	5
1.1.4	Symbols and warnings	5
1.2	Warranty	5
1.3	Limitation of liability	5
1.4	Disposal of equipment	6
1.5	Product key	6
1.6	Intended usage	6
1.7	Safety	7
1.7.1	Safety notices	7
1.7.2	Responsibility of the user	8
1.7.3	Responsibility of the operator	8
1.7.4	User requirements	8
1.7.5	Alarm signals	9
1.8	Technical Data	9
1.8.1	Approved operating conditions	9
1.8.2	General technical data	9
1.8.3	Specific technical data	10
1.8.4	Views	14
1.8.5	Control elements	17
1.9	Construction and function	18
1.9.1	General description	18
1.9.2	Block diagram	18
1.9.3	Scope of delivery	19
1.9.4	Accessories	19
1.9.5	Options	19
1.9.6	The control panel (HMI)	20
1.9.7	USB port (rear side)	23
1.9.8	Interface module slot	23
1.9.9	Analog interface	24
1.9.10	“Share” connector	24
1.9.11	“Sense” connector (remote sensing)	24
1.9.12	Master-Slave bus	24
1.9.13	GPIB port (optional)	25

## 2 INSTALLATION & COMMISSIONING

2.1	Transport and storage	26
2.1.1	Transport	26
2.1.2	Packaging	26
2.1.3	Storage	26
2.2	Unpacking and visual check	26
2.3	Installation	26
2.3.1	Safety procedures before installation and use	26
2.3.2	Preparation	27
2.3.3	Installing the device	27
2.3.4	Connection to AC supply	28
2.3.5	Connection to DC loads or DC sources	31

2.3.6	Grounding of the DC terminal	32
2.3.7	Connecting the analog interface	32
2.3.8	Connection of remote sense	32
2.3.9	Installation of an interface module	33
2.3.10	Connecting the “Share” bus	34
2.3.11	Connecting the USB port (rear side)	34
2.3.12	Initial commission	34
2.3.13	Commission after a firmware update or a long period of non-use	34

## 3 OPERATION AND APPLICATION

3.1	Terms	35
3.2	Important notes	35
3.2.1	Personal safety	35
3.2.2	General	35
3.3	Operating modes	35
3.3.1	Voltage regulation / Constant voltage	35
3.3.2	Current regulation / constant current / current limiting	36
3.3.3	Power regulation / constant power / power limiting	36
3.3.4	Internal resistance regulation (source mode)	37
3.3.5	Resistance regulation / constant resistance (sink mode)	37
3.3.6	Sink-source mode switching	38
3.3.7	Dynamic characteristics and stability criteria	38
3.4	Alarm conditions	39
3.4.1	Power Fail	39
3.4.2	Overtemperature	39
3.4.3	Overvoltage protection	39
3.4.4	Overcurrent protection	39
3.4.5	Overpower protection	39
3.4.6	Safety OVP	40
3.5	Manual operation	41
3.5.1	Switching on the device	41
3.5.2	Switching off the device	41
3.5.3	Configuration via MENU	41
3.5.4	Adjustment limits	47
3.5.5	Changing the operating mode	47
3.5.6	Manual adjustment of set values	48
3.5.7	Switching the DC terminal on or off	49
3.5.8	Recording to USB stick (logging)	49
3.6	Remote control	51
3.6.1	General	51
3.6.2	Control locations	51
3.6.3	Remote control via a digital interface	51
3.6.4	Remote control via the analog interface (AI)	52
3.7	Alarms and monitoring	57
3.7.1	Definition of terms	57

3.7.2	Device alarm and event handling.....	57
3.8	Control panel (HMI) lock.....	59
3.9	Limits lock.....	60
3.10	Loading and saving a user profile .....	60
3.11	The function generator.....	61
3.11.1	Introduction.....	61
3.11.2	General.....	61
3.11.3	Method of operation.....	62
3.11.4	Manual operation .....	63
3.11.5	Sine wave function.....	64
3.11.6	Triangular function .....	64
3.11.7	Rectangular function.....	65
3.11.8	Trapezoidal function.....	66
3.11.9	DIN 40839 function .....	66
3.11.10	Arbitrary function.....	67
3.11.11	Ramp function.....	71
3.11.12	IU table function (XY table).....	72
3.11.13	Simple PV (photovoltaics) function .....	73
3.11.14	FC table function (fuel cell).....	75
3.11.15	Extended PV function according to EN 50530 .....	76
3.11.16	Battery test function .....	81
3.11.17	MPP tracking function.....	85
3.11.18	Remote control of the function generator....	87
3.12	Other applications.....	88
3.12.1	Parallel operation in master-slave (MS).....	88
3.12.2	Series connection .....	91
3.12.3	Operation as battery charger (source mode) .....	92

## 4 SERVICE AND MAINTENANCE

4.1	Maintenance / cleaning.....	92
4.2	Fault finding / diagnosis / repair.....	92
4.2.1	Firmware updates .....	92
4.3	Calibration .....	93
4.3.1	Preface .....	93
4.3.2	Preparation.....	93
4.3.3	Calibration procedure .....	93

## 5 CONTACT AND SUPPORT

5.1	Repairs .....	94
5.2	Contact options .....	94

## 1. General

### 1.1 About this document

#### 1.1.1 Retention and use

This document is to be kept in the vicinity of the equipment for future reference and explanation of the operation of the device. This document is to be delivered and kept with the equipment in case of change of location and/or user.

#### 1.1.2 Copyright

Reprinting, copying, also partially, usage for other purposes as foreseen of this manual are forbidden and breach may lead to legal process.



#### 1.1.3 Validity

This manual is valid for the following equipment:

Model	Article nr.	Model	Article nr.	Model	Article nr.
PSB 9060-120 3U	30008319	PSB 9200-70 3U	30008302	PSB 9500-30 3U	30008304
PSB 9080-120 3U	30008301	PSB 9360-40 3U	30008303	PSB 9750-20 3U	30008305

#### 1.1.4 Symbols and warnings

Warning and safety notices as well as general notices in this document are shown in a box with a symbol as follows:

	<b>Symbol for a life threatening danger</b>
	Symbol for general safety notices (instructions and damage protection bans) or important information for operation
	<i>Symbol for general notices</i>

## 1.2 Warranty

EA Elektro-Automatik guarantees the functional competence of the applied technology and the stated performance parameters. The warranty period begins with the delivery of free from defects equipment.

Terms of guarantee are included in the general terms and conditions (TOS) of EA Elektro-Automatik.

## 1.3 Limitation of liability

All statements and instructions in this manual are based on current norms and regulations, up-to-date technology and our long term knowledge and experience. The manufacturer accepts no liability for losses due to:

- Usage for purposes other than designed
- Use by untrained personnel
- Rebuilding by the customer
- Technical changes
- Use of not authorized spare parts

The actual delivered device(s) may differ from the explanations and diagrams given here due to latest technical changes or due to customized models with the inclusion of additionally ordered options.

## 1.4 Disposal of equipment

A piece of equipment which is intended for disposal must, according to European laws and regulations (ElektroG, WEEE) be returned to the manufacturer for scrapping, unless the person operating the piece of equipment or another, delegated person is conducting the disposal. Our equipment falls under these regulations and is accordingly marked with the following symbol:



## 1.5 Product key

Decoding of the product description on the label, using an example:

**PSB 9080 - 120 3U xxx**

	<b>US208V</b> = AC supply type, either 208 V three-phase or 230 single phase
	Construction (not always given): <b>3U</b> = 19" frame with 3U
	Maximum current of the device in Ampere
	Maximum voltage of the device in Volt
	Series: <b>9</b> = Series 9000
	Type identification: <b>PSB</b> = Power Supply Bidirectional

## 1.6 Intended usage

The equipment is intended to be used only as a variable voltage and current source or only as a variable current sink.

Typical application for a voltage source is DC power supply to any relevant user, including when used as battery charger to test charge various battery types, and for current sinks the replacement of an ohmic resistor by an adjustable electronic DC load in order to load relevant voltage and current sources of any type.



- Claims of any sort due to damage caused by non-intended usage will not be accepted
- All damage caused by non-intended usage is solely the responsibility of the operator

## 1.7 Safety

### 1.7.1 Safety notices

#### Mortal danger - Hazardous voltage



- **Electrical equipment operation means that some parts can be under dangerous voltage. Therefore all parts under voltage must be covered! This basically applies to all models, though 60 V models according to SELV can't generate hazardous DC voltage.**
- **Never touch cables or connectors directly after unplugging from mains supply as the danger of electric shock remains!**
- **Never touch the contacts on DC terminal directly after switching the device off, because when running in source mode there still can be dangerous voltage present, sinking more or less slowly depending on the load!**
- **There can be dangerous potential between DC minus to PE or DC plus to PE due to charged X capacitors, even when the DC terminal isn't switched on and the device is still running. Never touch PE and any of the DC poles at the same time with bare hands!**
- **Always follow 5 safety rules when working with electric devices:**
  - **Disconnect completely**
  - **Secure against reconnection**
  - **Verify that the system is dead**
  - **Carry out earthing and short-circuiting**
  - **Provide protection from adjacent live parts**
- **In situations where the device works in source mode, with a voltage > 0 adjusted and the DC output being on, the output voltage can remain at the last setting after switching the DC output off again, in case the set value of current for the internal load (sink mode) is set to 0**
- **Even with the DC terminal being switched off, the device can generate a small, not loadable voltage (< 2 V) on the DC terminal!**



- The equipment must only be used as intended
- The equipment is only approved for use within the connection limits stated on the product label.
- Do not insert any object, particularly metallic, through the ventilator slots
- Avoid any use of liquids near the equipment. Protect the device from wet, damp and condensation.
- When operating the device as power supply: do not connect loads, particularly such with low resistance, to the device while the DC output is switched on; sparking may occur which can cause burns as well as damage to the equipment and to the loads.
- When operating the device as electronic load: do not connect power sources to the device while the DC input is switched on; sparking may occur which can cause burns as well as damage to the equipment and to the source.
- ESD regulations must be applied when plugging interface cards or modules into the relative slot
- Interface cards or modules may only be attached or removed after the device is switched off. It isn't necessary to open the device.
- Do not connect external power sources with reversed polarity to the DC terminal! The equipment will be damaged, even when completely powered off.
- Never connect external power sources to the DC terminal that can generate a higher voltage than the rated voltage of the device!
- Never insert a network cable which is connected to Ethernet or its components into the master-slave sockets on the back side of the device!
- Always configure the various protecting features against overcurrent, overpower etc. for sensitive loads to what the target application requires!
- When operating the device as electronic load: always make sure that the energy recovery can feed back the inverted energy and that it does not switch to isolated operation. For situations of isolated operation a supervision device (AIU, grid and plat protection) has to be installed
- It isn't allowed to run the device on AC sources such as generators or UPS equipment. It must only be connected to a power grid!

## 1.7.2 Responsibility of the user

The equipment is in industrial operation. Therefore the operators are governed by the legal safety regulations. Alongside the warning and safety notices in this manual the relevant safety, accident prevention and environmental regulations must also be applied. In particular the users of the equipment:

- must be informed of the relevant job safety requirements
- must work to the defined responsibilities for operation, maintenance and cleaning of the equipment
- before starting work must have read and understood the operating manual
- must use the designated and recommended safety equipment.

Furthermore, anyone working with the equipment is responsible for ensuring that the device is at all times technically fit for use.

## 1.7.3 Responsibility of the operator

Operator is any natural or legal person who uses the equipment or delegates the usage to a third party, and is responsible during its usage for the safety of the user, other personnel or third parties.

The equipment is in industrial operation. Therefore the operators are governed by the legal safety regulations. Alongside the warning and safety notices in this manual the relevant safety, accident prevention and environmental regulations must also be applied. In particular the operator has to

- be acquainted with the relevant job safety requirements
- identify other possible dangers arising from the specific usage conditions at the work station via a risk assessment
- introduce the necessary steps in the operating procedures for the local conditions
- regularly control that the operating procedures are current
- update the operating procedures where necessary to reflect changes in regulation, standards or operating conditions.
- define clearly and unambiguously the responsibilities for operation, maintenance and cleaning of the equipment.
- ensure that all employees who use the equipment have read and understood the manual. Furthermore the users are to be regularly schooled in working with the equipment and the possible dangers.
- provide all personnel who work with the equipment with the designated and recommended safety equipment

Furthermore, the operator is responsible for ensuring that the device is at all times technically fit for use.

## 1.7.4 User requirements

Any activity with equipment of this type may only be performed by persons who are able to work correctly and reliably and satisfy the requirements of the job.

- Persons whose reaction capability is negatively influenced by e. g. drugs, alcohol or medication may not operate the equipment.
- Age or job related regulations valid at the operating site must always be applied.



### **Danger for unqualified users**

**Improper operation can cause person or object damage. Only persons who have the necessary training, knowledge and experience may use the equipment.**

**Delegated persons** are those who have been properly and demonstrably instructed in their tasks and the attendant dangers.

**Qualified persons** are those who are able through training, knowledge and experience as well as knowledge of the specific details to carry out all the required tasks, identify dangers and avoid personal and other risks.

All work on electrical equipment may only be performed by qualified electricians.



## 1.7.5 Alarm signals

The equipment offers various possibilities for signalling alarm conditions, however, not for danger situations. The signals may be optical (on the display as text), acoustic (piezo buzzer) or electronic (pin/status output of an analog interface). All alarms will cause the device to switch off the DC terminal.

The meaning of the signals is as follows:

Signal <b>OT</b> (OverTemperature)	<ul style="list-style-type: none"> <li>• Overheating of the device</li> <li>• DC terminal will be switched off</li> <li>• Non-critical</li> </ul>
Signal <b>OVP</b> (OverVoltage)	<ul style="list-style-type: none"> <li>• Overvoltage shutdown of the DC terminal due to high voltage entering the device or generated by the device itself due to a defect</li> <li>• Critical! The device and/or the load could be damaged</li> </ul>
Signal <b>OCP</b> (OverCurrent)	<ul style="list-style-type: none"> <li>• Shutdown of the DC terminal due to excess of the preset limit</li> <li>• Non-critical, protects the load or source from excessive current consumption</li> </ul>
Signal <b>OPP</b> (OverPower)	<ul style="list-style-type: none"> <li>• Shutdown of the DC terminal due to excess of the preset limit</li> <li>• Non-critical, protects the load or source from excessive power consumption</li> </ul>
Signal <b>PF</b> (Power Fail)	<ul style="list-style-type: none"> <li>• DC terminal shutdown due to AC undervoltage or defect in the AC section</li> <li>• Critical on overvoltage! AC section could be damaged</li> </ul>

## 1.8 Technical Data

### 1.8.1 Approved operating conditions

- Use only inside dry buildings
- Ambient temperature 0-50°C (32-122 °F)
- Operational altitude: max. 2000 m (1.242 mi) above sea level
- Max 80% relative humidity, not condensing

### 1.8.2 General technical data

Display: Colour TFT touch screen with gorilla glass, 4.3", 480pt x 272pt, capacitive

Controls: 2 rotary knobs with pushbutton function, 1 pushbutton

The nominal values for the device determine the maximum adjustable ranges.

## 1.8.3 Specific technical data

2.5 kW	Model		
	PSB 9060-120	PSB 9080-120	PSB 9200-70
<b>AC supply</b>			
Voltage range, frequency	Two phase (L-L): 208 V, $\pm 10\%$ , 45...66 Hz Single phase (L-N): 220 / 230 / 240 V, $\pm 10\%$ , 45...66 Hz		
Leak current	< 3.5 mA		
Power factor	$\approx 0.99$		
Efficiency of energy recovery	$\leq 92.5\%$	$\leq 92.5\%$	$\leq 93.5\%$
<b>DC terminal</b>			
Max. voltage $U_{Max}$	60 V	80 V	200 V
Max. current $I_{Max}$	120 A	120 A	70 A
Max. power $P_{Max}$	2500 W	2500 W	2500 W
Overvoltage protection range	0...66 V	0...88 V	0...220 V
Overcurrent protection range	0...132 A	0...132 A	0...77 A
Overpower protection range	0...2750 W	0...2750 W	0...2750 W
Capacitance (approx.)	7990 $\mu\text{F}$	7990 $\mu\text{F}$	2520 $\mu\text{F}$
Temperature coefficient for set values $\Delta/K$	Voltage / current: 100 ppm		
<b>Voltage regulation (general)</b>			
Adjustment range	0...61.2 V	0...81.6 V	0...204 V
Accuracy <sup>(1)</sup> (at $23 \pm 5 \text{ }^\circ\text{C}$ / $73 \pm 9 \text{ }^\circ\text{F}$ )	< 0.1% $U_{Max}$	< 0.1% $U_{Max}$	< 0.1% $U_{Max}$
Line regulation at $\pm 10\% \Delta U_{AC}$	< 0.02% $U_{Max}$	< 0.02% $U_{Max}$	< 0.02% $U_{Max}$
Display: Resolution	See section „1.9.6.4. Resolution of the displayed values“		
Display: Accuracy <sup>(3)</sup>	$\leq 0.1\% U_{Max}$	$\leq 0.1\% U_{Max}$	$\leq 0.1\% U_{Max}$
Remote sensing compensation	Max. 5% $U_{Max}$	Max. 5% $U_{Max}$	Max. 5% $U_{Max}$
<b>Voltage regulation (power supply)</b>			
Load regulation at 0...100% $\Delta I_{OUT}$	< 0.05% $U_{Max}$	< 0.05% $U_{Max}$	< 0.05% $U_{Max}$
Rise time 10...90% $\Delta U_{OUT}$	Max. 30 ms	Max. 30 ms	Max. 30 ms
Transient time after load step	< 1.5 ms	< 1.5 ms	< 1.5 ms
Ripple <sup>(2)</sup>	< 200 mV <sub>PP</sub> < 16 mV <sub>RMS</sub>	< 200 mV <sub>PP</sub> < 16 mV <sub>RMS</sub>	< 300 mV <sub>PP</sub> < 40 mV <sub>RMS</sub>
Fall time at no load after switching DC output off	Down from 100% to <60 V: less than 10 s		
<b>Voltage regulation (el. load)</b>			
Load regulation at 0...100% $\Delta U$	< 0.05% $U_{Max}$	< 0.05% $U_{Max}$	< 0.05% $U_{Max}$
<b>Current regulation (general)</b>			
Adjustment range	0...122.4 A	0...122.4 A	0...71.4 A
Accuracy <sup>(1)</sup> (at $23 \pm 5 \text{ }^\circ\text{C}$ / $73 \pm 9 \text{ }^\circ\text{F}$ )	< 0.2% $I_{Max}$	< 0.2% $I_{Max}$	< 0.2% $I_{Max}$
Line regulation at $\pm 10\% \Delta U_{AC}$	< 0.05% $I_{Max}$	< 0.05% $I_{Max}$	< 0.05% $I_{Max}$
Display: Resolution	See section „1.9.6.4. Resolution of the displayed values“		
Display: Accuracy <sup>(3)</sup>	$\leq 0.1\% I_{Max}$	$\leq 0.1\% I_{Max}$	$\leq 0.1\% I_{Max}$
<b>Current regulation (power supply)</b>			
Load regulation at 0...100% $\Delta U_{OUT}$	< 0.15% $I_{Max}$	< 0.15% $I_{Max}$	< 0.15% $I_{Max}$
<b>Current regulation (el. load)</b>			
Load regulation at 0...100% $\Delta U_{IN}$	< 0.15% $I_{Max}$	< 0.15% $I_{Max}$	< 0.15% $I_{Max}$
Ripple <sup>(2)</sup>	< 80 mA <sub>RMS</sub>	< 80 mA <sub>RMS</sub>	< 22 mA <sub>RMS</sub>

(1 Related to the nominal values, the accuracy defines the maximum deviation between an adjusted values and the true (actual) value.

Example: an 80 V model has min. 0.1% voltage accuracy, that is 80 mV. When adjusting the voltage to 5 V, the actual value is allowed to differ max. 80 mV, which means it might be between 4.92 V and 5.08 V.

(2 RMS value: LF 0...300 kHz, PP value: HF 0...20MHz

(3 The display error adds to the error of the related actual value on the DC terminal

<b>2.5 kW</b>	<i>Model</i>		
	<i>PSB 9060-120</i>	<i>PSB 9080-120</i>	<i>PSB 9200-70</i>
<b>Power regulation</b>			
Adjustment range	0...2550 W	0...2550 W	0...2550 W
Accuracy <sup>(1)</sup> (at 23 ± 5 °C / 73±9 °F)	< 1% P <sub>Max</sub>	< 1% P <sub>Max</sub>	< 1% P <sub>Max</sub>
Line regulation at ±10% ΔU <sub>AC</sub>	< 0.05% P <sub>Max</sub>	< 0.05% P <sub>Max</sub>	< 0.05% P <sub>Max</sub>
Load reg. at 10-90% ΔU <sub>DC</sub> * ΔI <sub>DC</sub>	< 0.75% P <sub>Max</sub>	< 0.75% P <sub>Max</sub>	< 0.75% P <sub>Max</sub>
Display: Resolution	See section „1.9.6.4. Resolution of the displayed values“		
Display: Accuracy <sup>(2)</sup>	≤ 0.3% P <sub>Max</sub>	≤ 0.3% P <sub>Max</sub>	≤ 0.3% P <sub>Max</sub>
Efficiency <sup>(5)</sup>	≈ 93%	≈ 93%	≈ 95%
<b>Resistance regulation</b>			
Adjustment range	0.02...25 Ω	0.02...25 Ω	0.1...150 Ω
Accuracy <sup>(1)</sup> (at 23 ± 5 °C / 73±9 °F)	≤1% of max. resistance ± 0.3% of maximum current		
Display: Resolution	See section „1.9.6.4. Resolution of the displayed values“		
<b>Analog interface <sup>(3)</sup></b>			
Signals	See „3.6.4.4. Analog interface specification“		
Galvanic isolation to the device	Max. 725 V DC		
<b>Insulation</b>			
Allowed potential shift (floating voltage) on the DC terminal:			
Negative DC to PE	Max. ±400 V DC	±400 V DC	±725 V DC
Positive DC to PE	Max. ±400 V DC	±400 V DC	±1000 V DC
AC input <-> PE	2.5 kV DC		
AC input <-> DC terminal	2.5 kV DC		
<b>Miscellaneous</b>			
Cooling	Temperature controlled fans, front inlet, rear exhaust		
Ambient temperature	0...50 °C (32...133 °F)		
Storage temperature	-20...70 °C (-4...158 °F)		
Humidity	< 80%, not condensing		
Standards	EN 61010-1:2007-11, EN 50160:2011-02 EN 61000-6-2:2016-05, EN 61000-6-3:2011-09		
Overvoltage category	2		
Protection class	1		
Pollution degree	2		
Operational altitude	< 2000 m (1.242 mi)		
<b>Digital interfaces</b>			
Featured	1x USB-B for communication, 1x USB-A for functions, 1x GPIB (optional)		
Slot (standard version)	Optional: CANopen, Profibus, Profinet, RS232, CAN, Ethernet, ModBus TCP, Ether-CAT		
Galvanic isolation from device	Max. 725 V DC		
<b>Terminals</b>			
Rear side	Share Bus, DC terminal, AC supply, remote sensing, analog interface, USB, master-slave bus, interface module slot (standard version) or GPIB (optional)		
Front side	USB for sticks		
<b>Dimensions</b>			
Enclosure (W x H x D)	19" x 3U x 670 mm (26.4")		
Total (W x H x D)	483 x 133 x 775 mm (19" x 5.2" x 30.5")		
<b>Weight</b>	≈18 kg (39.7 lbs)	≈18 kg (39.7 lbs)	≈18 kg (39.7 lbs)
<b>Article number <sup>(4)</sup></b>	30008319	30008301	30008302

(1) Related to the nominal values, the accuracy defines the maximum deviation between an adjusted values and the true (actual) value. With the resistance, the accuracy rating already includes the error of the actual resistance display.

(2) The display error adds to the error of the related actual value on the DC terminal

(3) For technical specifications of the analog interface see „3.6.4.4 Analog interface specification“ on page 53

(4) Article number of the standard version, devices with options will have a different number

(5) Typical value at 100% voltage and 100% power

<b>2.5 kW</b>	<i>Model</i>		
	<i>PSB 9360-40</i>	<i>PSB 9500-30</i>	<i>PSB 9750-20</i>
<b>AC supply</b>			
Voltage range, frequency	Two phase (L-L): 208 V, ±10%, 45...66 Hz Single phase (L-N): 220 / 230 / 240 V, ±10%, 45...66 Hz		
Leak current	< 3.5 mA		
Power factor	≈ 0.99		
Efficiency of energy recovery	≤ 93.5%	≤ 94.5%	≤ 94.5%
<b>DC terminal</b>			
Max. voltage $U_{Max}$	360 V	500 V	750 V
Max. current $I_{Max}$	40 A	30 A	20 A
Max. power $P_{Max}$	2500 W	2500 W	2500 W
Overvoltage protection range	0...396 V	0...550 V	0...825 V
Overcurrent protection range	0...44 A	0...33 A	0...22 A
Overpower protection range	0...2750 W	0...2750 W	0...2750 W
Capacitance (approx.)	390 µF	180 µF	180 µF
Temperature coefficient for set values $\Delta/K$	Voltage / current: 100 ppm		
<b>Voltage regulation (general)</b>			
Adjustment range	0...367.2 V	0...510 V	0...765 V
Accuracy <sup>(1)</sup> (at 23 ± 5 °C / 73±9 °F)	< 0.1% $U_{Max}$	< 0.1% $U_{Max}$	< 0.1% $U_{Max}$
Line regulation at ±10% $\Delta U_{AC}$	< 0.02% $U_{Max}$	< 0.02% $U_{Max}$	< 0.02% $U_{Max}$
Display: Resolution	See section „1.9.6.4. Resolution of the displayed values“		
Display: Accuracy <sup>(3)</sup>	≤ 0.1% $U_{Max}$	≤ 0.1% $U_{Max}$	≤ 0.1% $U_{Max}$
Remote sensing compensation	Max. 5% $U_{Max}$	Max. 5% $U_{Max}$	Max. 5% $U_{Max}$
<b>Voltage regulation (power supply)</b>			
Load regulation at 0...100% $\Delta I_{OUT}$	< 0.05% $U_{Max}$	< 0.05% $U_{Max}$	< 0.05% $U_{Max}$
Rise time 10...90% $\Delta U_{OUT}$	Max. 30 ms	Max. 30 ms	Max. 30 ms
Transient time after $\Delta I_{OUT}$	< 1.5 ms	< 1.5 ms	< 1.5 ms
Ripple <sup>(2)</sup>	< 320 mV <sub>PP</sub> < 55 mV <sub>RMS</sub>	< 350 mV <sub>PP</sub> < 70 mV <sub>RMS</sub>	< 800 mV <sub>PP</sub> < 200 mV <sub>RMS</sub>
Fall time at no load after switching DC output off	Down from 100% to <60 V: less than 10 s		
<b>Voltage regulation (el. load)</b>			
Load regulation at 0...100% $\Delta U$	< 0.05% $U_{Max}$	< 0.05% $U_{Max}$	< 0.05% $U_{Max}$
<b>Current regulation (general)</b>			
Adjustment range	0...40.8 A	0...30.6 A	0...20.4 A
Accuracy <sup>(1)</sup> (at 23 ± 5 °C / 73±9 °F)	< 0.2% $I_{Max}$	< 0.2% $I_{Max}$	< 0.2% $I_{Max}$
Line regulation at ±10% $\Delta U_{AC}$	< 0.05% $I_{Max}$	< 0.05% $I_{Max}$	< 0.05% $I_{Max}$
Display: Resolution	See section „1.9.6.4. Resolution of the displayed values“		
Display: Accuracy <sup>(3)</sup>	≤ 0.1% $I_{Max}$	≤ 0.1% $I_{Max}$	≤ 0.1% $I_{Max}$
<b>Current regulation (power supply)</b>			
Load regulation at 0...100% $\Delta U_{OUT}$	< 0.15% $I_{Max}$	< 0.15% $I_{Max}$	< 0.15% $I_{Max}$
<b>Current regulation (el. load)</b>			
Load regulation at 0...100% $\Delta U_{IN}$	< 0.15% $I_{Max}$	< 0.15% $I_{Max}$	< 0.15% $I_{Max}$
Ripple <sup>(2)</sup>	< 18 mA <sub>RMS</sub>	< 16 mA <sub>RMS</sub>	< 16 mA <sub>RMS</sub>

(1 Related to the nominal values, the accuracy defines the maximum deviation between an adjusted values and the true (actual) value.  
Example: an 80 V model has min. 0.1% voltage accuracy, that is 80 mV. When adjusting the voltage to 5 V, the actual value is allowed to differ max. 80 mV, which means it might be between 4.92 V and 5.08 V.  
(2 RMS value: LF 0...300 kHz, PP value: HF 0...20MHz  
(3 The display error adds to the error of the related actual value on the DC terminal

<b>2.5 kW</b>	<i>Model</i>		
	<i>PSB 9360-40</i>	<i>PSB 9500-30</i>	<i>PSB 9750-20</i>
<b>Power regulation</b>			
Adjustment range	0...2550 W	0...2550 W	0...2550 W
Accuracy <sup>(1)</sup> (at 23 ± 5 °C / 73±9 °F)	< 1% P <sub>Max</sub>	< 1% P <sub>Max</sub>	< 1% P <sub>Max</sub>
Line regulation at ±10% ΔU <sub>AC</sub>	< 0.05% P <sub>Max</sub>	< 0.05% P <sub>Max</sub>	< 0.05% P <sub>Max</sub>
Load reg. at 10-90% ΔU <sub>DC</sub> * ΔI <sub>DC</sub>	< 0.75% P <sub>Max</sub>	< 0.75% P <sub>Max</sub>	< 0.75% P <sub>Max</sub>
Display: Resolution	See section „1.9.6.4. Resolution of the displayed values“		
Display: Accuracy <sup>(2)</sup>	≤ 0.3% P <sub>Max</sub>	≤ 0.3% P <sub>Max</sub>	≤ 0.3% P <sub>Max</sub>
Efficiency <sup>(5)</sup>	≈ 95%	≈ 95,5%	≈ 94%
<b>Resistance regulation</b>			
Adjustment range	0.3...520 Ω	0.5...1000 Ω	1.2...2200 Ω
Accuracy <sup>(1)</sup> (at 23 ± 5 °C / 73±9 °F)	≤1% of max. resistance ± 0.3% of maximum current		
Display: Resolution	See section „1.9.6.4. Resolution of the displayed values“		
<b>Analog interface <sup>(3)</sup></b>			
Signals	See „3.6.4.4. Analog interface specification“		
Galvanic isolation to the device	Max. 725 V DC	Max. 1500 V DC	Max. 1500 V DC
<b>Insulation</b>			
Allowed potential shift (floating voltage) on the DC terminal:			
Negative DC to PE	Max. ±725 V DC	±1500 V DC	±1500 V DC
Positive DC to PE	Max. ±1000 V DC	±1800 V DC	±1800 V DC
AC input <-> PE	2.5 kV DC		
AC input <-> DC terminal	2.5 kV DC		
<b>Miscellaneous</b>			
Cooling	Temperature controlled fans, front inlet, rear exhaust		
Ambient temperature	0...50 °C (32...133 °F)		
Storage temperature	-20...70 °C (-4...158 °F)		
Humidity	< 80%, not condensing		
Standards	EN 61010-1:2007-11, EN 50160:2011-02 EN 61000-6-2:2016-05, EN 61000-6-3:2011-09		
Overvoltage category	2		
Protection class	1		
Pollution degree	2		
Operational altitude	< 2000 m (1.242 mi)		
<b>Digital interfaces</b>			
Featured	1x USB-B for communication, 1x USB-A for functions, 1x GPIB (optional)		
Slot (standard version)	Optional: CANopen, Profibus, Profinet, RS232, CAN, Ethernet, ModBus TCP, Ether-CAT		
Galvanic isolation from device	Max. 725 V DC	Max. 1500 V DC	Max. 1500 V DC
<b>Terminals</b>			
Rear side	Share Bus, DC terminal, AC supply, remote sensing, analog interface, USB, master-slave bus, interface module slot (standard version) or GPIB (optional)		
Front side	USB for sticks		
<b>Dimensions</b>			
Enclosure (W x H x D)	19" x 3U x 670 mm (26.4")		
Total (W x H x D)	483 x 133 x 775 mm (19" x 5.2" x 30.5")		
<b>Weight</b>	≈18 kg (39.7 lbs)	≈18 kg (39.7 lbs)	≈18 kg (39.7 lbs)
<b>Article number <sup>(4)</sup></b>	30008303	30008304	30008305

(1) Related to the nominal values, the accuracy defines the maximum deviation between an adjusted values and the true (actual) value. With the resistance, the accuracy rating already includes the error of the actual resistance display.

(2) The display error adds to the error of the related actual value on the DC terminal

(3) For technical specifications of the analog interface see „3.6.4.4 Analog interface specification“ on page 53

(4) Article number of the standard version, devices with options will have a different number

(5) Typical value at 100% voltage and 100% power

1.8.4 Views

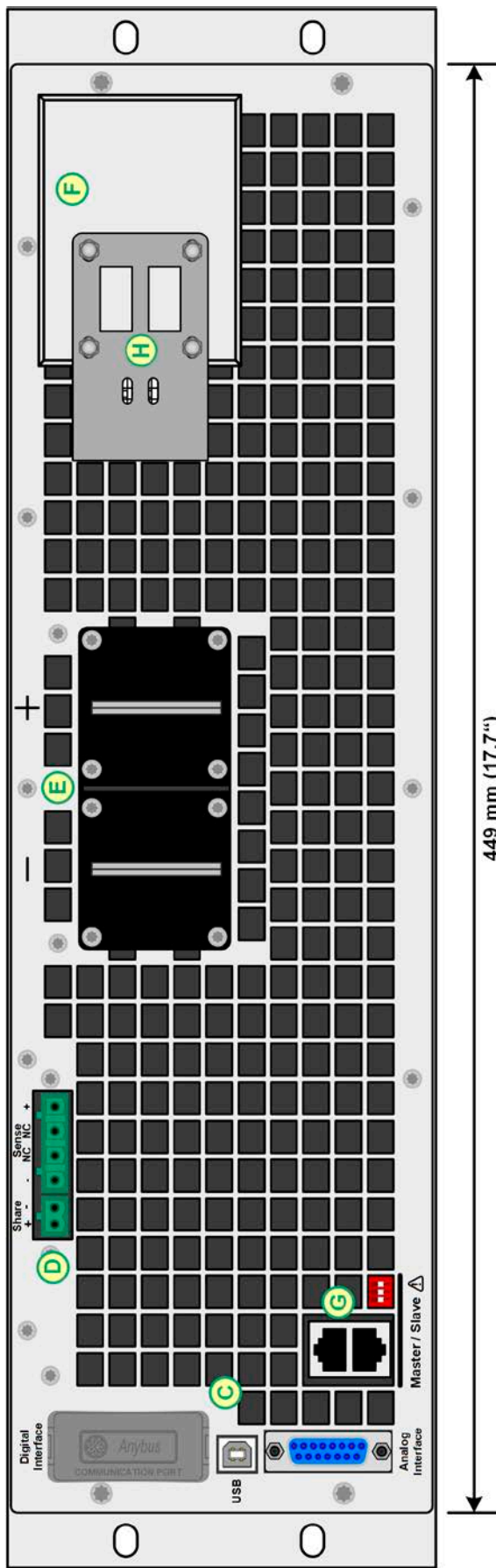
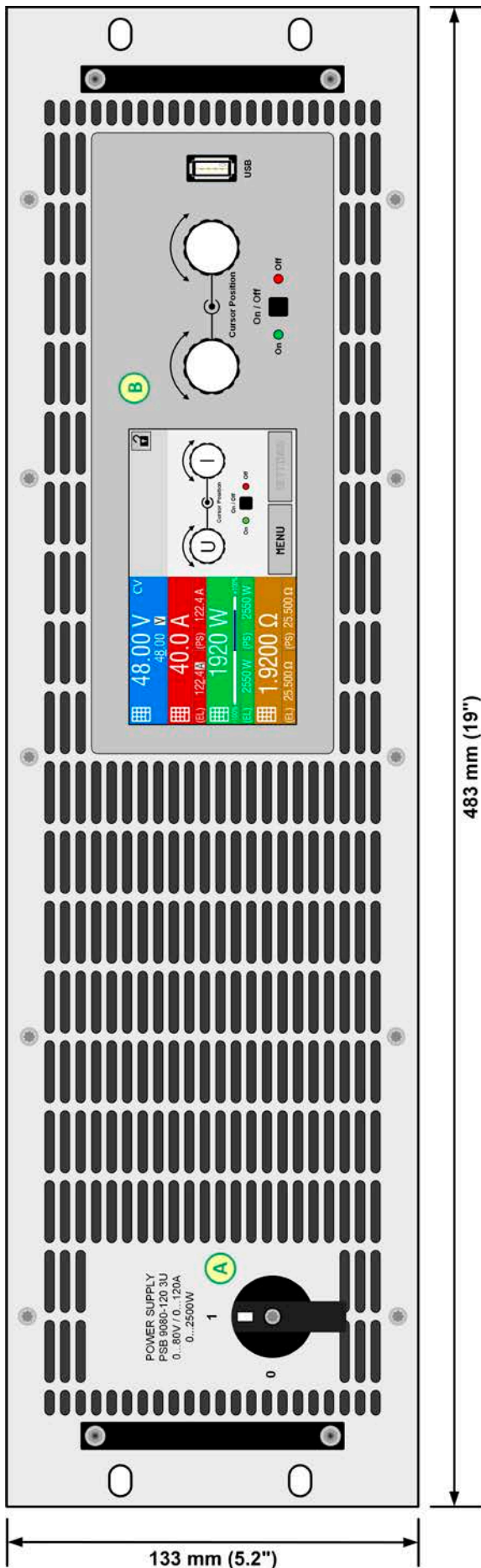

- A - Power switch
- B - Control panel
- C - Control interfaces (digital, analog)
- D - Share Bus and remote sensing connection
- E - DC terminal (view shows type 1)
- F - AC input connection (EU model shown)
- G - Master-Slave ports
- H - Plug fixture & strain relief

Figure 1 - Front view

Figure 2 - Rear view (standard version)

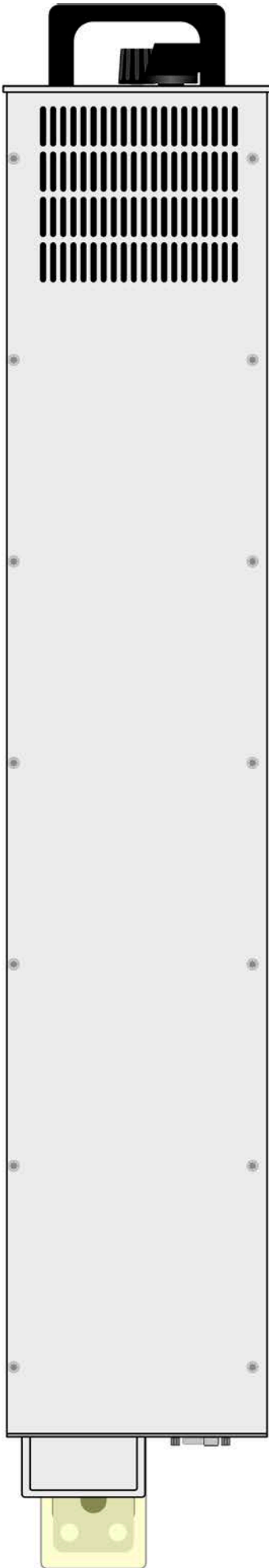

Figure 3 - Side view (left)

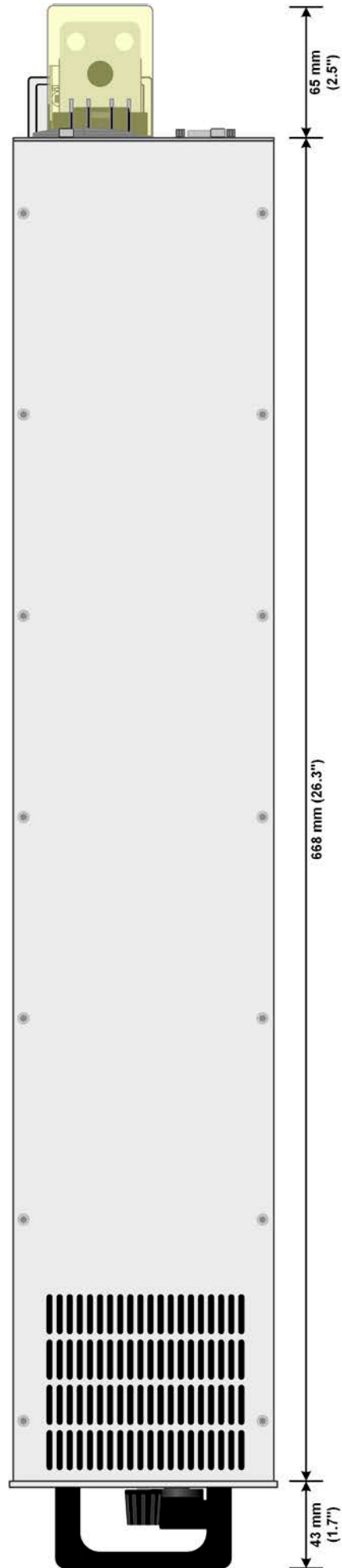

Figure 4 - Side view (right)

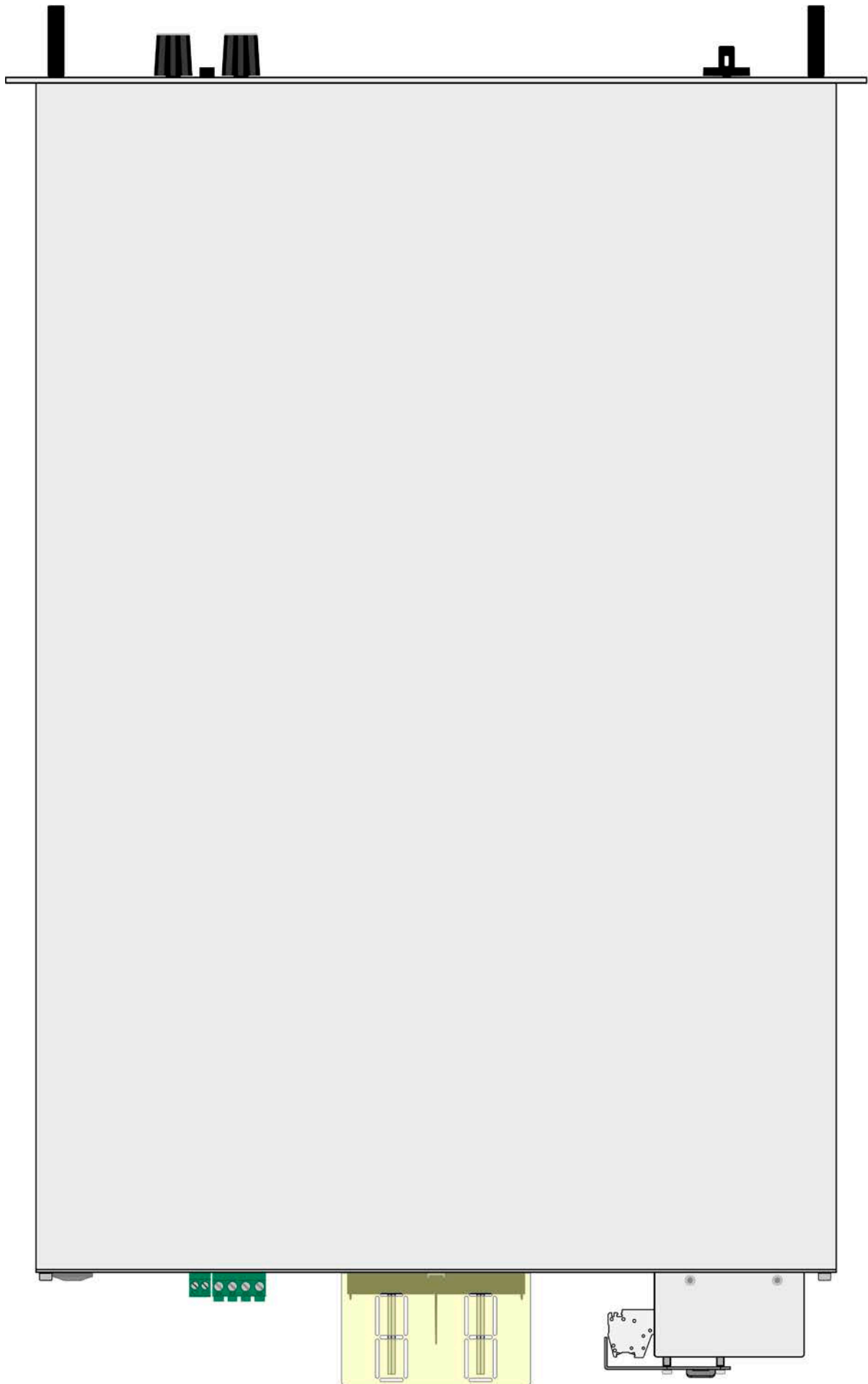

Figure 5 - Top view



1.8.5 Control elements

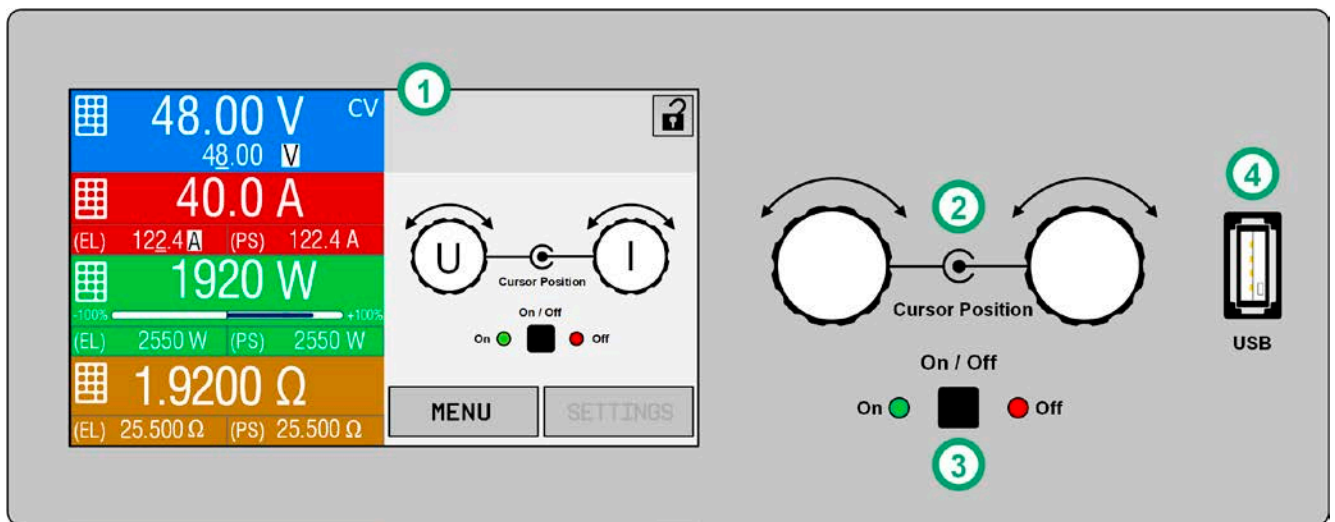

Figure 6- Control Panel

Overview of the elements on the control panel

For a detailed description see section „1.9.6. The control panel (HMI)“.

(1)	<p><b>Touchscreen display</b></p> <p>Used for selection of set values, menus and settings, as well as display of actual values and status. The touchscreen can be operated with the fingers or with a stylus.</p>
(2)	<p><b>Rotary knob with push button function</b></p> <p>Left knob (turn): adjusting the voltage set value, or setting the parameter values in the menu.</p> <p>Left knob (push): selection of the decimal position to be changed (cursor) in the current value selection.</p> <p>Right knob (turn): adjusting the current, power or resistance set value, or setting parameter values in the menu.</p> <p>Right knob (push): selection of the decimal position to be changed (cursor) in the current value selection.</p>
(3)	<p><b>On/Off Button for DC terminal</b></p> <p>Used to toggle the DC terminal between on and off, also used to start a function run. The LEDs “On” and “Off” indicate the state of the DC terminal, no matter if the device is manually controlled or remotely.</p>
(4)	<p><b>Port for USB sticks</b></p> <p>For the connection of standard USB sticks. See section „1.9.6.5. USB port (front side)“ for more details.</p>



## 1.9.3 Scope of delivery

- 1 x Bidirectional power supply device
- 1 x Share Bus plug
- 1 x Remote sensing plug
- 1 x 1.8 m (5.9 ft) USB cable
- 1 x Set of DC terminal covers
- 1 x Share/Sense terminal cover (only with models from 500 V)
- 1 x USB stick with documentation and software
- 1 x AC connector plug (clamp type)
- 1 x Set for strain relief & plug fixture (pre-mounted)

## 1.9.4 Accessories

For these devices the following accessories are available:

<b>Interface modules</b> <b>IF-AB</b>	Pluggable and retrofittable, digital interface modules for RS232, CANopen, Ethernet, Profibus, ProfiNet, ModBus TCP, EtherCAT or CAN are available. Details about the interface modules and the programming of the device using those interfaces can be found in separate documentation. It's usually available on the USB stick, which is included with the device, or as PDF download on the manufacturers website.
--	---

## 1.9.5 Options

These options are usually ordered along with the device, as they are permanently built in or preconfigured during the manufacturing process.

<b>POWER RACKS</b> 19"-rack	Racks in various configurations up to 42U as parallel systems are available, or mixed with electronic load devices to create test systems. Further information in our product catalogue, on our website or upon request
<b>3W</b> GPIB interface	Replaces the standard slot for pluggable interface modules by a rigidly installed GPIB port. Retrofitting only upon request. The device will keep the USB and analog interfaces. Via the GPIB port, it can only support SCPI commands.

## 1.9.6 The control panel (HMI)

The HMI (**H**uman **M**achine **I**nterface) consists of a display with touch screen, two rotary knobs, a pushbutton and an USB port.

### 1.9.6.1 Touchscreen display

The graphic touchscreen display is divided into a number of areas. The complete display is touch sensitive and can be operated by finger or stylus to control the equipment.

In normal operation the left hand side is used to show actual values and set values and the right hand side is used to display status information:

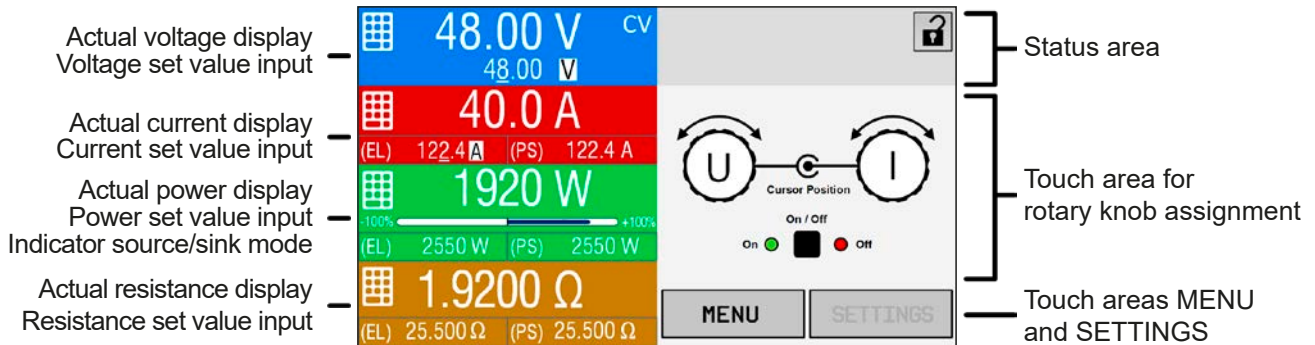

Touch areas may be enabled or disabled:



**MENU** Black text or symbol = Enabled      **SETTINGS** Grey text or symbol = Disabled

This applies to all touch areas on the main screen and all menu pages..

#### • Actual / set values area (left hand side)

In normal operation the actual values (large numbers) and set values (small numbers) for voltage, current and power on the DC terminal are displayed. For the two operation modes as sink (displayed as **EL**) and source (displayed as **PS**) there are two separate set values each for current, power and resistance. The two resistance set values are only displayed while resistance mode is active, while an actual resistance value is only available during sink mode operation.

The actual values of current and power can be negative (signed) or positive (unsigned). A negative value belongs to sink mode and indicates that the device is working as electronic load.

When the DC terminal is switched on, the actual regulation mode, **CV**, **CC**, **CP** or **CR** is displayed next to the corresponding actual value, as shown in the figure above with CV as example.

The set values can be adjusted with the rotary knobs next to the display screen or can be entered directly via the touchscreen. When adjusting with the knobs, pushing the knob will select the digit to be changed. Logically, the values are increased by clockwise turning and decreased by anti-clockwise turning.





General display and setting ranges:

Display	Unit	Range	Description
Actual voltage	V	0-125% $U_{Nom}$	Actual value of the voltage on the DC terminal
Set value of voltage	V	0-102% $U_{Nom}$	Set value for limiting the DC voltage
Actual current	A	0.2-125% $I_{Nom}$	Actual value of the current on the DC terminal
Set values of current	A	0-102% $I_{Nom}$	Set value for limiting the DC current
Actual power	W, kW	0-125% $P_{Nom}$	Actual value of power according to $P = U * I$
Set values of power	W, kW	0-102% $P_{Nom}$	Set value for limiting DC power
Set value of resistance	$\Omega$	$x^{(1)}$ -100% $R_{Max}$	Set value for the internal resistance
Adjustment limits	ditto	0-102% nom	U-max, I-min etc., related to the physical quantities
Protection settings	ditto	0-110% nom	OVP, OCP, OPP (related to U, I and P)

<sup>(1)</sup> Lower limit for resistance set value varies. See tables in section 1.8.3

## • Status display (upper right)

This area displays various status texts and symbols:

Display	Description
	The HMI is locked
	The HMI is unlocked
<b>Remote:</b>	The device is under remote control from....
<b>Analog</b>	....the built-in analog interface
<b>USB &amp; others</b>	....the built-in USB port or a plug in interface module
<b>Local</b>	The device has been locked by the user explicitly against remote control
<b>Alarm:</b>	Alarm condition which has not been acknowledged or still exists.
<b>Event:</b>	A user defined event has occurred which isn't yet acknowledged.
<b>Master</b>	Master-slave mode activated, device is master
<b>Slave</b>	Master-slave mode activated, device is slave
<b>Function:</b>	Function generator activated, function loaded
 / 	Data logging to USB stick active or failed

## • Area for assigning the rotary knobs

The two rotary knobs next to the display screen can be assigned to various functions. This area shows the actual assignments. These can be changed by tapping this area, as long as the panel isn't locked.

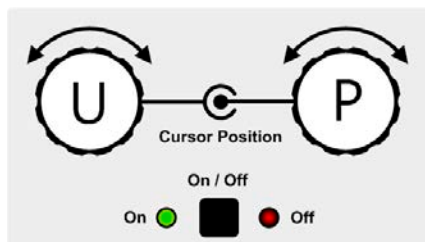

The physical quantities on the depiction of the knob show the current assignment. The left knob is always assigned to the voltage (U), while the right knob can be switched by tapping on the depiction.

The area will then show the assignment:

**U I**

Left rotary knob: voltage  
Right rotary knob: current

**U P**

Left rotary knob: voltage  
Right rotary knob: power

**U R**

Left rotary knob: voltage  
Right rotary knob: resistance  
(only with R mode active)

Due to the device having two set values each for current, power and resistance, tapping multiple times will cycle through the 4 or 6 assignable set values for this knob. The currently not selected set values can't be adjusted via the rotary knobs, unless the assignment is changed. Alternatively to tapping on the knob depiction, the assignment can also be changed by tapping the colored set value areas. However, values can be entered directly with a

ten-key pad by tapping on the small icon . **This method of entering values allows for big set value steps.**

### 1.9.6.2 Rotary knobs



As long as the device is in manual operation, the two rotary knobs are used to adjust set values, as well as setting the parameters in SETTINGS and MENU. For a detailed description of the individual functions see section „3.5. Manual operation“.

### 1.9.6.3 Pushbutton function of the knobs

The rotary knobs also have a pushbutton function which is used in all value adjustment to move the cursor by rotation like this:



## 1.9.6.4 Resolution of the displayed values

In the display, set values can be adjusted in fixed increments. The number of decimal places depends on the device model. The values have 4 or 5 digits. Actual and set values always have the same number of digits.

Adjustment resolution and number of digits of set values in the display:

Voltage, OVP, UVD, OVD, U-min, U-max			Current, OCP, UCD, OCD, I-min, I-max			Power, OPP, OPD, P-max			Resistance, R-max		
Nominal	Digits	Min. increment	Nominal*	Digits	Min. increment	Nominal*	Digits	Min. increment	Nominal	Digits	Min. increment
≤ 80 V	4	0.01 V	<100 A	4	0.01 A	2500 W	4	1 W	25 Ω	5	0.001 Ω
200 V	5	0.01 V	>100 A	4	0.1 A	MS	4	0.01 kW	150 Ω - 520 Ω	5	0.01 Ω
360 V	4	0.1 V	MS >1000 A	5	0.1 A				≥ 1000 Ω	5	0.1 Ω
500 V	4	0.1 V									
750 V	4	0.1 V									

\* MS = Master-slave

## 1.9.6.5 USB port (front side)

The frontal USB port, located to the right of the rotary knobs, is intended for the connection of standard USB sticks and can be used for loading or saving sequences for the arbitrary and the XY generator, as well as for recording measured data during running operation.

USB 2.0 sticks are widely accepted. USB 3.0 sticks work, but not from all manufacturers. The stick must be **FAT32** formatted and should have a **maximum capacity of 32 GB**. All supported files must be held in a designated folder in the root path of the USB drive in order to be found. This folder must be named **HMI\_FILES**, such that a PC would recognize the path G:\HMI\_FILES if the drive were to be assigned the letter G.

The control panel of the device can read the following file types and names from a stick:

File name	Description	Section
wave_u<arbitrary_text>.csv wave_i<arbitrary_text>.csv	Function generator for an arbitrary function on voltage (U) or current (I) The name must begin with <i>wave_u</i> / <i>wave_i</i> , the rest is user defined.	3.11.10.1
profile_<arbitrary_text>.csv	Previously saved user profile. A max. of 10 files to select from is shown when loading a user profile.	3.10
mpp_curve_<arbitrary_text>.csv	User-defined curve data (100 voltage values) for mode MPP4 of the MPPT function	3.11.17.5
psb_pv<arbitrary_text>.csv psb_fc<arbitrary_text>.csv	PV or FC table for the XY function generator. The name must begin with <i>psb_pv</i> or <i>psb_fc</i> , the rest can be user defined.	3.11.13 3.11.14
pv_day_et_<arbitrary_text>.csv pv_day_ui_<arbitrary_text>.csv	Day trend data file to load for the simulation modes DAY I/T and DAY U/I of the extended PV function.	3.11.15.5
iu<arbitrary_text>.csv	IU table for the XY function generator. The name must begin with <i>iu</i> , the rest can be user defined.	3.11.12

The control panel of the device can save the following file types and names to an USB stick:

File name	Description	Section
usb_log_<nr>.csv	File with log data recorded during normal operation in all modes. The file layout is identical to the those generated from the Logging feature in EA Power Control. The <nr> field in the file name is automatically counted up if equally named files already exist in the folder.	3.5.8
profile_<nr>.csv	Saved user profile. The number in the file name is a counter and not related to the actual user profile number in the HMI. A max. of 10 files to select from is shown when loading a user profile.	3.10
wave_u<nr>.csv wave_i<nr>.csv	Sequence point data (here: sequences) of either voltage U or current I from arbitrary function generator	3.11.10.1

File name	Description	Section
battery_test_log_<nr>.csv	File with log data recorded from the battery test function. For a battery test log, data different and/or additional to log data of normal USB logging is recorded.	3.11.16.7
mpp_result_<nr>.csv	Result data from MPP tracking mode 4 in form of a table with 100 data groups (Umpp, Impp, Pmpp)	3.11.17.6
psb_pv<nr>.csv	PF function table data, as calculated by the device. Can be loaded again.	3.11.13
psb_fc<nr>.csv	FC function table data, as calculated by the device. Can be loaded again.	3.11.14
pv_record_<nr>.csv	Data from the data recording option in the extended PV function according to EN 50530.	3.11.15.7

## 1.9.7 USB port (rear side)

The USB port on the back side of the device is provided for communication with the device and for firmware updates. The included USB cable can be used to connect the device to a PC (USB 2.0 or 3.0). The driver is delivered with the device and installs a virtual COM port. Details about remote control can be found in form of a programming guide on the included USB stick or on the web site of the manufacturer.

The device can be addressed via this port either using the international standard ModBus RTU protocol or by SCPI language. The device recognises the message protocol used automatically.

If remote control is in operation the USB port has no priority over either the interface module (see below) or the analog interface and can, therefore, only be used alternatively to these. However, monitoring is always available.

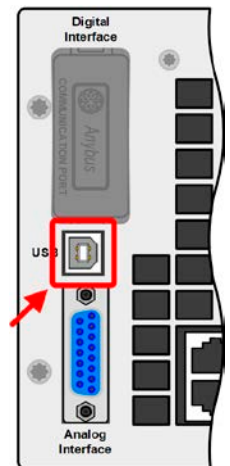

## 1.9.8 Interface module slot

This slot on the back side of the device (only with standard models, units with option 3W installed are different) is available for various modules of the IF-AB interface module series. The following options are available:

Article number	Name	Description
35400100	IF-AB-CANO	CANopen, 1x Sub-D 9pole male
35400101	IF-AB-RS232	RS 232, 1x Sub-D 9pole male (null modem)
35400103	IF-AB-PBUS	Profibus DP-V1 Slave, 1x Sub-D 9pole female
35400104	IF-AB-ETH1P	Ethernet, 1x RJ45
35400105	IF-AB-PNET1P	ProfiNET IO, 1x RJ45
35400107	IF-AB-MBUS1P	ModBus TCP, 1x RJ45
35400108	IF-AB-ETH2P	Ethernet, 2x RJ45
35400109	IF-AB-MBUS2P	ModBus TCP, 2x RJ45
35400110	IF-AB-PNET2P	ProfiNET IO, 2x RJ45
35400111	IF-AB-CAN	CAN 2.0 A / 2.0 B, 1x Sub-D 9-pole, male
35400112	IF-AB-ECT	EtherCAT, 1x RJ45

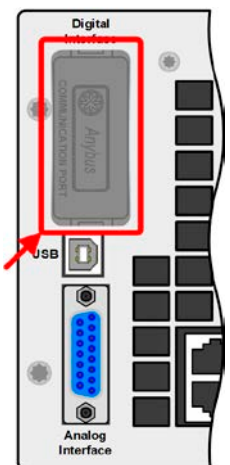

The modules can be installed by the user and hence retrofitted without problem. A firmware update of the device may be necessary in order to recognize and support certain modules.

If remote control is in operation the interface module has no priority over either any other interface and can, therefore, only be used alternately to these. However, monitoring is always available.



Switch your device off before adding or removing modules!

## 1.9.9 Analog interface

This 15 pole Sub-D socket on the back side of the device is provided for remote control of the device via analog or digital signals.

If remote control is in operation this analog interface can only be used alternately to the digital interface. However, monitoring is always available.

The input voltage range of the set values and the output voltage range of the monitor values, as well as reference voltage level can be switched in the settings menu of the device between 0-5 V and 0-10 V, in each case for 0-100%.

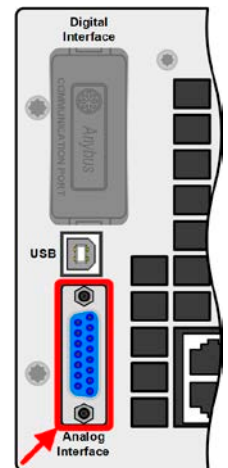

## 1.9.10 "Share" connector

The 2 pole socket named "Share" on the back side of the device is provided for connection to equally named sockets on compatible devices of different type and is used to achieve a balanced load current distribution while running the units in parallel connection. Following power supply and electronic load series are compatible:



- PSB 9000 3U / PSB 9000 Slave
- PSI 9000 2U - 24U / PSI 9000 3U Slave / PSI 9000 WR 3U / PSI 9000 WR 3U Slave
- ELR 9000
- EL 9000 B / EL 9000 B HP / EL 9000 B 2Q
- PSE 9000
- PS 9000 1U / 2U / 3U \*

\* Only from hardware revision 2, see type label (in case it does not show "Revision" on type label, it's revision 1)

## 1.9.11 "Sense" connector (remote sensing)

In order to compensate for voltage drops along the DC cables to the load or external source, the Sense input can be connected to the load or external source. The maximum possible compensation is given in the technical specifications.



- In order to ensure safety and to comply to international directives, insulation of high voltage models, i. e. such with a nominal voltage of 500 V or higher, is ensured by using only the two outer pins of the 4-pole terminal. The inner two pins, marked with NC, must remain unconnected.
- The two screws next to the Share bus and Sense connectors must remain firmly tightened all time, no matter if the safety cover (only with models from 500 V) is mounted or not!

## 1.9.12 Master-Slave bus

There is a further set of connectors on the rear side of the device, comprising two RJ45 sockets, which enables multiple identical devices to be connected via a digital bus (RS485) in order to create a master-slave system. Connection is made using standard CAT5 cables. These can theoretically have a length of up to 1200 m (3937 ft), but it's recommended to keep the connections as short as possible.

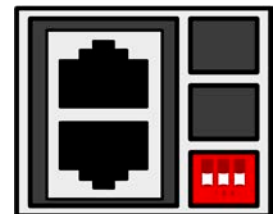



## 1.9.13 GPIB port (optional)

The optional GPIB connector, which is available with option 3W, will replace the module slot of standard version devices. The device then offers a three-way interface with GPIB, USB and analog.

The connection to a PC or other GPIB port is done with standard GPIB cables from stock, which can have straight or 90° connectors.

When using cable with 90° connectors, the USB port will be inaccessible.

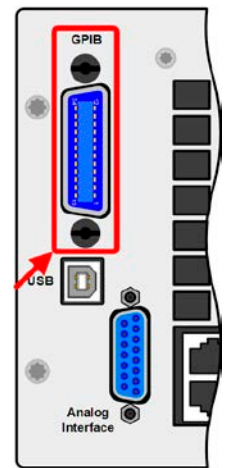

## 2. Installation & commissioning

### 2.1 Transport and storage

#### 2.1.1 Transport



- The handles on the front side of the device are **not** for carrying!
- Because of its weight, transport by hand should be avoided where possible. If unavoidable then only the housing should be held and not on the exterior parts (handles, DC terminal, rotary knobs).
- Do not transport when switched on or connected!
- When relocating the equipment use of the original packing is recommended
- The device should always be carried and mounted horizontally
- Use suitable safety clothing, especially safety shoes, when carrying the equipment, as due to its weight a fall can have serious consequences.

#### 2.1.2 Packaging

It's recommended to keep the complete transport packaging for the lifetime of the device for relocation or return to the manufacturer for repair. Otherwise the packaging should be disposed of in an environmentally friendly way.

#### 2.1.3 Storage

In case of long term storage of the equipment it's recommended to use the original packaging or similar. Storage must be in dry rooms, if possible in sealed packaging, to avoid corrosion, especially internal, through humidity.

## 2.2 Unpacking and visual check

After every transport, with or without packaging, or before commissioning, the equipment should be visually inspected for damage and completeness using the delivery note and/or parts list (see section „1.9.3. *Scope of delivery*“). An obviously damaged device (e. g. loose parts inside, damage outside) must under no circumstances be put in operation.

## 2.3 Installation

### 2.3.1 Safety procedures before installation and use



- The device may, according to model, have a considerable weight. Therefore the proposed location of the equipment (table, cabinet, shelf, 19" rack) must be able to support the weight without restriction.
- When using a 19" rack, rails suitable for the width of the housing and the weight of the device are to be used (see „1.8. *Technical Data*“)
- Before connecting to the mains ensure that the supply voltage is as shown on the product label. Overvoltage on the AC supply can cause equipment damage.
- Devices of this series feature an energy recovery function which, similar to solar energy equipment, feeds energy back into the local or public grid. Thus it must not be operated without adherence of directives from the local energy supply company and it must be investigated if there is requirement to install a grid and plant protection, before the installation or latest before initial commission!

## 2.3.2 Preparation

Mains connection for a device with a 2.5 kW power rating is done via the included 5 pole socket on the back of the device. Wiring of the included plug requires a 3 wire lead of suitable cross section and length. For recommendations about cable cross section see „2.3.4. Connection to AC supply“.



The device mustn't be operated on a standard wall socket. It requires a rigid connection to a properly fused supply point. See section 2.3.4.5 for the reason of this requirement.

Dimensioning of the DC wiring to the load/consumer has to reflect the following:



- The cable cross section should always be specified for at least the maximum current of the device.
- Continuous operation at the approved limit generates heat which must be removed, as well as voltage loss which depends on cable length and heating. To compensate for these the cable cross section should be increased and the cable length reduced.

## 2.3.3 Installing the device



- Select the location for the device so that the connection to the load or external source is as short as possible.
- Leave sufficient space behind the equipment for ventilation, at least 30 cm (1 ft).

A device in a 19" housing is designed to be installed in 19" racks or cabinets, which are either lockable or at least have closable doors. This is required to achieve a sufficient protection against touching parts leading dangerous voltage.

The device can rest on rails or a shelf. When selecting those the depth of the device and its weight must be taken into account. The handles on the front are intended to help sliding it in or out of the cabinet. Slots on the front plate are provided for fixing the device (fixing screws not included).

Acceptable and unacceptable installation positions:

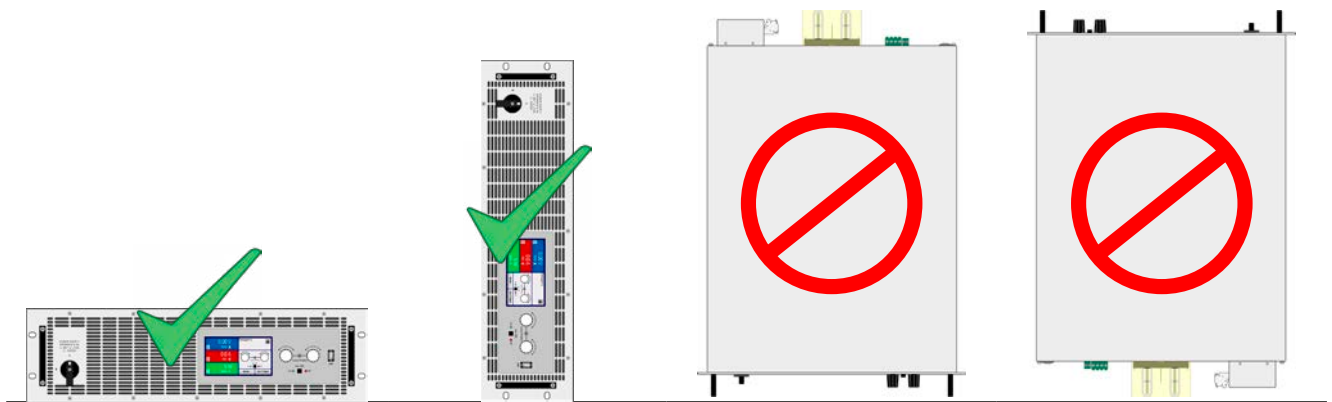

Standing surface

## 2.3.4 Connection to AC supply



- Connection to an AC supply must only be carried out by qualified personnel and the device must always be run directly on a power grid (transformer are permitted) and not on generators or UPS equipment!
- Cable cross section must be suitable for the maximum input current of the device! See tables below. The device should furthermore be fused externally and according to the current rating and cable cross section
- Before plugging the AC plug ensure that the device is switched off by its mains switch!
- Ensure that all regulations for the operation of the device and connection to the public grid of energy back-feeding equipment have been considered and requirements have been met!

The device is delivered with a 5 pole AC plug. That plug is connected either to a single-phase supply (L, N, PE) or two-phase supply with 208 V rating (2x L, PE).



The PE conductor is imperative and must always be wired!

### 2.3.4.1 Cross sections

For the selection of a suitable cable **cross section** the rated AC current of the device and the cable length are decisive. Based on the connection of a **single unit** the table below lists the maximum input current and recommended minimum cross section for each phase. The plug is labeled with L1, L2, L3 and PE, but only inputs L2 and L3 are used to supply the device. When using a single-phase supply, the input L3 will usually be connected to N. This assignment L3 = N is, however, not mandatory. The two phases can also be switched. It's only important to connecte the correct two inputs.

Nominal power	Input L1		Input L2		Input L3 / N		PE
	∅	I <sub>max</sub>	∅	I <sub>max</sub>	∅	I <sub>max</sub>	∅
2.5 kW	-	-	2,5 mm <sup>2</sup>	16 A	2,5 mm <sup>2</sup>	16 A	2,5 mm <sup>2</sup>

### 2.3.4.2 AC cable

The included connection plug can receive crimped cable ends of up to 6 mm<sup>2</sup>. The longer the connection cable, the higher the voltage loss due to the cable resistance. Therefore the mains cables should be kept as short as possible or have a bigger cross section.

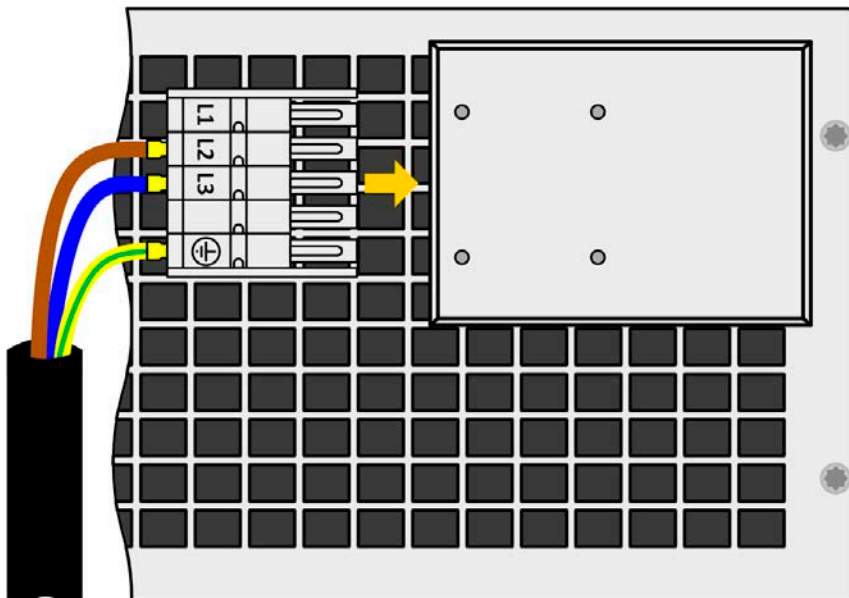

Figure 7 - Example for a mains cord (cable not included in delivery)

### 2.3.4.3 Strain relief and plug fixture

There is a standard fixture mounted to the AC input connection block on the rear. It's used to prevent the AC plug from loosening and disconnecting due to vibrations or similar. The fixture is also used as strain relief.

Using the 4x M3 acorn nuts, it's recommend to mount the fixture to the AC filter block every time the AC plug has been plugged again.

It's furthermore recommended to install the strain relief by using suitable cable straps (1 or 2 pcs, not included), as depicted in the figure to the right.

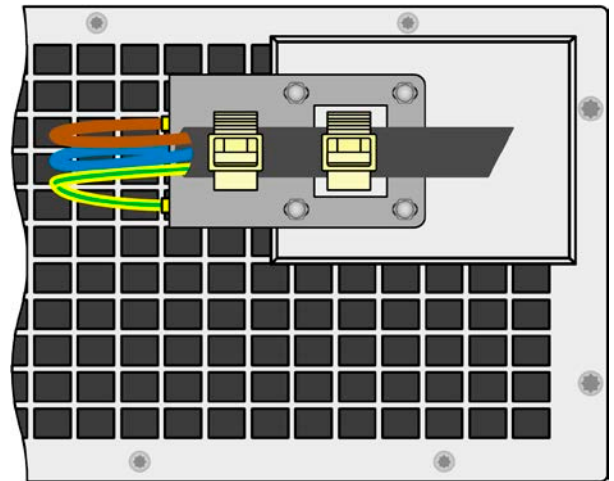

### 2.3.4.4 Connection variants

In a situation when multiple units are operated in parallel and there is a three-phase supply available, it should be used in order to distribute the phase load as equally as possible. The ideal setup would be three units or a multiple of three. Any number of units on the same connection point results in a different connection scheme. Here are a few example for comparison:

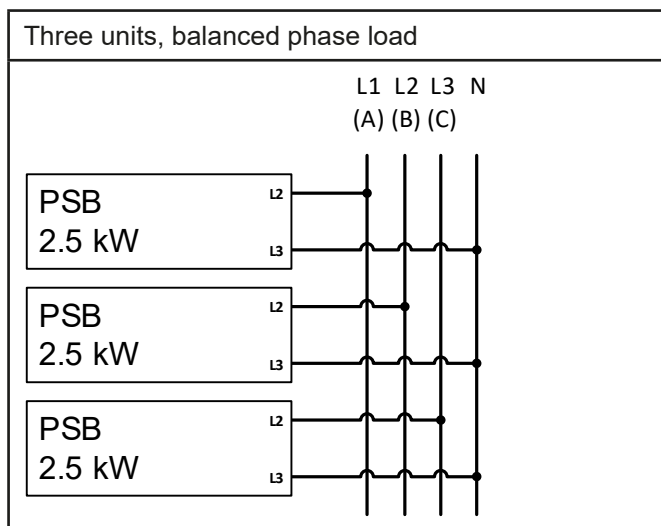
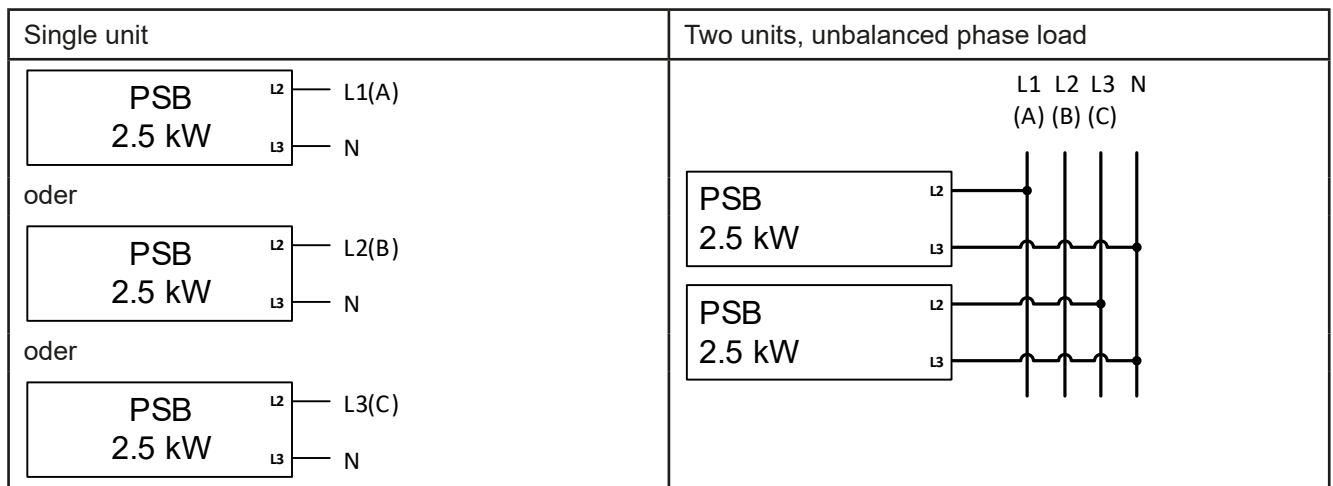

## 2.3.4.5 Protecting the electrical installation when using energy recovering devices

A PSB 9000 device recovers energy and feeds it back into the local power grid. The generated current adds to the grid current (see schematic below) and this can lead to an overload of the existing installation. Considering any two outlets, no matter of what kind they are, there is usually no extra fusing installed. In case of a defect in the AC part (i.e. short-circuit) of any consumer device or if there are multiple devices connected which could take a higher power, the total current could flow across wires which are not laid out for this higher current. It could lead to damage or even fire in the wires or connection points.

In order to avoid damages and accidents, the existing installation concept must be taken into regard before installing such recovering devices. Schematic depiction with 1 recovering device and consumers:

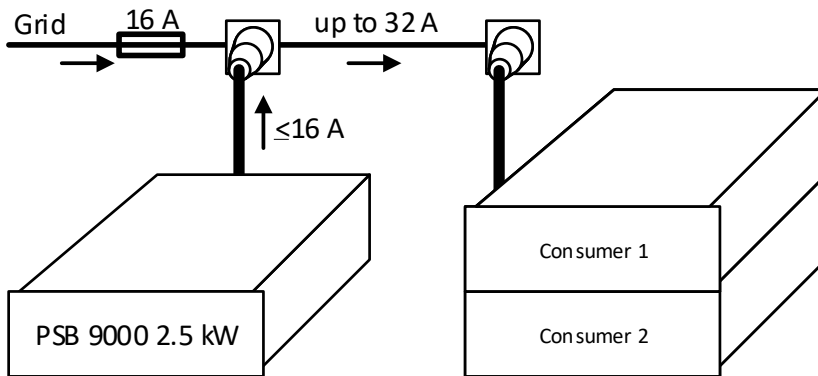

When running a higher number of recovering, i. e. energy backfeeding units on the same leg of the installation, the total currents per phase increases accordingly.

## 2.3.5 Connection to DC loads or DC sources



- In the case of a device with a high nominal current and hence a thick and heavy DC connection cable it's necessary to take account of the weight of the cable and the strain imposed on the DC connection. Especially when mounted in a 19" cabinet or similar, where the cable could hang on the DC terminal, a strain reliever should be used.
- Connection to and operation with transformerless DC-AC inverters (for example solar inverters) is restricted, because the inverter can shift the potential of negative DC pole against PE (ground). Mind the max. allowed potential shift (see technical specifications)!
- Due to the construction, the device will always draw a small current of  $\leq 0.1\% I_{Nom}$  when being connected to an external source and while the DC input is switched off!



**No false polarity protection inside! When connecting sources with false polarity the device will be damaged, also when not powered!**

The DC terminal is on the back side of the device and isn't protected by a fuse. The cross section of the connection cable is determined by the current consumption, cable length and ambient temperature.

For cables up to 1.5 m (4.9 ft) and average ambient temperature up to 50°C (122°F), we recommend:

up to **30 A**: 6 mm<sup>2</sup>                      up to **70 A**: 16 mm<sup>2</sup>  
 up to **90 A**: 25 mm<sup>2</sup>                      up to **120 A**: 35 mm<sup>2</sup>

**per connection pole** (multi-conductor, insulated, openly suspended). Single cables of, for example, 70 mm<sup>2</sup> may be replaced by e. g. 2x 35 mm<sup>2</sup> etc. If the cables are long then the cross section must be increased to avoid voltage loss and overheating.

### 2.3.5.1 DC terminal types

The table below shows an overview of the various DC terminals. It's recommended that connection of load cables always utilizes flexible cables with ring lugs.

Type 1: Models up to 360 V	Type 2: Models from 500 V
M8 bolt on a metal rail Recommendation: ring lug with a 8 mm hole	M6 bolt on a metal rail Recommendation: ring lug with a 6 mm hole

## 2.3.5.2 Cable lead and plastic cover

A plastic cover for contact protection is included for the DC terminal. It should always be installed. The cover for type 2 (see picture above) is fixed to the connector itself, for type 1 to the back of the device. Furthermore the cover for type 1 has break outs so that the supply cable can be laid in various directions.



*The connection angle and the required bending radius for the DC cable must be taken into account when planning the depth of the complete device, especially when installing in a 19" cabinet or similar. For type 2 connectors only a horizontal lead can be used to allow for installation of the cover.*

Examples of the type 1 terminal:

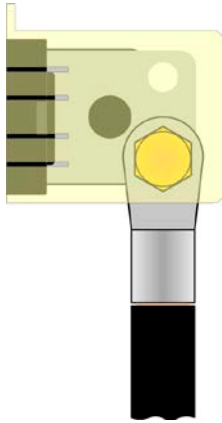

- 90° up or down
- space saving in depth
- no bending radius

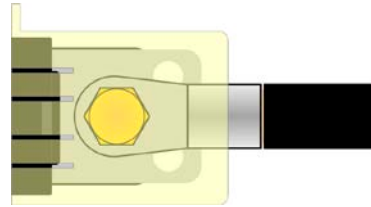

- horizontal lead
- space saving in height
- large bending radius

## 2.3.6 Grounding of the DC terminal

Grounding one of the DC terminal poles is permissible, but causes potential shift against PE on the opposite pole. Because of insulation, there is a max. allowed potential shift defined for the DC terminal poles, which depends on the device model. Refer to „1.8.3. Specific technical data“ for details.

## 2.3.7 Connecting the analog interface

The 15 pole connector (Type: Sub-D, D-Sub) on the rear side is an analog interface. To connect this to a controlling hardware (PC, electronic circuit), a standard plug is necessary (not included in the scope of delivery). It's generally advisable to switch the device completely off before connecting or disconnecting this connector, but at least the DC terminal.

## 2.3.8 Connection of remote sense



Both pins „NC“ of the Sense connector must not be wired!



- *Remote sensing is only effective during constant voltage operation (CV) and for other regulation modes the sense input should be disconnected, if possible, because connecting it generally increases the oscillation tendency*
- *The cross section of the sense cables is noncritical. Recommendation for cables up to 5 m (16 ft): use at least 0.5 mm<sup>2</sup>*
- *Sense cables should be not twisted and Sens- laid close to DC-, as well as Sense+ close to DC+ avoid or to damp oscillation that could occur. If necessary, an additional capacitor should be installed at the load / source or the DC terminal to eliminate oscillation*
- *The + sense cables must be connected to + on the load/source and - sense to - at the load/source, otherwise the sense input could be damaged. For an example see Figure 8 below.*
- *In master-slave operation, the remote sensing must be connected to the master unit only*



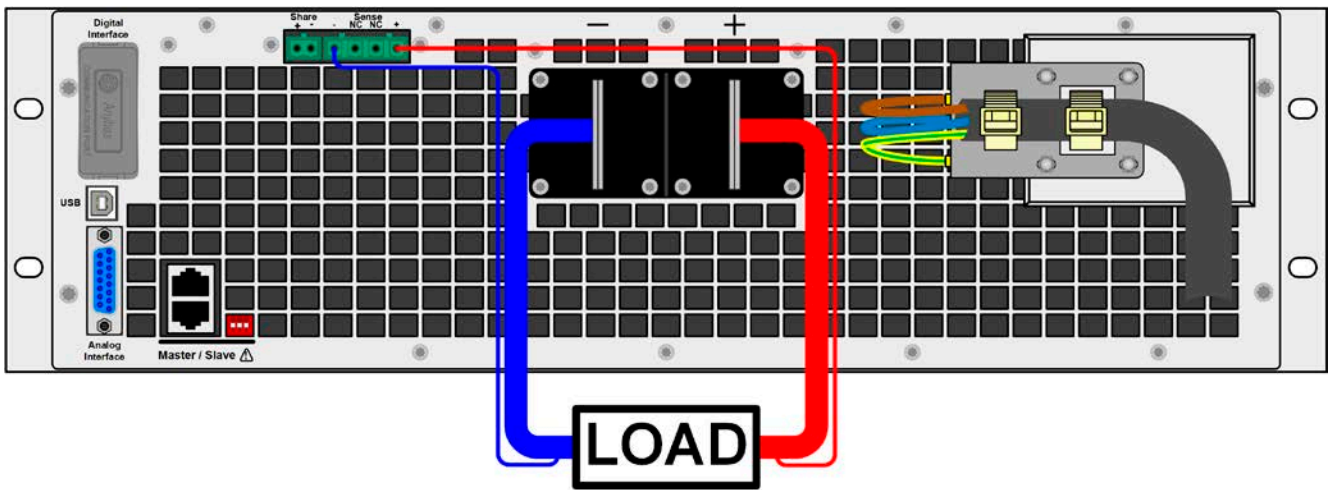

Figure 8 - Example for remote sensing wiring with load in source mode (sink mode will be wired identically)

### 2.3.9 Installation of an interface module

The optionally obtainable interface modules can be retrofitted by the user and are exchangeable with each other. The settings for the currently installed module vary and need to be checked and, if necessary, corrected on initial installation and after module exchange.



- Common ESD protection procedures apply when inserting or exchanging a module.
- The device must be switched off before insertion or removal of a module
- Never insert any other hardware other than an interface module into the slot
- If no module is in use it's recommended that the slot cover is mounted in order to avoid internal dirtying of the device and changes in the air flow.

Installation steps:

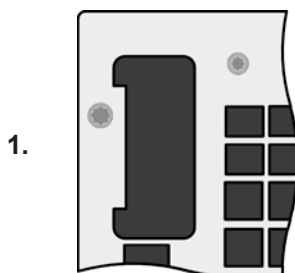

1. Remove the slot cover. If needed, use a screw driver.

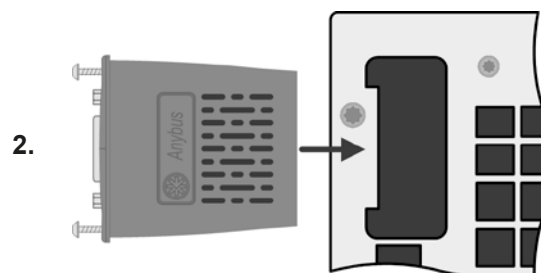

2. Insert the interface module into the slot. The shape ensures correct alignment.

When inserting take care that it's held as close as possible to a 90° angle to the rear wall of the device. Use the green PCB which you can recognize on the open slot as guide. At the end is a socket for the module.

On the bottom side of the module are two plastic nibs which must click into the green board (PCB) so that the module is properly aligned on the rear wall of the device.

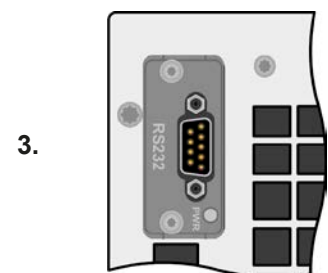

3. The screws (Torx 8) are provided for fixing the module and should be fully screwed in. After installation, the module is ready for use and can be connected.

Removal follows the reverse procedure. The screws can be used to assist in pulling out the module.

## 2.3.10 Connecting the “Share” bus

The “Share” bus connector on the back side is usually connected to the Share bus connectors of further units of series PSB 9000, in order to balance the current between multiple units in parallel operation, especially when using the integrated function generator of the master unit. For further information about parallel operation refer to section „3.12.1. *Parallel operation in master-slave (MS)*“.

For the connection of the share bus the following must be paid attention to:



- Connection is only permitted between compatible devices (see „1.9.10. “Share” connector“ for details) and between a max. of 16 units
- When not using one or several units of a system configured with Share bus, because less power is required for an application, it's recommended to disconnect the unit's from the Share bus, because even when not powered they can have a negative impact on the control signal on the bus due to their impedance. Disconnection can be done by simply unplugging them from the bus or using switches in the positive line.
- The Share bus of this series works in two directions, for source and sink mode. It's compatible to a few other device series, but it requires careful planning of the entire system, if devices are going to be connected which solely work as sink (el. load) or as source (power supply).

## 2.3.11 Connecting the USB port (rear side)

In order to remotely control the device via this port, connect the device with a PC using the included USB cable and switch the device on.

### 2.3.11.1 Driver installation (Windows)

On the initial connection with a PC the operating system will identify the device as new hardware and will try to install a driver. The required driver is for a Communications Device Class (CDC) device and is usually integrated in current operating systems such as Windows 7 or 10. But it's strongly recommended to use the included driver installer (on USB stick) to gain maximum compatibility of the device to our softwares.

### 2.3.11.2 Driver installation (Linux, MacOS)

We can't provide drivers or installation instructions for these operating systems. Whether a suitable driver is available is best carried out by searching the Internet.

### 2.3.11.3 Alternative drivers

In case the CDC drivers described above are not available on your system, or for some reason do not function correctly, commercial suppliers can help. Search the Internet for suppliers using the keywords “cdc driver windows“ or “cdc driver linux“ or “cdc driver macos“.

## 2.3.12 Initial commission

For the first start-up after installation of the device, the following procedures have to be executed:

- Confirm that the connection cables to be used are of a satisfactory cross section!
- Check if the factory settings of set values, safety and monitoring functions and communication are suitable for your intended application of the device and adjust them if required, as described in the manual!
- In case of remote control via PC, read the additional documentation for interfaces and software!
- In case of remote control via the analog interface, read the section in this manual concerning analog interfaces!

## 2.3.13 Commission after a firmware update or a long period of non-use

In case of a firmware update, return of the equipment following repair or a location or configuration change, similar measures should be taken to those of initial start up. Refer to „2.3.12. *Initial commission*“.

Only after successful checking of the device as listed may it be operated as usual.

## 3. Operation and application

### 3.1 Terms

The device is a combination of a power supply and an electronic load. It can work alternatingly in one of two superior operation modes which are distinguished from each other in several parts of this document below:

- **Source / source mode:**
  - the device works as a power supply, generating and providing DC voltage to an external DC load
  - in this mode, the DC terminal is considered as DC output
- **Sink / sink mode:**
  - the device works as an electronic load, sinking DC energy from an external DC source
  - in this mode, the DC terminal is considered as DC input

### 3.2 Important notes

#### 3.2.1 Personal safety



- In order to guarantee safety when using the device, it's essential that only persons operate the device who are fully acquainted and trained in the required safety measures to be taken when working with dangerous electrical voltages
- For models which can generate a voltage which is dangerous by contact, or is connected to such, the included DC terminal cover, or an equivalent, must always be used
- Read and follow all safety warnings in section 1.7.1!

#### 3.2.2 Genera



- When running the device in source mode, unloaded operation isn't considered as a normal operation mode and can thus lead to false measurements, for example when calibrating the device
- The optimal working point of the device is between 50% and 100% voltage and current
- It's recommended to not run the device below 10% voltage and current, in order to make sure technical values like ripple and transient times can be met

## 3.3 Operating modes

A power supply is internally controlled by different control or regulation circuits, which shall bring voltage, current and power to the adjusted values and hold them constant, if possible. These circuits follow typical laws of control systems engineering, resulting in different operating modes. Every operating mode has its own characteristics which is explained below in short form.

### 3.3.1 Voltage regulation / Constant voltage

Voltage regulation is also called constant voltage operation (**CV**).

The voltage on the DC terminal of the device is held constant on the adjusted value, unless the current or the power according to  $P = U_{DC} \cdot I$  reaches the adjusted current or power limit. In both cases the device will automatically change to constant current or constant power operation, whatever occurs first. Then the voltage can't be held constant anymore and will sink (in source mode) or rise (in sink mode) to a value resulting from Ohm's law.

CV is available for both, sink and source mode, and primarily depends on the relation between voltage set value and voltage level on the DC terminal. The device will switch between both modes seamless when adjusting voltage. In source mode, the output voltage in CV mode is equal to the setting while in sink mode the setting must always be lower than the input voltage in order to have the device draw current.

While the DC power stage is switched on and constant voltage mode is active, the condition "CV mode active" will be indicated on the graphics display by the abbreviation **CV** and this message will be passed as a signal to the analog interface, as well stored as status which can also be read as a status message via digital interface.

#### 3.3.1.1 Transient time after load step (source mode)

For constant voltage mode (CV), the technical date "Transient time after load step" (see 1.8.3) defines a time that is required by the internal voltage regulator of the device to settle the voltage (in source mode) after a load step. Negative load steps, i.e. high load to lower load, will cause the output voltage to overshoot for a short time until compensated by the voltage regulator.

The same occurs with a positive load step, i.e. low load to high load. There the output collapses for a moment. The amplitude of the overshoot or collapse depends on the device model, the currently adjusted output voltage and the capacity on the DC terminal and can thus not be stated with a specific value.

Depictions:

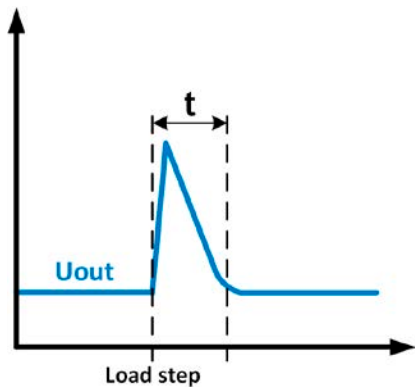

Example for neg. load step: the DC output voltage will rise above the adjusted value for a short time.  $t$  = transient time to settle the output voltage.

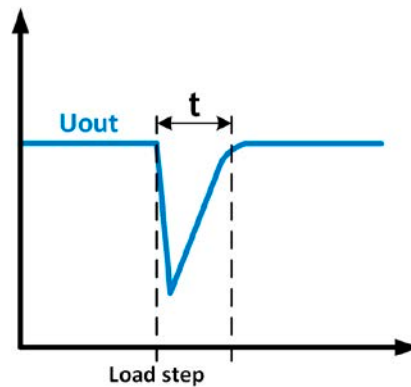

Example for pos. load step: the DC output voltage will collapse below the adjusted value for a short time.  $t$  = transient time to settle the output voltage.

### 3.3.2 Current regulation / constant current / current limiting

Current regulation is also known as current limiting or constant current mode (**CC**).

The current in the DC terminal of the device is held constant once the output current (source mode) to the load or the current consumed from the load (sink mode) reaches the adjusted limit. Then the device automatically switches to CC. In source mode, the current flowing from the power supply is only determined by the output voltage and the load's true resistance.

As long as the output current is lower than the adjusted current limit, the device will be either in constant voltage or constant power mode. If, however, the power consumption reaches the set maximum power value, the device will switch automatically to power limiting and set voltage and current according to  $P = U \cdot I$ .

While the DC power stage is switched on and constant current mode is active, the condition "CC mode active" will be indicated on the graphics display by the abbreviation **CC** and this message will be passed as a signal to the analog interface, as well stored as status which can also be read as via digital interface.

### 3.3.3 Power regulation / constant power / power limiting

Power regulation, also known as power limiting or constant power (**CP**), keeps the DC power constant if the current flowing to the load (source mode) or the current from the source (sink mode) in relation to the voltage reaches the adjusted limit according to  $P = U \cdot I$  (sink mode) or  $P = U^2 / R$  (source mode).

In source mode, the power limiter then regulates the output current according to  $I = \sqrt{P / R}$ , where  $R$  is the load's resistance.

Power limiting operates according to the auto-range principle such that at lower voltages higher current can flow and vice versa, always in order to maintain constant power within the range  $P_N$  (see diagram to the right).

While the DC power stage is switched on and constant power mode is active, the condition "CP mode active" will be indicated on the graphics display by the abbreviation **CP**, as well stored as status which can also be read as a status message via digital interface.

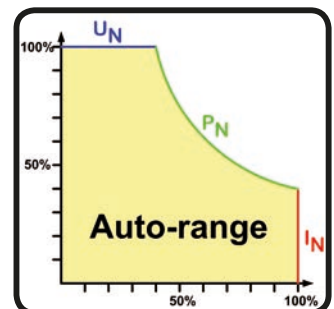

*When using remote sensing in source mode, the device usually delivers a higher voltage on the DC output than adjusted, which results in an additional power due to line losses and may cause the device to enter power limitation without explicitly indicating "CP" in the display. In sink mode, the CP status is correctly displayed for the power consumed from the source.*

### 3.3.4 Internal resistance regulation (source mode)

Internal resistance control (short: CR) of power supplies is the simulation of a virtual internal resistor which is in series to the load. According to Ohm's law, this resistance causes a voltage drop, which will result in a difference between the adjusted output voltage and the actual output voltage. This will also work in CC or CP mode whereas the actual output voltage will differ even more from the adjusted voltage, because both modes limit the output voltage additionally.

The adjustable resistance range of a particular model is given in the technical specifications. The voltage regulation in dependency of the resistance set value and the output current is done by calculation in a fast ARM controller, being only a little slower than other controllers inside the control circuit. Clarification:

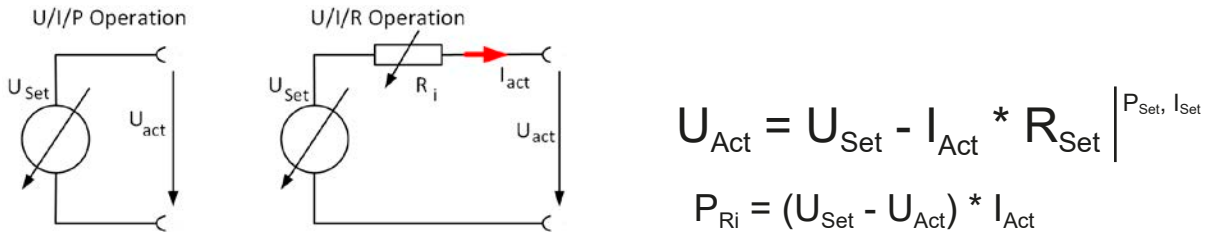

With resistance mode being activated the function generator will be unavailable and the actual power value provided by the device does not include the simulated power dissipation of  $R_i$ .

### 3.3.5 Resistance regulation / constant resistance (sink mode)

In sink mode, when the device is working as electronic load, the operating principle is based on a variable internal resistance. Constant resistance mode (CR) is sort of a natural attribute of a load. It attempts to set the internal resistance to the user defined value by adjusting the input current depending on the measured input voltage according to formula  $I_{IN} = U_{IN} / R_{SET}$ , which is derived from Ohm's law.

With series PSB 9000, the difference between an external voltage supplied to the device and the set value of voltage determines the true current. There are two situations:

a) *The voltage on the DC input is higher than the voltage set value*

In this situation, the above formula extends to  $I_{IN} = (U_{IN} - U_{SET}) / R_{SET}$ .

An example: the supplied voltage on the DC input is 200 V, the resistance  $R_{SET}$  is adjusted to 10  $\Omega$  and the voltage set value  $U_{SET}$  is set to 0 V. When switching the DC input on the current should go to 20 A and the actual resistance  $R_{MON}$  should show approx. as 10  $\Omega$ . When adjusting the voltage set value  $U_{SET}$  to 100 V now, the current would lower to 10 A while the actual resistance  $R_{MON}$  should remain at 10  $\Omega$ .

b) *The voltage on the DC input is equal to or lower than the voltage set value*

The PSB 9000 would not draw any current and enter CV mode. In a situation where the supplied input voltage is approx. equal to or oscillating around the voltage set value, the sink mode would permanently toggle between CV and CR. It's thus not advised to adjust the voltage set value to the same level as the external source.

The internal resistance is naturally limited between almost zero and maximum, where the resolution of current regulation becomes very inaccurate. Because the internal resistance can't have a value of zero, the lower limit is defined to an achievable minimum. This ensures that the internal electronic load, at very low input voltages, can consume a high input current from the source, up to the adjusted current set value.

While the DC input is switched on and constant resistance mode is active, the condition "CR mode active" will be indicated on the graphics display by the abbreviation CR, as well it will be stored as internal status that can be read via digital interface.

## 3.3.6 Sink-source mode switching

The switchover between sink and source mode happens automatically and only depends on the device's voltage setting and actual value on the DC terminal or the remote sense connector, if in use.

It means, that when connecting an external voltage source to the DC terminal, only the voltage set value determines the operation mode. When connecting a load which can't generate a voltage, only source mode can be run.

Rules for applications with external voltage source connected:

- If the voltage set value is higher than the actual voltage of the external source, the device will run in source mode
- If the voltage set value is lower, it will run in sink mode

To run one of both modes explicitly, i.e. without automatic switchover, it would require following:

- for "source only mode" adjust the current set value for the sink to 0
- for "sink only mode" adjust the voltage set value to 0

## 3.3.7 Dynamic characteristics and stability criteria

When working in sink mode, the device becomes an electronic load which is characterised by short rise and fall times of the current, which are achieved by a high bandwidth of the internal regulation circuit.

In case of testing sources with own regulation circuits at the load, like for example power supplies, a regulation instability may occur. This instability is caused if the complete system (feeding source and electronic load) has too little phase and gain margin at certain frequencies. 180 ° phase shift at > 0dB amplification fulfils the condition for an oscillation and results in instability. The same can occur when using sources without own regulation circuit (eg. batteries), if the connection cables are highly inductive or inductive-capacitive.

The instability isn't caused by a malfunction of the load, but by the behavior of the complete system. An improvement of the phase and gain margin can solve this. In practice, a capacity is directly connected to the DC input, perhaps alternatively to the remote sense input, if connected to the source. The value to achieve the expected result isn't defined and has to be found out. We recommend:

60/80 V models: 1000uF...4700uF

200/360 V models: 100uF...470uF

500 V model: 47uF...150uF

750 V model: 22uF...100uF

## 3.4 Alarm conditions



*This section only gives an overview about device alarms. What to do in case your device indicates an alarm condition is described in section „3.7. Alarms and monitoring“.*

As a basic principle, all alarm conditions are signaled optically (text + message in the display) and acoustically (if activated), as well as status via digital interface. In addition, the alarms are reported as signals on the analog interface. For later acquisition, an alarm counter can also be shown on display or read via digital interface.

### 3.4.1 Power Fail

Power Fail (PF) indicates an alarm condition which may have various causes:

- AC input voltage too low (mains undervoltage, mains failure)
- Defect in the input circuit (PFC)
- One or multiple power stages in the device are faulty

As soon as a power fail occurs, the device will stop to supply or sink power and switch off the DC terminal. The condition of the DC terminal after a PF alarm occurred during normal operation can be set up. See „3.5.3. Configuration via MENU“, parameter “DC terminal after PF alarm”.



*Switching off the device by the mains switch can't be distinguished from a mains blackout and thus the device will signalize a PF alarm every time it's switched off. This can be ignored.*

### 3.4.2 Overtemperature

An overtemperature alarm (OT) can occur from an excess temperature inside the device and temporarily causes it to switch of the power stage(s). This can occur if the ambient temperature exceeds the maximum ambient temperature rating for the device. After cooling down, the device can automatically switch the power stage back on, depending on the setting of parameter “DC terminal after OT alarm”. See section 3.5.3.1.

### 3.4.3 Overvoltage protection

An overvoltage alarm (OVP) will switch off the DC power stage and can occur if:

- the device itself, when running in source mode, or an external source (in sink mode) brought a voltage to the DC terminal higher than set for the overvoltage alarm threshold (OVP, 0...110%  $U_{Nom}$ ) or the connected load somehow returns voltage higher than this threshold
- the OVP threshold has been adjusted too close above the output voltage in source mode and if the device is in CC regulation mode and then experiences a negative load step, it will make the voltage rise quickly, resulting in an voltage overshoot for a short moment which can already trigger the OVP

This function serves to warn the user acoustically or optically that the device probably has generated or experienced an excessive voltage which could damage the connected load application or the device.



- The device isn't fitted with protection from external overvoltage and could even be damaged when not powered
- The changeover from operation modes CC -> CV in source mode can cause voltage overshoots

### 3.4.4 Overcurrent protection

An overcurrent alarm (OCP) will switch off the DC power stage and can occur if:

- the current in the DC terminal reaches the adjusted OCP limit.

This function serves to protect the connected load application (source mode) or the external source (sink mode) so it this isn't overloaded and possibly damaged due to an excessive current.

### 3.4.5 Overpower protection

An overpower alarm (OPP) will switch off the DC terminal and can occur if:

- the product of the voltage and current in the DC terminal reaches the adjusted OPP limit.

This function serves to protect the connected load application (source mode) or the external source (sink mode) so that this isn't overloaded and possibly damaged due to an excessive power.

## 3.4.6 Safety OVP

This extra feature is **only built into the 60 V model** of this series. Similar to the regular overvoltage protection (OVP, see 3.4.3), the Safety OVP is supposed to protect the application or people according to SELV. The alarm shall prevent the device from providing an output voltage higher than 60 V. However, the alarm could also be triggered by an external source providing an excess voltage to the DC input of the device.

A safety OVP alarm can occur if

- the voltage on the DC of the device reaches the rigid threshold of 60.6 V.

If the voltage on the DC terminal exceeds that level for any reason, the DC terminal will be switched off and alarm "Safety OVP" will be indicated in the display. This alarm can't be acknowledged the usual way. It requires to power-cycle the unit.



*During normal operation of the power supply, this alarm shouldn't trigger. There are, however, situations which can trigger the alarm, like when working with voltages close to the threshold of 60.6 V or voltage spikes when leaving CC mode when the current was 0 A before.*



When remote sensing is used, i. e. the rear input "Sense" is connected, the true output voltage (source mode) is higher than set value so the Safety OVP could already trigger at voltage settings lower than 60 V.



## 3.5 Manual operation

### 3.5.1 Switching on the device

The device should, as far as possible, always be switched on using the rotary switch on the front of the device. Alternatively this can take place using an external cutout (contactor, circuit breaker) of suitable current capacity.

After switching on, the display will first show some device related information (model, firmware versions etc.) and then a language selection screen for 3 seconds. A few seconds later it will show the main screen.

In setup (see section „3.5.3. Configuration via MENU“ in the second level menu “**General settings**” is an option “**DC terminal after power ON**” in which the user can determine the condition of the DC power stage after power-up. Factory setting here is “**OFF**”, meaning that the DC power stage on power-up are always switched off. “**Restore**” means that the last condition will be restored, either on or off. All set values are always saved and restored.



*For the time of the start phase the analog interface can signal undefined statuses on the output pins such as ALARMS 1 or ALARMS 2. Those signals must be ignored until the device has finished booting and is ready to work.*

### 3.5.2 Switching off the device

On switch-off the last condition of the power stage and the most recent set values are saved. Furthermore, a PF alarm (power failure) will be reported, but can be ignored.

The DC power stage is immediately switched off and after a short while fans will shut down and after another few seconds the device will be completely powered off.

### 3.5.3 Configuration via MENU

The MENU serves to configure all operating parameters which are not constantly required. These can be set by finger touch on the MENU touch area, but only if the DC terminal is switched OFF. See figure to the right.

While the DC terminal is switched on the settings menu will not be shown, but some status information.

Menu navigation is also done by finger touch. Values are set using the rotary knobs. The assignment of the knobs to the adjustable values isn't indicated in menu pages, but there is an assignment rule: upper value -> left-hand knob, lower values -> right-hand knob.

Some setting parameters are self-explanatory, others are not. The latter will be explained on the pages following.

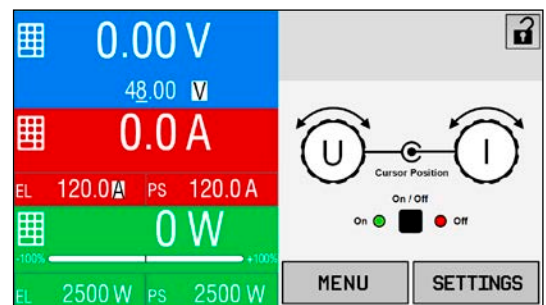

## 3.5.3.1 Menu “General Settings”

Setting	Description
<b>Allow remote control</b>	Selection “ <b>NO</b> ” means that the device can’t be remotely controlled over either the digital or analog interfaces. If remote control isn’t allowed, the status will be shown as “ <b>local</b> ” in the status area on the main display. See also section 1.9.6.1
<b>Analog interface range</b>	Selects the voltage range for the analog set values, actual values and reference voltage output. <ul style="list-style-type: none"> <li>• <b>0...5 V</b> = Range is 0...100% set /actual values, reference voltage 5 V</li> <li>• <b>0...10 V</b> = Range is 0...100% set /actual values, reference voltage 10 V</li> </ul> Also see „3.6.4. Remote control via the analog interface (AI)“
<b>Analog interface Rem-SB</b>	Selects how the input pin “Rem-SB” of the analog interface shall be working regarding levels (see „3.6.4.4. Analog interface specification“) and logic: <ul style="list-style-type: none"> <li>• <b>Normal</b> = Levels and function as described in the table in 3.6.4.4</li> <li>• <b>Inverted</b> = Levels and function will be inverted</li> </ul> Also see „3.6.4.7. Application examples“
<b>Analog Rem-SB action</b>	Selects what action is transferred to the DC power stage when changing the level of analog input “Rem-SB”: <ul style="list-style-type: none"> <li>• <b>DC OFF</b> = the pin can only switch the DC power stage off</li> <li>• <b>DC AUTO</b> = the pin can switch the DC power stage off and on again, if it has been switched on before from a different control location</li> </ul>
<b>Analog interface pin 6</b>	Pin 6 of the analog interface (see section 3.6.4.4) is by default assigned to only signal the device alarms OT and PF. This parameter allows to also enable signaling only one of both (3 possible combinations): <p><b>Alarm OT</b> = Enable/disable signaling of alarm OT on pin 6</p> <p><b>Alarm PF</b> = Enable/disable signaling of alarm PF on pin 6</p>
<b>Analog interface pin 14</b>	Pin 14 of the analog interface (see section 3.6.4.4) is by default assigned to only signal the device alarm OVP. This parameter allows to also enable signaling further device alarms (7 possible combinations): <p><b>Alarm OVP</b> = Enable/disable signaling of alarm OVP on pin 14</p> <p><b>Alarm OCP</b> = Enable/disable signaling of alarm OCP on pin 14</p> <p><b>Alarm OPP</b> = Enable/disable signaling of alarm OPP on pin 14</p>
<b>Analog interface pin 15</b>	Pin 15 of the analog interface (see section 3.6.4.4) is by default assigned to only signal the regulation mode CV. This parameter allows to enable signalling a different device status (2 options): <p><b>Regulation mode</b> = Enable/disable signaling of CV reg mode on pin 15</p> <p><b>DC status</b> = Enable/disable signaling of DC terminal status on pin 15</p>
<b>DC terminal after OT alarm</b>	Determines how the DC power stages shall react after an overtemperature (OT) alarm has occurred and the power stages have cooled down again: <ul style="list-style-type: none"> <li>• <b>OFF</b> = DC power stage(s) will be off</li> <li>• <b>AUTO</b> = The device will automatically restore the situation before the OT alarm, which usually means the DC power stage(s) to be on</li> </ul>
<b>DC terminal after power ON</b>	Determines the condition of the DC power stage after power-up. <ul style="list-style-type: none"> <li>• <b>OFF</b> = DC power stage is always off after switching on the device.</li> <li>• <b>Restore</b> = DC power stage condition will be restored to the same condition prior to switch off.</li> </ul>
<b>DC terminal after PF alarm</b>	Determines how the DC power stage shall react after a power fail (PF) alarm has occurred: <ul style="list-style-type: none"> <li>• <b>OFF</b> = DC power stage will be switched off and remains until user action</li> <li>• <b>AUTO</b> = DC power stage will switch on again after the PF alarm cause is gone and if it was switched on before the alarm occurred</li> </ul>

Setting	Description
<b>DC terminal after remote</b>	Determines the condition of the DC terminal after leaving remote control either manually or by command: <ul style="list-style-type: none"> <li>• <b>OFF</b> = DC terminal will be always off when switching from remote to manual</li> <li>• <b>AUTO</b> = DC terminal will keep the last condition</li> </ul>
<b>Enable R mode</b>	Activates (“ <b>Yes</b> ”) or deactivates (“ <b>No</b> ”) the internal resistance control. If activated, the resistance set value can be adjusted on the main screen as additional value. For details refer to „3.3.4. <i>Internal resistance regulation (source mode)</i> “.
<b>USB file separator format</b>	Switches the decimal point format of values and also the CSV file separator for USB logging and for other features where CSV files are used. <p><b>US</b> = Comma separator (US standard for CSV files)  <b>Default</b> = Semicolon separator (german/european standard for CSV files)</p>
<b>USB logging with units (V,A,W)</b>	CSV files generated from USB logging by default add physical units to values. This can be deactivated by setting this option to “ <b>No</b> ”.
<b>Reset device to defaults</b>	Touch area “ <b>Start</b> ” will initiate a reset of all settings (HMI, profile etc.) to factory default.
<b>Restart device</b>	Will initiate a warm start of the device.
<b>Master-slave mode</b>	Selecting “ <b>MASTER</b> ” or “ <b>SLAVE</b> ” enables the master-slave mode (MS) and sets the selected position for the unit in the MS system. For details see section „3.12.1. <i>Parallel operation in master-slave (MS)</i> “.
<b>Repeat master init.</b>	Touch area “ <b>Initialize</b> ” will repeat the initialisation of the master-slave system in case the automatic enumeration of the slave units by the master is once unsuccessful so the system would have less total power than expected or has to be repeated manually in case the master unit couldn't detect a missing slave

### 3.5.3.2 Menu “User Events”

See „3.7.2.1 *User defined events*“ on page 58.

### 3.5.3.3 Menu “Profiles”

See „3.10 *Loading and saving a user profile*“ on page 60.

### 3.5.3.4 Menu “Overview”

This menu page displays an overview of the set values (U, I, P or U, I, P, R) and alarm settings as well as settings limits. These can only be displayed, not changed.

### 3.5.3.5 Menu “About HW, SW...”

This menu page displays an overview of device relevant data such as serial number, article number etc., as well as an alarm history which lists the number of device alarms that probably occurred since the device has been powered.

### 3.5.3.6 Menu “Function Generator”

See „3.11 *The function generator*“ on page 61.

### 3.5.3.7 Menu “Communication”

This sub menu offers settings for digital communication via the optional or built-in interface. The button for the installed interface module or the optional GPIB port opens one or more settings pages, depending on the interface in use. There is furthermore an adjustable communication timeout, to make it possible to successfully transfer fragmented messages (data packets) using higher values. In the screen for “Com Protocols” you can enable both or disable one of the two supported communication protocols, ModBus and SCPI. This can help to avoid mixing both protocols and to receive unreadable messages, for example when expecting a SCPI response and getting a ModBus response instead.



For all Ethernet interfaces with two ports: „P1“ is related to port 1 and „P2“ to port 2, like printed on the module face. Two-port interfaces will use one IP only.

IF	Level 1	Description
<b>GPIB</b>	<b>Node Address</b>	Adjustment of the GPIB node address (only with option 3W installed) in the range 1...30

IF	Level 1	Description
Profibus DP	<b>Node Address</b>	Selection of the Profibus or node address of the device within range 1...125 via direct input
	<b>Function Tag</b>	String input box for a user-definable text which describes the Profibus slave function tag. Max. length: 32 characters
	<b>Location Tag</b>	String input box for a user-definable text which describes the Profibus slave location tag. Max. length: 22 characters
	<b>Installation Date</b>	String input box for a user-definable text which describes the Profibus slave installation date tag. Max. length: 40 characters
	<b>Description</b>	String input box for a user-definable text which describes the Profibus slave. Max. length: 54 characters

IF	Level 1	Level 2	Level 3	Description	
Ethernet / ModBus-TCP, 1 & 2 Port	<b>IP Settings 1</b>	<b>DHCP</b>		The IF allows a DHCP server to allocate an IP address, a subnet mask and a gateway. If no DHCP server is in the network then network parameters will be set as defined in item "Manual"	
		<b>Manual</b>	<b>IP address</b>	This option is activated by default. An IP address can be manually allocated.	
			<b>Gateway</b>	Here a gateway address can be allocated if required..	
			<b>Subnet mask</b>	Here a subnet mask can be defined if the default subnet mask isn't suitable.	
		<b>DNS address 1</b>	Here the addresses of the first and second Domain Name Servers (DNS) can be defined, if needed.		
		<b>DNS address 2</b>			
		<b>Port</b>	Range: 0...65535. Default ports: <b>5025</b> = Modbus RTU (all Ethernet interfaces) Reserved ports which must not be set with this parameter: <b>502</b> = Modbus TCP (Modbus-TCP interface only) other typical reserved ports		
	<b>IP Settings 2-P1</b>	<b>AUTO</b>		Settings for the Ethernet port such as transmission speed are set automatically.	
	<b>IP Settings 2-P2</b>	<b>Manual</b>	<b>Half duplex</b>	Manual selection for transmission speed (10MBit/100MBit) and duplex mode (full/half). It's recommended to use the "AUTO" option and only revert to "Manual" if these parameters fail. Different Ethernet port settings for 2-port modules are possible, as these include an Ethernet switch	
			<b>Full duplex</b>		
			<b>10MBit</b>		
			<b>100MBit</b>		
	<b>Host name</b>			Free choice of host name (default: Client)	
	<b>Domain name</b>			Free choice of Domain (default: Workgroup)	
	<b>TCP Keep-Alive</b>	<b>Enable TCP keep-alive</b>			

IF	Level 1	Description
Profinet/IO, 1 & 2 Port	<b>Host name</b>	Free choice of host name (default: Client)
	<b>Domain name</b>	Free choice of Domain (default: Workgroup)
	<b>Function Tag</b>	String input box for a user-definable text which describes the Profinet slave function tag. Max. length: 32 characters
	<b>Location Tag</b>	String input box for a user-definable text which describes the Profinet slave location tag. Max. length: 22 characters
	<b>Station Name</b>	String input box for a user-definable text which describes the Profinet station name. Max. length: 200 characters
	<b>Description</b>	String input box for a user-definable text which describes the Profibus slave. Max. length: 54 characters
	<b>Installation Date</b>	String input box for a user-definable text which describes the Profibus slave installation date tag. Max. length: 40 characters

IF	Level 1	Level 2	Description
CANopen	<b>Node Address</b>		Selection of the CANopen node address in the range 1...127
	<b>Baud Rate</b>	<b>AUTO</b>	Automatic detection of the bus baud rate.(speed)
		<b>LSS</b>	Automatically sets baud rate and node address
		<b>Manual</b>	Manual selection of the baud rate that is used by the CANopen interface. Possible selections: 10 kbps, 20 kbps, 50 kbps, 100 kbps, 125 kbps, 250 kbps, 500 kbps, 800 kbps, 1Mbps (1Mbps = 1 Mbit/s, 10 kbps = 10 kbit/s)

IF	Ebene 1	Level 2	Level 3	Description		
CAN	<b>Base ID</b>			Setup of the CAN base ID (11 Bit or 29 Bit, hex format). Default: <b>0h</b>		
	<b>Baud Rate</b>			Setup of the CAN bus speed or baud rate in typical value between 10 kbps and 1Mbps. Default: <b>500 kbps</b>		
	<b>Termination</b>			Activates or deactivates CAN bus termination with a built-in resistor. Default: <b>OFF</b>		
	<b>Broadcast ID</b>			Setup of the CAN broadcast ID (11 Bit or 29 Bit, hex format). Default: <b>7ffh</b>		
	<b>ID Format</b>			Selection of the CAN ID format between <b>Base</b> (11 Bit ID, 0h...7ffh) and <b>Extended</b> (29 Bit, 0h...1fffffffh)		
	<b>Cyclic Communication</b>	<b>Base ID Cyclic Read</b>			Setup of the CAN base ID (11 Bit or 29 Bit, hex format) for cyclic read of up to 5 object groups (see " <b>Cyclic Read Timing</b> "). The device will automatically send specific object data to the IDs defined with this setting. For more information refer to the programming guide. Default: <b>100h</b>	
			<b>Base ID Cyclic Send</b>		Setup of the CAN base ID (11 Bit or 29 Bit, hex format) for cyclic send of the three set values for U, I and P along with status in one single message. For more information refer to the programming guide. Default: <b>200h</b>	
		<b>Cyclic Read Timing (PS)</b>	<b>Status</b>			Activation/deactivation and time setting for the cyclic read of status from the adjusted „ <b>Base ID Cyclic Read</b> “ Range: 20...5000 ms. Default: 0 (deactivated)
			<b>Actual val.</b>			Activation/deactivation and time setting for the cyclic read of actual values from the adjusted „ <b>Base ID Cyclic Read + 1</b> “ Range: 20...5000 ms. Default: 0 (deactivated)
			<b>Set val.</b>			Activation/deactivation and time setting for the cyclic read of set values of U & I (source mode) from the adjusted „ <b>Base ID Cyclic Read + 2</b> “. Range: 20...5000 ms. Default: 0 (deactivated)
			<b>Limits 1</b>			Activation/deactivation and time setting for the cyclic read of adjustment limits of U & I (source mode) from the adjusted „ <b>Base ID Cyclic Read + 3</b> “. Range: 20...5000 ms. Default: 0 (deactivated)
			<b>Limits 2</b>			Activation/deactivation and time setting for the cyclic read of adjustment limits of P & R (source mode) to the adjusted „ <b>Base ID Cyclic Read + 4</b> “. Range: 20...5000 ms. Default: 0 (deactivated)
		<b>Cyclic Read Timing (EL)</b>	<b>Set val.</b>			Activation/deactivation and time setting for the cyclic read of set values of I, P and R (sink mode) from the adjusted „ <b>Base ID Cyclic Read + 5</b> “. Range: 20...5000 ms. Default: 0 (deactivated)
			<b>Limits</b>			Activation/deactivation and time setting for the cyclic read of adjustment limits of I, P and R (sink mode) from the adjusted „ <b>Base ID Cyclic Read + 6</b> “. Range: 20...5000 ms. Default: 0 (deactivated)
		<b>Data Length</b>				Determines the DLC (data length) of all messages sent from the device. <b>AUTO</b> = length can vary between 3 and 8 bytes <b>Always 8 Bytes</b> = length is always 8, filled up with zeros

IF	Level 1	Description
RS232	-	The baud rate is selectable, other serial settings can't be changed and are defined like this: 8 data bits, 1 stop bit, parity = none Baud rates: 2400, 4800, 9600, 19200, 38400, 57600, 115200

Element	Description
<b>Com Timeout</b>	<p><b>Timeout USB/RS232</b> (in milliseconds) Default value: 5, Range: 5...65535 Defines the max. time between two subsequent bytes or blocks of a transferred message. For more information about the timeout refer to the external programming documentation "Programming ModBus &amp; SCPI".</p> <p><b>Timeout ETH</b> (in seconds) Default value: 5, Range: 5...65535 Defines a timeout after which the device would close the socket connection if there was no command communication between the controlling unit (PC, PLC etc.) and the device for the adjusted time. The timeout is ineffective as long as option "TCP keep-alive" is enabled and the keep-alive network service is running.</p>
<b>Com Protocols</b>	Enables or disables SCPI or ModBus communication protocols for the device. The change is immediately effective after submitting it with ENTER button. Only one of both can be disabled.
<b>Logging</b>	Default setting: disabled Enables/disables the "log to USB stick" feature. Once enabled, you can define the log interval (multiple steps, 500 ms ... 5 s) and the control method. For more refer to „3.5.8. Recording to USB stick (logging)“.

### 3.5.3.8 Menu "HMI Setup"

These settings refer exclusively to the control panel (HMI).

Element	Description
<b>Language</b>	Selection of the display language between German, English (default), Russian or Chinese
<b>Key Sound</b>	Activates or deactivates sounds when touching a touch area in the display. It can usefully signal that the action has been accepted.
<b>Alarm Sound</b>	Activates or deactivates the additional acoustic signal of an alarm or user defined event which has been set to "Action = ALARM". See also „3.7 Alarms and monitoring“ on page 57.
<b>HMI Lock</b>	See „3.8 Control panel (HMI) lock“ on page 59.
<b>Backlight</b>	The choice here is whether the backlight remains permanently on or if it should be switched off when no input via screen or rotary knob is made for 60 s. As soon as input is made, the backlight returns automatically. Furthermore, the backlight intensity can be adjusted here.
<b>Limits Lock</b>	See „3.9 Limits lock“ on page 60

## 3.5.4 Adjustment limits



Adjustment limits are only effective on the related set values, no matter if using manual adjustment or remote control setting!



Defaults are that all set values (U, I, P, R) are adjustable from 0 to 102%.

The full range may be obstructive in some cases, especially for protection of applications against overvoltage. Therefore upper and lower limits for current (I) and voltage (U) can be set separately, which then limit the range of the adjustable set values.

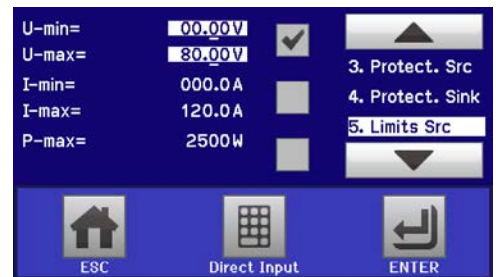
For power (P) and resistance (R) only upper value limits can be set.



### ► How to configure the adjustment limits

1. On the main screen, tap **SETTINGS** to access the SETTINGS menu.
2. Tap the arrows   to select "5. Limits Src" or "6. Limits Sink".
3. In each case a pair of upper and lower limits for U/I or the upper limit for P/R are assigned to the rotary knobs and can be adjusted. Tap the selection areas  to select a different set of parameters.



4. Accept the settings with **ENTER**.



The set values can be entered directly using the ten-key pad. This appears when the touch area "Direct Input" is tapped (bottom centre)



The adjustment limits are coupled to the set values. It means, that the upper limit may not be set lower than the corresponding set value. Example: If you wish to set the limit for the power set value (P-max) to 2000 W while the currently adjusted power set value is 2500 W, then the set value first would have to be reduced to 2000 W or less, in order to set P-max down to 2000 W.

## 3.5.5 Changing the operating mode

In general, the manual operation of a PSB 9000 distinguishes between two or three operating modes, U/I and U/P and U/R, which are tied to set value input using the rotary knobs or ten-key pad. This assignment must be changed if one of the three or four set values is to be adjusted which is currently not assigned to any of the knobs.

### ► How to change the operating mode (two options)

1. Unless the device is in remote control or the panel is locked, you can switch the operation anytime. Tap on the depiction of the right-hand knob (see figure to the right) to change its assignment between I, 2x P and 2x R (if resistance mode is activated), which is then displayed accordingly.
2. Directly tap on the coloured areas with the set values, like shown in the figure to the right. The physical unit next to the set value, when inverted, indicates the assignment to the knob. In the example in the figure it has U and P (sink) assigned, which means U/P mode.

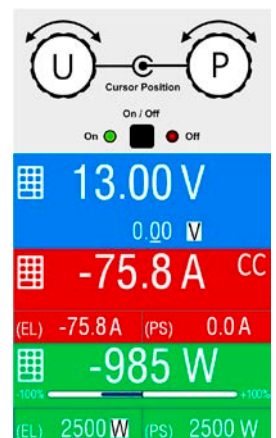

Depending on the selection the right rotary knob will be assigned different setting values, the left knob is always assigned to the voltage.



In order to avoid constant changing of the assignments it's possible, e. g. with selection U/I being active, to change the other value P by direct input, which can be accessed by tapping the small ten-key pad symbol. See section 3.5.6.

The actual operating mode, which is only indicated while the DC terminal is switched on, solely depends only on the set values. For more information see section „3.3. Operating modes“.

## 3.5.6 Manual adjustment of set values

The set values for voltage, current and power are the fundamental operating possibilities of a power supply and hence the two rotary knobs on the front of the device are always assigned to two of the values in manual operation.

For each mode, sink and source, the device has separately adjustable set values for current, power and resistance which are labelled accordingly in the display. The resistance value is connected to the "R mode", which can be activated in the MENU, in the General Settings. Refer to „3.5.3. Configuration via MENU“ as well as „3.3.4. Internal resistance regulation (source mode)“ and „3.3.5. Resistance regulation / constant resistance (sink mode)“ for details.

Set values can be entered manually in two ways, via **rotary knob** or **direct input**. While the rotary knobs adjust values continuously, entering them via numeric pad can be used to change values in bigger steps.



*Entering a value changes it immediately and no matter if the DC power stage is switched on or off.*



*When adjusting set values, upper and lower limits may come into effect. See section „3.5.4. Adjustment limits“. Once a limit is reached, the display will show a small note like "Limit: U-max" etc. for 1.5 seconds next to the adjusted value or will refuse to accept a value entered by direct input.*

### ► How to adjust set values U, I, P or R with the rotary knobs

1. First check if the value you want to change is already assigned to one of the rotary knobs. The main screen displays the assignment as depicted in the figure to the right.
2. If, as shown in the example, the assignment is voltage (U, left) and power (P, right), and it's required to set the current, then the assignments can be changed by tapping the depiction of the right-hand knob until it shows "I". In the left-hand display area one of the set values of current, for sink or source mode, is indicated as selected by its unit being display inverted.
3. After successful selection, the desired value can be set within the defined limits. Selecting a digit is done by pushing the rotary knob which shifts the cursor from right to left (selected digit will be underlined):

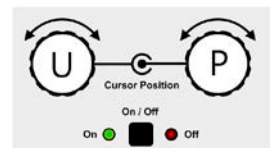

**120.00 A** → **120.00 A** → **120.00 A**

### ► How to adjust values via direct input:

1. In the main screen, depending on the rotary knob assignment, values can be set for voltage (U), current (I), power (P) or resistance (R) via direct input by tapping on one of the small ten-key pad symbols, for example the one in the blue area if you wanted to adjust the voltage.
2. Enter the required value using the ten-key pad. Similar to a pocket calculator the key **c** clears the input.



Decimal values are set by tapping the point key. For example, 54.3 V is set with **5** **4** **.** **3** and **ENTER**.

3. The display then switches back to the main page and the set values take effect.



*Upon entering a value which exceeds the corresponding limit, a note would pop up, the value in the frame reset to 0 and not be accepted and submitted.*



### 3.5.7 Switching the DC terminal on or off

The DC terminal of the device can be manually or remotely switched on and off. This can be restricted in manual operation by the control panel being locked. After switching it on, it either works as input (sink mode) or output (source mode). More information can be found in „3.3.6. Sink-source mode switching“.



*Switching the DC terminal on during manual operation or digital remote control can be disabled by pin REM-SB of the built-in analog interface. For more information refer to 3.5.3.1 and example a) in 3.6.4.7.*

#### ► How to manually switch the DC terminal on or off

1. As long as the control panel isn't fully locked press the button **On/Off**. Otherwise you are asked to disable the HMI lock first.
2. This button toggles between DC terminal on or off, as long as a change isn't restricted by an alarm or the device being locked in "remote".

#### ► How to remotely switch the DC terminal on or off via the analog interface

1. See section „3.6.4 Remote control via the analog interface (AI)“ on page 52.

#### ► How to remotely switch the DC terminal on or off via the digital interface

1. See the external documentation "Programming Guide ModBus & SCPI" if you are using custom software, or refer to the external documentation from LabView VIs or other software provided by the manufacturer.

### 3.5.8 Recording to USB stick (logging)

Device data can be recorded to USB stick (2.0 / 3.0 may work, but not all vendors are supported) anytime. For specifications of the USB stick and the generated log files refer to section „1.9.6.5. USB port (front side)“.

The logging stores files of CSV format on the stick. The layout of the log data is the same as when logging via PC with software EA Power Control. The advantage of USB logging over PC logging is the mobility and that no PC is required. The logging feature just has to be activated and configured in the MENU.

#### 3.5.8.1 Configuration 1



Also see section 3.5.3.7. After USB logging has been enabled and the parameters "Logging interval" and "Start/Stop" have been set, logging can be started anytime from within the MENU or after leaving it, depends on the selected start/stop mode.

#### 3.5.8.2 Configuration 2

Also see section 3.5.3.1. There are additional settings for the CSV file itself as generated by the USB logging features. You can switch the column separator format between german/european standard ("Default") or US american standard ("US"). The other option is used to deactivate the physical unit that is added by default to every values in the log file. Deactivating this option simplifies the CSV file processing in MS Excel.

#### 3.5.8.3 Handling (start/stop)

With setting "**Start/stop with DC terminal ON/OFF**" logging will start each time the DC terminal of the device is switched on, no matter if manually with the front button "On/Off" or remotely via analog or digital interface. With setting "**Manual start/stop**" it's different. Logging is then started and stopped only in the MENU, in the logging configuration page.

Soon after logging has been started, the symbol  indicates the ongoing logging action. In case there is an error while logging, such as USB stick full or removed, it will be indicated by another symbol (). After every manual stop or switching the DC terminal off the logging is stopped and the log file closed.

## 3.5.8.4 USB logging file format

Type: text file in german/european or US american CSV format (depending on the selected setting)

Layout (default german number format shown):

	A	B	C	D	E	F	G	H	I	J	K	L	M	N	O	P
1	U set	U actual	I set (PS)	I actual	P set (PS)	P actual	R set (PS)	R actual	R mode	I set (EL)	P set (EL)	R set (EL)	Output/Input	Device mode	Error	Time
2	0,0V	50,0V	5,00A	-30,00A	2500W	-1500W	N/A	N/A	OFF	30,00A	2500W	N/A	ON	CC	NONE	00:00:00,354
3	0,0V	50,0V	5,00A	-40,00A	2500W	-2000W	N/A	N/A	OFF	40,00A	2500W	N/A	ON	CC	NONE	00:00:00,854
4	0,0V	50,0V	5,00A	-20,00A	2500W	-1000W	N/A	N/A	OFF	20,00A	2500W	N/A	ON	CC	NONE	00:00:01,354
5	0,0V	50,0V	5,00A	0,00A	2500W	0W	N/A	N/A	OFF	50,00A	2500W	N/A	OFF	NONE	NONE	00:00:01,854

Legend:

**U set:** Voltage set value

**I set (PS) / P set (PS) / R set (PS):** Set values from source mode

**I set (EL) / P set (EL) / R set (EL):** Set values from sink mode

**U actual / I actual / P actual / R actual:** Actual values

**Output/Input:** State of the DC terminal at the time of record

**Error:** device alarms

**Time:** elapsed time since logging start

**Device mode:** actual regulation mode (also see „3.3. Operating modes“)

Important to know:

- R set and R actual are only recorded if “R mode” is “ON” (refer to section 3.5.5)
- Unlike the logging on PC, every log start here creates a new log file with a counter in the file name, starting generally with 1, but minding existing files

## 3.5.8.5 Special notes and limitations

- Max. log file size (due to FAT32 formatting): 4 GB
- Max. number of log files in folder HMI\_FILES: 1024
- With setting “**Start/stop with DC terminal ON/OFF**”, the logging will also stop on alarms or events with action “Alarm”, because they switch off the DC terminal
- With setting “**Manual start/stop**” the device will continue to log even on occurring alarms, so this mode can be used to determine the period of temporary alarms like OT or PF

## 3.6 Remote control

### 3.6.1 General

Remote control is possible via the built-in analog or USB port or via one of the optional interface modules (only with standard models) or via the GPIB port (only with option 3W installed). Important here is that only the analog or one digital interface can be in control. One of the digital ones is the master-slave bus.

It means that if, for example, an attempt were to be made to switch to remote control via the digital interface whilst analog remote control is active (pin REMOTE = LOW) the device would report an error via the digital interface. In the opposite direction, a switch-over via Pin Remote would be ignored. In both cases, however, status monitoring and reading of values are always possible.

### 3.6.2 Control locations

Control locations are those locations from where the device can be controlled. Essentially there are two: at the device (manual operation) and external (remote control). The following locations are defined:

Displayed location	Description
-	If neither of the other locations is displayed then manual control is active and access from the analog and digital interfaces is allowed. This location isn't explicitly displayed
<b>Remote</b>	Remote control via any interface is active
<b>Local</b>	Remote control is locked, only manual operation is allowed.

Remote control may be allowed or inhibited using the setting "**Allow remote control**" (see „3.5.3.1. Menu "General Settings"). In inhibited condition the status "**Local**" will be displayed top right. Activating the inhibit can be useful if the device is remotely controlled by software or some electronic device, but it's required to make adjustments at the device or deal with emergency, which would not be possible remotely.

Activating condition "**Local**" causes the following:

- If remote control via the digital interface is active ("**Remote**"), then it's immediately terminated and in order to continue remote control once "**Local**" is no longer active, it has to be reactivated at the PC
- If remote control via the analog interface is active ("**Remote**"), then it's temporarily interrupted until remote control is allowed again by deactivating "**Local**", because pin REMOTE continues to signal "remote control = on", unless this has been changed during the "**Local**" period.

### 3.6.3 Remote control via a digital interface

#### 3.6.3.1 Selecting an interface

The standard models of series PSB 9000 support, in addition to the built-in USB port, the following optionally available interface modules:

Short ID	Type	Ports	Description*
IF-AB-CANO	CANopen	1	CANopen slave with generic EDS
IF-AB-RS232	RS232	1	Standard RS232, serial
IF-AB-PBUS	Profibus	1	Profibus DP-V1 slave
IF-AB-ETH1P	Ethernet	1	Ethernet TCP
IF-AB-PNET1P	ProfiNet	1	Profinet DP-V1 slave
IF-AB-MBUS	ModBus TCP	1	ModBus TCP via Ethernet
IF-AB-ETH2P	Ethernet	2	Ethernet TCP, with switch
IF-AB-MBUS2P	ModBus TCP	2	ModBus TCP via Ethernet
IF-AB-PNET2P	ProfiNet	2	Profinet DP-V1 slave, with switch
IF-AB-CAN	CAN	1	CAN 2.0 A / 2.0 B
IF-AB-ECT	EtherCAT	2	Basic EtherCAT slave with CoE

\* For technical details of the various modules see the extra documentation "Programming Guide Modbus & SCPI"

Models with option 3W installed offer an additional pre-installed GPIB port next to the default USB port.

### 3.6.3.2 General information about the interface modules

With the standard models of series PSB 9000, one of the plug-in and retrofittable modules listed in 3.6.3.1 can be installed. It can take over remote control of the device alternatively to the built-in USB type B on the back side or analog interface. For installation see section „2.3.9. Installation of an interface module“ and separate documentation.

The modules require little or no settings for operation and can be directly used with their default configuration. All specific settings will be permanently stored such that, after changeover between the various models, no reconfiguration will be necessary.

### 3.6.3.3 Programming

Programming details for the interfaces, the communication protocols etc. are to be found in the documentation “Programming Guide ModBus & SCPI“ which is supplied on the included USB stick or which is available as download from the manufacturer’s website.

## 3.6.4 Remote control via the analog interface (AI)

### 3.6.4.1 General

The built-in, galvanically isolated, 15-pole analog interface (short: AI) is on the back side of the device offers the following possibilities:

- Remote control of current, voltage, power and resistance
- Remote status monitoring (CV, DC terminal)
- Remote alarm monitoring (OT, OVP, PF, OCP, OPP)
- Remote monitoring of actual values
- Remote on/off switching of the DC terminal

Setting the **three** set values of voltage, current and power via the analog interface must always be done concurrently. It means, that for example the voltage can’t be given via the AI and current and power set by the rotary knobs, or vice versa. The internal resistance set value can additionally be adjusted. Contrary to manual adjustment or via digital interface, the analog interface doesn’t offer separate set values of power and current for the source and sink mode.

Analog set values can be supplied by an external voltage or generated from the reference voltage on pin 3. As soon as remote control via the analog interface is activated, the displayed set values will be those provided by the interface. The AI can be operated in the common voltage ranges 0...5 V and 0...10 V, both representing 0...100% of the nominal value. The selection of the voltage range can be done in the device setup. See section „3.5.3. Configuration via MENU“ for details. The reference voltage sent out from pin 3 (VREF) will be adapted accordingly:

**0-5 V:** Reference voltage = 5 V, 0...5 V set value signal (VSEL, CSEL, PSEL, RSEL) correspond to 0...100% rated value (exception:  $R_{Min}...R_{Max}$  for resistance) and 0...100% of the actual values correspond to 0...5 V at the actual value outputs CMON and VMON.

**0-10 V:** Reference voltage = 10 V, 0...10 V set value signal (VSEL, CSEL, PSEL, RSEL) correspond to 0...100% rated value (exception:  $R_{Min}...R_{Max}$  for resistance) and 0...100% of the actual values correspond to 0...10 V at the actual value outputs CMON and VMON.

Input of excess signals (e. g. >5 V in selected 5 V range or >10 V in the 10 V range) are clipped by the device by setting the corresponding set value to 100%.

The OVP set value and other supervision (events) and alarm thresholds can’t be set via the AI and therefore must be adapted to the given situation before the AI is going to be in control.

### Before you begin, please read these important notes about the use of the interface:



*After powering the device and during the start phase the AI signals undefined statuses on the output pins. Those must be ignored until is ready to work.*

- Analog remote control of the device must be activated by switching pin REMOTE (5) first. Only exception is pin REM-SB, which can be used independently
- Before the hardware is connected that will control the analog interface, it shall be checked that it can’t provide voltage to the pins higher than specified
- Set value inputs, such as VSEL, CSEL, PSEL and RSEL (if R mode is activated), must not be left unconnected (i.e. floating) during analog remote control. In case any of the set values isn’t used for adjustment, it can be tied to a defined level or connected to pin VREF (solder bridge or different), so it gives 100%
- Switching between sink and source mode can only be done with the voltage level on pin VSEL. Also see example d) in 3.6.4.7.

## 3.6.4.2 Resolution

The analog interface is internally sampled and processed by a digital microcontroller. This causes a limited resolution of analog steps. The resolution is the same for set values (VSEL etc.) and actual values (VMON/CMON) and is 26214 when working with the 10 V range. In the 5 V range this resolution halves. Due to tolerances, the truly achievable resolution can be slightly lower.

## 3.6.4.3 Acknowledging device alarms

In case of a device alarm occurring during remote control via analog interface, the DC terminal will be switched off the same way as in manual control. The device would indicate an alarm (see 3.7.2) in the front display and, if activated, acoustically and also signal most of them on the analog interface. Which alarms actually are signaled can be set up in the device configuration menu (see „3.5.3.1. Menu “General Settings““).

Some device alarms (OVP, OCP and OPP) have to be acknowledged. Also see „3.7.2. Device alarm and event handling“. Acknowledgment is done with pin REM-SB switching the DC terminal off and on again, means a HIGH-LOW-HIGH edge (min. 50ms for LOW), when using the default level setting for this pin.

There is an **exception**: the SOVP (Safety OVP) alarm, which is only featured with the 60 V model of this series. It can't be acknowledged and requires to power-cycle the device. It can be monitored via the analog interface and would be indicated by the alarms PF and OVP being signaled at the same time, so it would require to select the alarm indication on pin 6 to at least signal PF and for pin 14 to signal OVP in any of the combinations.

## 3.6.4.4 Analog interface specification

Pin	Name	Type*	Description	Default levels	Electrical specifications
1	VSEL	AI	Voltage set value	0...10 V or. 0...5 V correspond to 0..100% of $U_{Nom}$	Accuracy 0-5 V range: < 0.4% ***** Accuracy 0-10 V range: < 0.2% *****
2	CSEL	AI	Current set value (source & sink)	0...10 V or. 0...5 V correspond to 0..100% of $I_{Nom}$	Input impedance $R_i > 40 \text{ k} \dots 100 \text{ k}$
3	VREF	AO	Reference voltage	10 V or 5 V	Tolerance < 0.2% at $I_{max} = +5 \text{ mA}$ Short-circuit-proof against AGND
4	DGND	POT	Digital ground		For all digital control and status signals
5	REMOTE	DI	Switching internal / remote control	Remote = LOW, $U_{Low} < 1 \text{ V}$ Internal = HIGH, $U_{High} > 4 \text{ V}$ Internal = Open	Voltage range = 0...30 V $I_{Max} = -1 \text{ mA}$ at 5 V $U_{LOW \text{ to } HIGH \text{ typ.}} = 3 \text{ V}$ Rec'd sender: Open collector against DGND
6	ALARMS 1	DO	Overheating / power fail alarm	Alarm OT= HIGH, $U_{High} > 4 \text{ V}$ No Alarm OT= LOW, $U_{Low} < 1 \text{ V}$	Quasi open collector with pull-up against $V_{cc}^{**}$ With 5 V on the pin max. flow +1 mA $I_{Max} = -10 \text{ mA}$ at $U_{CE} = 0,3 \text{ V}$ $U_{Max} = 30 \text{ V}$ Short-circuit-proof against DGND
7	RSEL	AI	Resistance value (source & sink)	0...10 V or. 0...5 V correspond to $R_{Min} \dots R_{Max}$	Accuracy 0-5 V range: < 0.4% ***** Accuracy 0-10 V range: < 0.2% *****
8	PSEL	AI	Power set value (source & sink)	0...10 V or. 0...5 V correspond to 0..100% of $P_{Nom}$	Input impedance $R_i > 40 \text{ k} \dots 100 \text{ k}$
9	VMON	AO	Actual voltage	0...10 V or. 0...5 V correspond to 0..100% of $U_{Nom}$	Accuracy 0-5 V range: < 0.4% ***** Accuracy 0-10 V range: < 0.2% *****
10	CMON	AO	Actual current	0...10 V or. 0...5 V correspond to 0..100% of $I_{Nom}$	$I_{Max} = +2 \text{ mA}$ Short-circuit-proof against AGND
11	AGND	POT	Analog ground		For -SEL, -MON, VREF Signals
12	R-ACTIVE	DI	R mode on / off	Off = LOW, $U_{Low} < 1 \text{ V}$ On = HIGH, $U_{High} > 4 \text{ V}$ On = Open	Voltage range = 0...30 V $I_{Max} = -1 \text{ mA}$ at 5 V $U_{LOW \text{ to } HIGH \text{ typ.}} = 3 \text{ V}$ Rec'd sender: Open collector against DGND
13	REM-SB	DI	DC terminal OFF (DC terminal ON) (ACK alarms *****)	Off = LOW, $U_{Low} < 1 \text{ V}$ On= HIGH, $U_{High} > 4 \text{ V}$ On = Open	Voltage range = 0...30 V $I_{Max} = +1 \text{ mA}$ at 5 V Rec'd sender: Open collector against DGND
14	ALARMS 2	DO	Overvoltage alarm Overcurrent alarm Overpower alarm	Alarm = HIGH, $U_{High} > 4 \text{ V}$ No alarm = LOW, $U_{Low} < 1 \text{ V}$	Quasi open collector with pull-up against $V_{cc}^{**}$ With 5 V on the pin max. flow +1 mA $I_{Max} = -10 \text{ mA}$ at $U_{CE} = 0,3 \text{ V}$ , $U_{Max} = 30 \text{ V}$ Short-circuit-proof against DGND
15	STATUS***	DO	Constant voltage regulation active DC terminal	CV = LOW, $U_{Low} < 1 \text{ V}$ CC/CP/CR = HIGH, $U_{High} > 4 \text{ V}$ On = LOW, $U_{Low} < 1 \text{ V}$ Off = HIGH, $U_{High} > 4 \text{ V}$	

\* AI = Analog Input, AO = Analog Output, DI = Digital Input, DO = Digital Output, POT = Potential  
 \*\* Internal Vcc approx. 10 V  
 \*\*\* Only one of both signals possible, see section 3.5.3.1  
 \*\*\*\* Only during remote control  
 \*\*\*\*\* The error of a set value input adds to the general error of the related value on the DC terminal of the device

### 3.6.4.5 Overview of the Sub-D socket

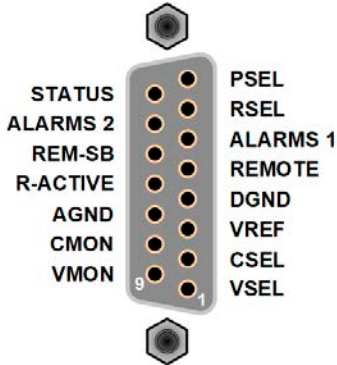

### 3.6.4.6 Simplified diagram of the pins

	<p><b>Digital Input (DI)</b></p> <p>It requires to use a switch with low resistance (relay, switch, circuit breaker etc.) in order to send a clean signal to the DGND.</p>		<p><b>Analog Input (AI)</b></p> <p>High resistance input (impedance &gt;40 k....100 kΩ) for an operational amplifier circuit.</p>
	<p><b>Digital Output (DO)</b></p> <p>A quasi open collector, realized as high resistance pull-up against the internal supply. In condition LOW it can carry no load, merely switch, as shown in the diagram with a relay as example.</p>		<p><b>Analog Output (AO)</b></p> <p>Output from an operational amplifier circuit, low impedance. See specifications table above.</p>

### 3.6.4.7 Application examples

#### a) Switching the DC terminal with pin REM-SB

*A digital output, e. g. from a PLC, may be unable to cleanly pull down the pin as it may not be of low enough resistance. Check the specification of the controlling application. Also see pin diagrams above.*

In remote control, pin REM-SB is used to switch the DC terminal of the device on and off. This function is also available without remote control being active and can on the one hand block the DC terminal from being switched on in manual or digital remote control and on the other hand the pin can switch the DC terminal on or off, but not standalone. See below at “Remote control has not been activated”.

It's recommended that a low resistance contact such as a switch, relay or transistor is used to switch the pin to ground (DGND).

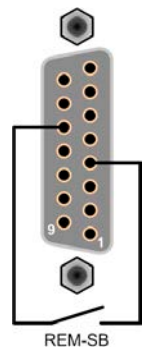

Following situations can occur:

- **Remote control has been activated**

During remote control via analog interface, only pin "REM-SB" determines the states of the DC terminal, according to the levels definitions in 3.6.4.4. The logical function and the default levels can be inverted by a parameter in the setup menu of the device. See 3.5.3.1.



*If the pin is unconnected or the connected contact is open, the pin will be HIGH. With parameter "Analog interface Rem-SB" being set to "Normal", it requests "DC terminal on". So when activating remote control, the DC terminal will instantly switch on.*

- **Remote control has not been activated**

In this mode of operation pin "REM-SB" can serve as lock, preventing the DC terminal from being switched on by any means. This results in following possible situations:

DC terminal	+	Level of pin REM-SB	+	Parameter „Analog interface Rem-SB“	→	Behaviour
is off	+	HIGH	+	Normal	→	The DC terminal isn't locked. It can be switched on by pushbutton "On/Off" (front panel) or via command from digital interface.
		LOW	+	Inverted		
	+	HIGH	+	Inverted	→	The DC terminal is locked. It can't be switched on by pushbutton "On/Off" (front panel) or via command from digital interface. When trying to switch on, a pop-up in the display or an error message will be generated.
		LOW	+	Normal		

In case the DC terminal is already switched on, toggling the pin will switch the DC terminal off, similar to what it does in analog remote control:

DC terminal	+	Level of pin REM-SB	+	Parameter „Analog interface Rem-SB“	→	Behaviour
is on	+	HIGH	+	Normal	→	The DC terminal remains on, nothing is locked. It can be switched on or off by pushbutton or digital command.
		LOW	+	Inverted		
	+	HIGH	+	Inverted	→	The DC terminal will be switched off and locked. Later it can be switched on again by toggling the pin. During lock, pushbutton or digital command can delete the request to switch on by pin.
		LOW	+	Normal		

## b) Remote control of current and power (source mode)

Requires remote control to be activated (Pin REMOTE = LOW)

The set values PSEL and CSEL are generated from, for example, the reference voltage VREF, using potentiometers for each. Hence the power supply can selectively work in current limiting or power limiting mode. According to the specification of max. 5 mA for the VREF output, potentiometers of at least 10 kΩ must be used.

The voltage set value VSEL is directly connected to VREF and will thus be permanently 100%. This also means that the device can only work in source mode.

If the control voltage is fed in from an external source it's necessary to consider the input voltage ranges for set values (0...5 V oder 0...10 V).



*Use of the input voltage range 0...5 V for 0...100% set value halves the effective resolution.*

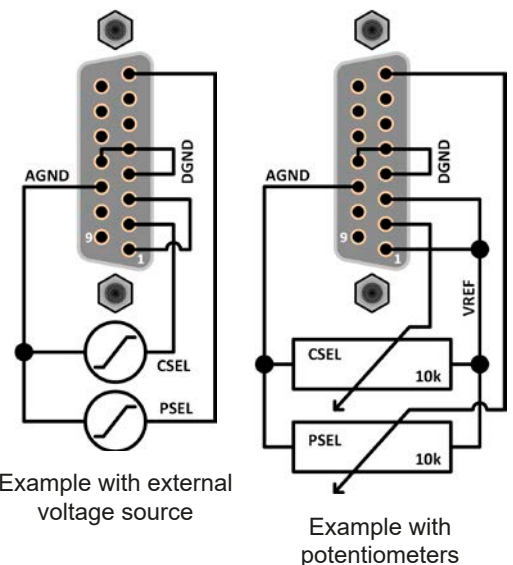

## c) Reading actual values

The AI provides the DC terminal values as current and voltage monitor. These can be read using a standard multimeter or similar.

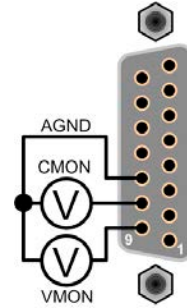

## d) Switching between source and sink mode

You can also switch between both modes when remotely controlling the device with the AI. This is done using the voltage set value (VSEL), which then must not be tied to a fixed potential, like shown in example b). Rules:



- if the voltage set value on VSEL (in %, not the level) becomes higher than the actual voltage on the DC terminal, the device will switch to sink mode, no matter if the voltage on the DC terminal is generated by the device or from external
- if if the voltage set value becomes lower than the actual voltage, the device will switch to source mode



### 3.7 Alarms and monitoring

#### 3.7.1 Definition of terms

There is a clear distinction between device alarms (see „3.4. Alarm conditions“) such as overvoltage protection or overheating protection, and user defined events such as **OVD** (overvoltage detection). Whilst device alarms serve to protect the device or the connected load or external source by initially switching off the DC terminal, user defined events can switch off the DC terminal (Action = ALARM), but can also simply give an acoustic signal to make the user aware. The actions driven by user defined events can be selected:

Action	Impact	Example
<b>NONE</b>	User defined event is disabled.	
<b>SIGNAL</b>	On reaching the condition which triggers the event, the action <b>SIGNAL</b> will show a text message in the status area of the display.	
<b>WARNING</b>	On reaching the condition which triggers the event, the action <b>WARNING</b> will show a text message in the status area of the display and pop up an additional warning message.	
<b>ALARM</b>	On reaching the condition which triggers the event, the action <b>ALARM</b> will show a text message in the status area of the display with an additional alarm pop-up, and additionally emit an acoustic signal (if activated). Furthermore the DC terminal is switched off. Certain device alarms are also signalled to the analog interface or can be queried via the digital interface.	

#### 3.7.2 Device alarm and event handling



Important to know:  
When switching off the DC input (in sink mode) of the device while a current limited source still supplies energy, the output voltage of the source will rise immediately and due to response and settle times in effect, the output voltage can have an overshoot of unknown level which might trigger the overvoltage shutdown OVP or overvoltage supervision event OVD, in case these thresholds are adjusted to too sensitive levels

A device alarm incident will usually lead to DC terminal switch-off, the appearance of a pop-up in the middle of the display and, if activated, an acoustic signal to make the user aware. An alarm must always be acknowledged.

► **How to acknowledge an alarm in the display (during manual control)**

1. If the alarm is indicated as a pop-up, tap **OK**.
2. If the alarm has already been acknowledged, but is still displayed in the status area, then first tap the status area to display the pop-up, and then acknowledge with **OK**.



In order to acknowledge an alarm during analog remote control, see „3.6.4.3. Acknowledging device alarms“. To acknowledge in digital remote, refer to the external documentation “Programming ModBus & SCPI”.

Some device alarms are configurable, separately for source and sink mode:

Short	Long	Description	Range	Indication
<b>OVP</b>	<b>OverVoltage Protection</b>	Triggers an alarm if the voltage on the DC terminal reaches the defined threshold. The DC terminal will be switched off.	0 V...1.1*U <sub>Nom</sub>	Display, analog & digital interface
<b>OCP</b>	<b>OverCurrent Protection</b>	Triggers an alarm if the current in the DC terminal reaches the defined threshold. The DC terminal will be switched off.	0 A...1.1*I <sub>Nom</sub>	Display, analog & digital interface
<b>OPP</b>	<b>OverPower Protection</b>	Triggers an alarm if the output or input power reaches the defined threshold. The DC terminal will be switched off.	0 W...1.1*P <sub>Nom</sub>	Display, analog & digital interface

These device alarms can't be configured and are based on hardware:

Short	Long	Description	Indication
PF	Power Fail	AC supply over- or undervoltage. Triggers an alarm if the AC supply is out of specification or when the device is cut from supply, for example when switching it off with the power switch. The DC terminal will be switched off.	Display, analog & digital interface
OT	OverTemperature	Triggers an alarm if the internal temperature reaches a certain limit. The DC terminal will be switched off.	Display, analog & digital interface
MSP	Master-Slave Protection	Triggers an alarm if the master unit loses contact to any slave unit. The DC terminal will be switched off. The alarm can be cleared by reinitializing the MS system.	Display, digital interface
SOVP	Safety OverVoltage Protection	Only featured in the 60 V model: Triggers a special OVP alarm if the voltage on the DC terminal exceeds the rigid threshold of 101% rated voltage. The DC terminal will be switched off. For details refer to section 3.4.6	Display, analog & digital interface

### ► How to configure the device alarms



1. While the DC terminal is switched off tap the touch area  on the main screen.
2. On the right side tap the arrow to select “**3. Protect Src**” (for source mode) or “**4. Protect Sink**” (for sink mode).
3. Set the limits for the equipment alarm relevant to your application if the default value of 110% is unsuitable.



*The set values can be entered using the ten-key tab. This will appear after tapping the touch area “Direct input”.*

The user also has the possibility of selecting whether an additional acoustic signal will be sounded if an alarm or user defined event occurs.

### ► How to configure the alarm sound (also see “3.5.3. Configuration via MENU”)

1. While the DC terminal is switched off tap the touch area  on the main screen.
2. In the menu page, tap “**HMI Settings**”.
3. In the following menu page, tap “**Alarm Sound**”.
4. In the settings page tap on the symbol to either enable or disable the alarm sound and confirm with .

#### 3.7.2.1 User defined events

The monitoring functions of the device can be configured for user defined events. By default, events are deactivated (action = NONE). Contrary to device alarms, the events only work while the DC terminal is switched on. It means, for instance, that you can't detect undervoltage (UVD) anymore after switching the DC terminal off and the voltage is still sinking.





The following events can be configured independently and separately for sink and source mode and can, in each case, trigger the actions SIGNAL, WARNING or ALARM.

Event	Meaning	Description	Range
UVD	UnderVoltage Detection	Triggers an event if the DC voltage falls below the defined threshold.	0 V...U <sub>Nom</sub>
OVD	OverVoltage Detection	Triggers an event if the DC voltage exceeds the defined threshold.	0 V...U <sub>Nom</sub>
UCD	UnderCurrent Detection	Triggers an event if the DC current falls below the defined threshold.	0 A...I <sub>Nom</sub>
OCD	OverCurrent Detection	Triggers an event if the DC current exceeds the defined threshold.	0 A...I <sub>Nom</sub>
OPD	OverPower Detection	Triggers an event if the DC power exceeds the defined threshold.	0 W...P <sub>Nom</sub>



These events shouldn't be confused with alarms such as OT and OVP which are for device protection. User defined events can, however, if set to action ALARM, switch off the DC terminal and thus protect the load, like a sensitive electronic application.

## ► How to configure user defined events

1. While the DC terminal is switched off tap the touch area  on the main screen.
2. On the right side tap the arrows   to select "7.1 Event U Src" or "7.2 Event I Src" or "7.3 Event P Src" for source mode or 8.1, 8.2 or 8.3 for sink mode.
3. Set the monitoring limits with the left hand rotary knob and the triggered action with the right hand knob relevant to the application (also see „3.7.1. Definition of terms“).
4. Accept the settings with .



User events are an integral part of the actual user profile. Thus, if another user profile or the default profile is selected and used, the events could either be differently configured or not at all.





The set values can be entered using the ten-key tab. This will appear by tapping the touch area "Direct input".

## 3.8 Control panel (HMI) lock

In order to avoid the accidental alteration of a value during manual operation the rotary knobs or the touchscreen can be locked so that no alteration of values will be accepted without prior unlocking.

### ► How to lock the HMI

1. In the main page, tap the lock symbol  (upper right corner). 
2. In the settings page "HMI Lock" you are then asked to chose between a complete HMI ("Lock all") lock or one where the On/Off button is still usable ("ON/OFF possible"), or chose to activate the additional PIN ("Enable PIN"). The device would later request to enter this PIN every time you want to unlock the HMI, until the PIN is deactivated again.
3. Activate the lock with . The locked status is then shown with the small padlock icon.

If an attempt is made to alter something whilst the HMI is locked, a requester appears in the display asking if the lock should be disabled.

### ► How to unlock the HMI

1. Tap any part of the touchscreen of the locked HMI, or turn one of the rotary knobs or press the button "On/Off" (only in "Lock all" situation).



2. This request pop-up will appear:
3. Unlock the HMI by tapping on "Tap to unlock" within 5 seconds, otherwise the pop-up will disappear and the HMI remains locked. In case the additional **PIN code lock** has been activated in the menu "HMI Lock", another requester will pop up, asking you to enter the **PIN** before it finally unlocks the HMI.

## 3.9 Limits lock

In order to avoid the alteration of the adjustment limits (also see „3.5.4. Adjustment limits“) by an unprivileged user, the screen with the adjustment limit settings (“Limits”) can be locked by a PIN code. The menu pages for the limits in SETTINGS and the profiles in MENU will then become inaccessible until the lock is removed by entering the correct PIN or in case it has been forgotten, by resetting the device as last resort.

### ► How to lock the “Limits”

1. While the DC terminal is switched off, tap the touch area  on the main screen.
2. In the menu tap on “HMI Setup” and then “Limits Lock”.
3. In the next page set the check mark next to “Lock”.



*The same PIN as with the HMI lock is used here. It should be set before activating the Limits lock. See „3.8. Control panel (HMI) lock“*

4. Activate the lock by leaving the settings page with .



Be careful to enable the lock if you are unsure what PIN is currently set. In doubt use ESC to exit the menu page. In menu page “HMI Lock” you can define a different PIN, but not without entering the old one.

### ► How to unlock the limits settings

1. While the DC terminal is switched off, tap the touch area  on the main screen.
2. In the menu tap “Limits Lock”.
3. In the next page tap on touch area “Unlock” and then you will be asked to enter the 4-digit PIN.
4. Deactivate the lock by entering the correct PIN and submitting with ENTER.



## 3.10 Loading and saving a user profile

The menu “Profiles” serves to select between a default profile and up to 5 user profiles. A profile is a collection of all settings and set values. Upon delivery, or after a reset, all 6 profiles have the same settings and all set values are 0. If the user changes settings or sets target values then these create a working profile which can be saved to one of the 5 user profiles. These profiles or the default one can then be switched. The default profile is read-only.

The purpose of a profile is to load a set of set values, settings limits and monitoring thresholds quickly without having to readjust these. As all HMI settings are saved in the profile, including language, a profile change can also be accompanied by a change in HMI language.

On calling up the menu page and selecting a profile the most important settings can be seen, but not changed.

### ► How to save the current values and settings as a user profile:

1. While the DC terminal is switched off, tap the touch area  on the main screen. In the menu page, tap .
2. In the selection screen (right) choose between user profile 1-5 in which the settings are to be saved. The profile will then be displayed and the values can be checked, but not changed.

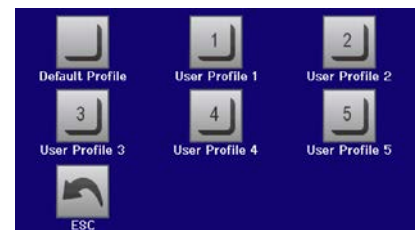

3. Save using the touch area .

### 3.11 The function generator

#### 3.11.1 Introduction

The built-in **function generator** (short: **FG**) is able to create various signal forms and apply these to the set value of either voltage or current.

The standard functions are based on an **arbitrary generator** and directly accessible and configurable using manual control. In remote control, the fully customizable arbitrary generator replicates these functions with sequence points containing 8 parameters each.

Other functions, such as IU, PV or FC are based on an **XY generator** that works with a table of 4096 values which are either loaded from an USB stick or calculated based upon adjustable parameters.

The following functions are retrievable, configurable and controllable:

Function	Short description
Sine wave	Sine wave generation with adjustable amplitude, offset and frequency
Triangle	Triangular wave signal generation with adjustable amplitude, offset, rise and fall times
Rectangular	Rectangular wave signal generation with adjustable amplitude, offset and duty cycle
Trapezoid	Trapezoidal wave signal generation with adjustable amplitude, offset, rise time, pulse time, fall time, idle time
DIN 40839	Simulated automobile engine start curve according to DIN 40839 / EN ISO 7637, split into 5 curve sequences, each with a start voltage, final voltage and time
Arbitrary	Generation of a process with up to 99 freely configurable curve points, each with a start and end value (AC/DC), start and end frequency, phase angle and total duration
Ramp	Generation of a linear rise or fall ramp with start and end values and time before and after the ramp
IU	XY generator, USB stick loadable current curve (table, CSV)
PV, FC	Functions to simulate a solar panel (PV function) or fuel cells (FC function), both with table calculation based upon adjustable parameters, also for EN 50530
Battery test	Battery discharge test with constant or pulsed current, along with Ah, Wh and time counters
MPP Tracking	Simulation of the characteristic tracking behaviour of solar inverters when seeking to find the maximum power point (MPP) when being connected to typical sources such as solar panels

#### 3.11.2 General

##### 3.11.2.1 Limitations

The function generator isn't accessible, neither for manual access, nor for remote control, if resistance mode (U/R adjustment, also called UIR) is active.

##### 3.11.2.2 Principle

The device features a built-in function generator (short: FG), but the entire unit can't be considered as high power function generator, because its power stages are only post-connected to the FG. Primarily in source mode, the typical characteristics of a voltage and current source remain. Rise and fall times, caused by capacitor charge/discharge, affect the resulting signal on the DC terminal. While the FG is able to generate a sine wave with 1000 Hz, the device will never be able to follow the generated signal 1:1. Source and sink mode will slightly differ from each other regarding the results, while the sink mode will be generally better, because primarily focused on current.

Depiction of principle:

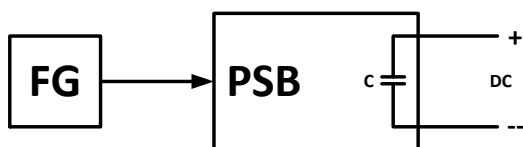

Effect of the DC power stages on functions:

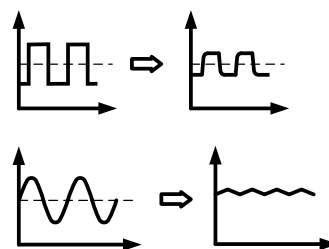

The resulting wave on the DC terminal heavily depends on the frequency or period of the selected wave, its amplitude and also the voltage rating of the device. The effect of the capacities on the wave can be partially compensated. In source mode and when running voltage dynamics to which the capacities have the biggest impact on it can help to put an additional load to the DC terminal in order to decrease rise and fall times. This extra load has a positive impact on periodic functions like rectangle or sine wave.

### 3.11.2.3 Resolution

Amplitudes generated by the arbitrary generator have an effective resolution of approx. 52428 steps. If the amplitude is very low and the time long, the device would generate less steps and set multiple identical values after another, generating a staircase effect. It's furthermore not possible to generate every possible combination of time and a varying amplitude (slope).

### 3.11.2.4 Possible technical complications

Operation of switching mode power supplies as a voltage source can, when applying a function to the output voltage, lead to damage of the output capacitors due to continuous charging/discharging which causes overheating. Furthermore the actual voltage progression may differ from what's expected.

### 3.11.2.5 Minimum slope / maximum ramp time

When using a rising or falling offset (i.e. DC part) at functions like ramp, trapezoid, triangle and even sine wave, a minimum slope, calculated from the rated values of voltage or current, is required or else the adjusted settings would be neglected by the device. Calculating the minimum slope can help to determine if a certain ramp over time can be achieved by the device or not. Example: model PSB 9080-120 is going to be used, with 80 V and 120 A rating. **Formula: minimum slope = 0.000725 \* rated value / s.** For the example model it results in  $\Delta U/\Delta t$  of 58 mV/s and  $\Delta I/\Delta t$  of 87 mA/s. The maximum time which can be achieved with the minimum slope then calculates as approximately 1379 seconds according to formula  $t_{\text{Max}} = \text{rated value} / \text{min. slope}$ .

### 3.11.3 Method of operation

In order to understand how the function generator works and how the value settings interact, the following should be noted:

**The device operates, including in function generator mode, always with the three set values U, I and P.**

The selected function can be applied to U or I set value, while all other set values are then constants and have a limiting effect.

That means if, for example, a voltage of 10 V is set in source mode for the DC output, a load is connected and a sine wave function should operate on the current with an amplitude of 20 A and offset 20 A, then the function generator will create a sine wave progression of current between 0 A (min) and 40 A (max), which will result in an output power between 0 W (min) and 400 W (max). But in case the output power would be limited to, for instance, 300 W, the current would be limited to 30 A and, if clamped to an oscilloscope, it would be seen to be truncated at 30 A and never reach the target of 40 A.

**For an even better understanding how the device works in dynamic operation read following:**



- The device also has an integrated electronic load, here called "sink", which is supposed to discharge the capacities on the DC terminal of the device when running dynamic voltage changes in source mode, i.e. higher voltage to lower voltage. This requires a certain current and thus power, which can and should be adjusted for almost every function described below (parameters "I Sink" and "P Sink"). For safety reasons, the current value "I Sink" is always set to 0 after selecting a function for configuration, thus deactivating sink mode.
- The sink current, as adjustable with parameter "I Sink", when being set to > 0, would also discharge capacities being present in an external load application or load an external voltage source and thus this current setting has to be chosen carefully, because it also affects the necessary cross section of cables. Recommendation: Set I Sink to at least  $I_{\text{Peak}}$  of the resulting curve

Master-slave systems have further characteristics which have to be considered:



At the end of the configuration of every standard function you are requested to set up global set values, the so-called "U/I/P limits". These limits are transferred to all slave units of master-slave systems. It's recommended to carefully configure them so the MS system can work as expected and the slaves wouldn't impact the function run in a negative way.



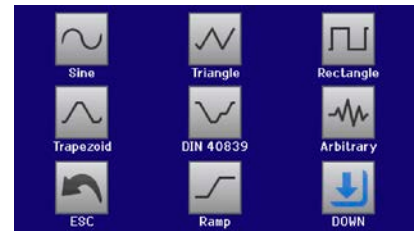

## 3.11.4 Manual operation

### 3.11.4.1 Function selection and control

Via the touch screen one of the functions described in 3.11.1 can be selected, configured and controlled. This is only permissible while the DC terminal is switched off.



#### ► How to select a function and adjust parameters

1. While the DC terminal is switched off tap the touch area  on the main screen.
2. In the menu tap on the touch area  and then on the desired function.  
Note: this touch area is locked in R mode (adjustable resistance).
3. Depending on the choice of function there follows a request to which value the function generator is going to be applied:  or .
4. Adjust the parameters as you desire, like offset, amplitude and frequency for a sine wave, for example.
5. Adjust the overall limits of voltage, current and power, which you can access with touch area .



*When entering function generator mode those limits are reset to safe values, which can prevent the function from working at all. For example, if you apply the selected function to the output current (source mode), then the overall current limit shouldn't interfere and should at least be as high as offset + amplitude.*

Setting the various functions is described below. After setting it up, the function can be loaded.

#### ► How to load a function

1. After setting the values for the required signal generation, tap on the touch area .

The device will then load the data into the internal controller and changes the display. Shortly afterwards the static values are set (power and voltage or current), the DC terminal is switched on and the touch area  enabled.

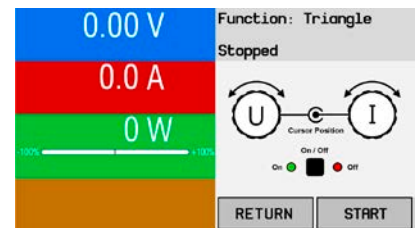



Only then can the function be started.



*The static values are applied to the DC terminal immediately after loading the function and in order to set the start situation. They represent start and end values for the progress of the function, so that it doesn't need to start from 0. Only exception: when applying a function to the current (I), there is no adjustable static current value, so the function would always start from 0 A.*

#### ► How to start and stop a function

1. The function can be started either by tapping  or pushing the "On/Off" button, if the DC terminal is currently switched off. The function then starts immediately. In case START is used while the DC terminal is still switched off, it will be switched on automatically.
2. The function can be **stopped** either by tapping  or operating the "On/Off" button. However, there is a difference:
  - a) The  button stops only the function, the DC terminal remains ON with the static values.
  - b) The "On/Off" button stops the function and switches the DC terminal off.



*Any device alarm (overvoltage, overtemperature etc.), protection (OPP, OCP) or event with action = Alarm stops the function progress automatically, switches off the DC terminal and reports the alarm.*

### 3.11.5 Sine wave function

Restrictions which apply particularly to this function:

- There is no preselection to which of both, source mode and sink mode, the function is applied to; the settings decide whether it's "source mode only", "sink mode only" or a mixture of both
- When applying the function to the voltage, the device can only switch to and work in sink mode if the external voltage on the DC terminal is higher than the highest point (offset + amplitude) of the wave and the current setting "I Sink" isn't 0

The following parameters can be configured for a sine function:

Value	Range	Description
U(A), I(A)	0...(rated value - [Offs]) of U or I	A = Amplitude of the signal to be generated
U(Offs)	0... (U <sub>Nom</sub> - A)	Offs = Offset from the zero point of the mathematical sine curve
I(Offs)	- (I <sub>Nom</sub> - A)...+(I <sub>Nom</sub> - A)	
f (1/t)	1...10000 Hz	Static frequency of the signal to be generated

Schematic diagram:

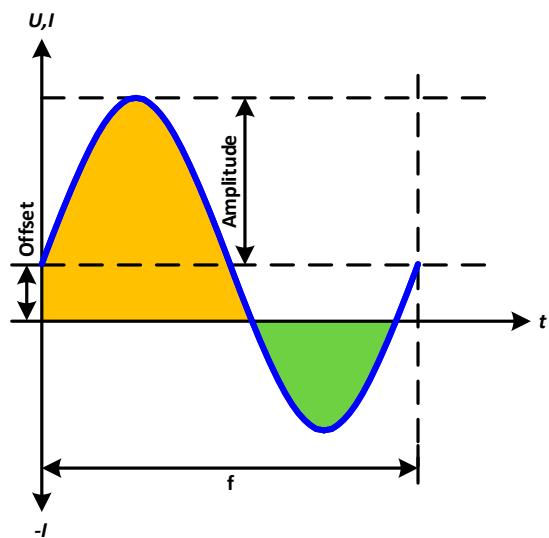

Application and result:

A sine wave signal is generated and applied to the selected set value, e. g. the current (I mode). Depending on the adjusted parameters the device can either apply the wave either solely to sink mode or to source mode, but also to both with automatic switchover at zero point. The scheme on the left depicts the "mixed mode" run (yellow = source mode active, green = sink mode active). While the amplitude is always an absolute value, the offset can be positive or negative (I mode only).

For calculating the maximum power the current amplitude and the offset value have to be added.

Example: a voltage of 30 V is set as static value. The parameters for the sin(I) function are: amplitude of 40 A and offset of +30 A. The resulting maximum power when reaching the highest point of the sine wave then is  $(40\text{ A} + 30\text{ A}) * 30\text{ V} = 2100\text{ W}$  for the part in source mode and when reaching the lowest point (sink mode) it will be  $(40\text{ A} - 30\text{ A}) * 30\text{ V} = -300\text{ W}$ .

### 3.11.6 Triangular function

Restrictions which apply particularly to this function:

- There is no preselection to which of both, source mode and sink mode, the function is applied to; the settings decide whether it's "source mode only", "sink mode only" or a mixture of both
- When applying the function to the voltage, the device can only switch to and work in sink mode if the external voltage on the DC terminal is higher than the highest point (offset + amplitude) of the wave and the current setting "I Sink" isn't 0

The following parameters can be configured for a triangular function:

Value	Range	Description
U(A), I(A)	0...(rated value - [Offs])	A = Amplitude of the signal to be generated
U(Offs)	0... (U <sub>Nom</sub> - A)	Offs = Offset, based on the foot of the triangular wave
I(Offs)	- (I <sub>Nom</sub> - A)...+(I <sub>Nom</sub> - A)	
t1	0.1 ms...36000 s	Rising edge time Δt of the triangular wave signal
t2	0.1 ms...36000 s	Falling edge time Δt of the triangular wave signal



Schematic diagram:

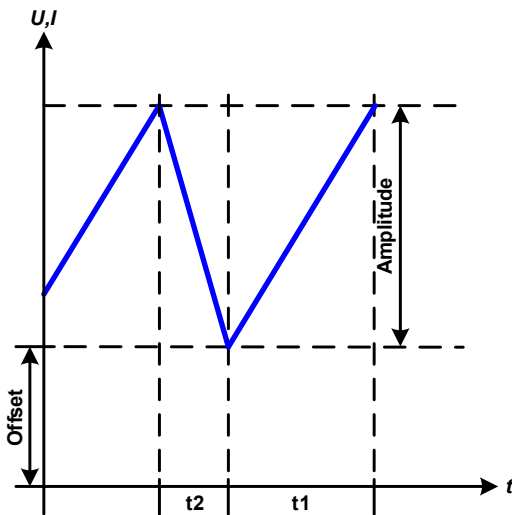

Application and result:

A triangular wave signal for use on the current or voltage is generated. The positive and negative slope times can be set independently.

The offset shifts the signal on the Y axis.

The sum of the intervals  $t_1$  and  $t_2$  gives the cycle time and its reciprocal is the frequency.

Example: a frequency of 10 Hz is required and would lead to periodic duration of 100 ms. This 100 ms can be freely allocated to  $t_1$  and  $t_2$ , e. g. 50 ms:50 ms (isosceles triangle) or 99.9 ms:0.1 ms (right-angled triangle or sawtooth).

### 3.11.7 Rectangular function

Restrictions which apply particularly to this function:

- There is no preselection to which of both, source mode and sink mode, the function is applied to; the settings decide whether it's "source mode only", "sink mode only" or a mixture of both
- When applying the function to the voltage, the device can only switch to and work in sink mode if the external voltage on the DC terminal is higher than the highest point (offset + amplitude) of the wave and the current setting "I Sink" isn't 0

The following parameters can be configured for a rectangular function:

Value	Range	Description
U(A), I(A)	0...(rated value - [Offs])	A = Amplitude of the signal to be generated
U(Offs)	0... ( $U_{Nom} - A$ )	Offs = Offset, based on the foot of the rectangular wave
I(Offs)	- ( $I_{Nom} - A$ )...+ ( $I_{Nom} - A$ )	
$t_1$	0.1 ms...36000 s	Time (pulse width) of the upper level (amplitude)
$t_2$	0.1 ms...36000 s	Time (pause width) of the lower level (offset)

Schematic diagram:

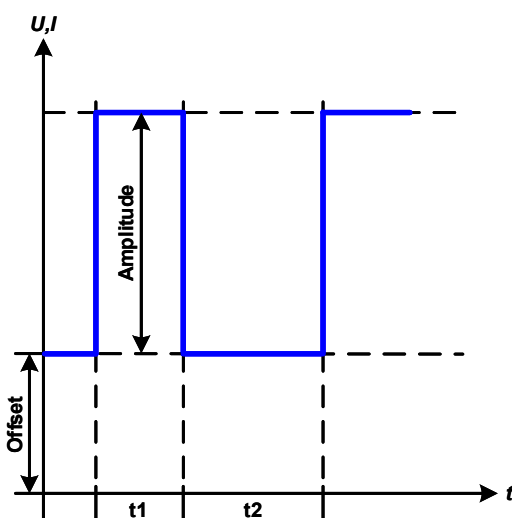

Application and result:

A rectangular or square wave signal for use on the current or voltage is generated. The intervals  $t_1$  and  $t_2$  define how long the value of the amplitude (pulse) and how long the value of the offset (pause) are effective.

The offset shifts the signal on the Y axis.

Intervals  $t_1$  and  $t_2$  can be used to define a duty cycle. The sum of  $t_1$  and  $t_2$  gives the period and its reciprocal the frequency.

Example: a rectangular wave signal of 25 Hz and a duty cycle of 80% are required. The sum of  $t_1$  and  $t_2$ , the period, is  $1/25 \text{ Hz} = 40 \text{ ms}$ . For a duty cycle of 80% the pulse time ( $t_1$ ) is  $40 \text{ ms} \cdot 0.8 = 32 \text{ ms}$  and the pause time ( $t_2$ ) is 8 ms

**3.11.8 Trapezoidal function**

Restrictions which apply particularly to this function:

- There is no preselection to which of both, source mode and sink mode, the function is applied to; the settings decide whether it's "source mode only", "sink mode only" or a mixture of both
- When applying the function to the voltage, the device can only switch to and work in sink mode if the external voltage on the DC terminal is higher than the highest point (offset + amplitude) of the wave and the current setting "I Sink" isn't 0

The following parameters can be configured for a trapezoidal function:

Value	Range	Description
U(A), I(A)	0...(rated value - [Offs])	A = Amplitude of the signal to be generated
U(Offs)	0... (U <sub>Nom</sub> - A)	Offs = Offset, based on the foot of the trapezium
I(Offs)	-(I <sub>Nom</sub> - A)...+(I <sub>Nom</sub> - A)	
t1	0.1 ms...36000 s	Time for the positive slope of the trapezoidal wave signal.
t2	0.1 ms...36000 s	Time for the top value of the trapezoidal wave signal.
t3	0.1 ms...36000 s	Time for the negative slope of the trapezoidal wave signal.
t4	0.1 ms...36000 s	Time for the base value (=offset) of the trapezoidal wave signal

Schematic diagram:

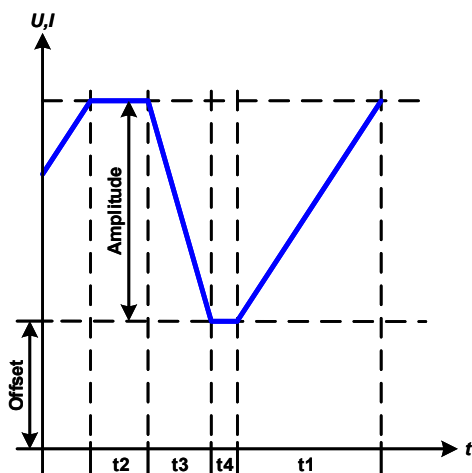

Application and result:

Same as with other functions the generated signal can be applied to the set value of voltage (U mode) or to the current (I mode). The slopes of the trapezium can be varied by adjusting the times for rise and fall separately.

The periodic duration and repetition frequency are the result of the four adjustable time values. With suitable settings the trapezium can be deformed to a triangular or rectangular wave. It has, therefore, universal use.

**3.11.9 DIN 40839 function**

This function is based on the curve defined in DIN 40839 / EN ISO 7637 (test impulse 4), and is only applicable to voltage. It shall replicate the progress of automobile battery voltage during engine starting. The curve is divided into 5 parts (see diagram below) which each have the same parameters. The standard values from the DIN are set already as default values for the five sequence points.

Typically, this function is used with power supplies (here: source mode), but can also be used with electronic loads (here: sink mode). However, the device can only switch to and work in sink mode if the external voltage on the DC terminal is higher than the highest point (offset + amplitude) of the wave and the external source can't deliver more current than adjusted for sink mode (I sink). Else the device could regulate the voltage values resulting from the curve. The global set values can furthermore clearly define in what operation mode the function is run.

The following parameters can be configured for the single sequence points or the entire function:

Value	Range	Seq	Description
Ustart	0...U <sub>Nom</sub>	1-5	Start voltage of the ramp
Uend	0...U <sub>Nom</sub>	1-5	End voltage of the ramp
Seq.time	0.1 ms...36000 s	1-5	Time of the ramp
Seq.cycles	∞ or 1...999	-	Number of repetitions of the entire curve
Time t1	0.1 ms...36000 s	-	Time after cycle before repetition (cycle <> 1)
U(Start/End)	0...U <sub>Nom</sub>	-	Voltage setting before and after the function run
I/P Source	0...I <sub>Nom</sub> / P <sub>Nom</sub>	-	Global set values for current and power. If either I=0 or P=0, the device would only work in sink mode
I/P Sink	0...I <sub>Nom</sub> / P <sub>Nom</sub>	-	Global set values for current and power. If either I=0 or P=0, the device would only work in source mode

Schematic diagram:

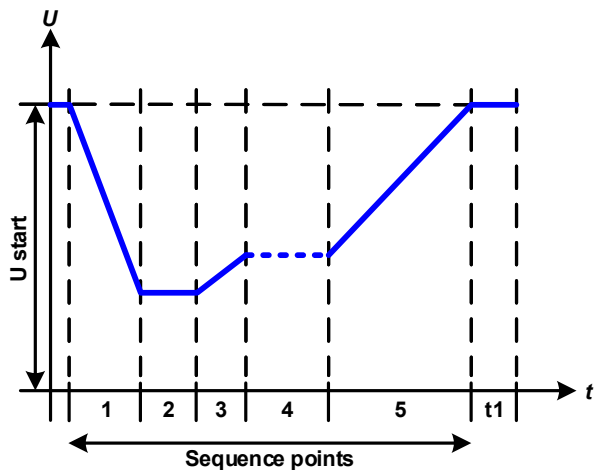

Application and result:

If the function is set up to run in source mode, the built-in load function acts as a sink and ensures the quick output voltage drop as required for some parts of the curve, allowing the output voltage progress to follow the DIN curve.

The curve conforms to test impulse 4 of the DIN. With suitable settings, other test impulses can be simulated. If the curve part in sequence point 4 should contain a sine wave instead, then these 5 sequences would have to be set up for the arbitrary generator.

The global start (and end) voltage is adjustable as parameter "U(Start/end)" in the menu page "U/I/P Limits". It does not modify the voltage settings in the single sequence points, but it should match the start voltage setting (U start) of sequence point 1.

### 3.11.10 Arbitrary function

The arbitrary (freely definable) function offers the user further scope. There are 99 sequence points available for use on either current (I) or voltage (U), all of which have the same set of parameters but can be differently configured, so that a complex function process can be built up. An arbitrary number out of the 99 sequence points can run in a sequence point block, and this block can then be repeated up to 999 times or endlessly. The function only acts on either current or voltage, thus a mix of assignment to current (I) or voltage (U) isn't possible.

The arbitrary curve can overlay a linear progression (DC) with a sine curve (AC) whose amplitude and frequency is shaped between start and end. When both, start frequency and end frequency, are 0 Hz the AC overlay has no impact and only the DC part is effective. Each sequence point is allocated a sequence point time in which the AC/DC curve from start to end will be generated.

The following parameters can be configured for each sequence point in the arbitrary function:

Value	Range	Description
Is(AC)	-50%...+50% $I_{Nom}$	Start amplitude of the sine wave part (I mode)
Ie(AC)	-50%...+50% $I_{Nom}$	End amplitude of the sine wave part (I mode)
Us(AC)	0...50% $U_{Nom}$	Start amplitude of the sine wave part (U mode)
Ue(AC)	0...50% $U_{Nom}$	End amplitude of the sine wave part (U mode)
fs(1/T)	0 Hz...10000 Hz	Start frequency of the sine wave part
fe(1/T)	0 Hz...10000 Hz	End frequency of the sine wave part
Angle	0°...359°	Start angle of the sine wave part
Is(DC)	$\pm(I_s(AC)...(I_{Nom} - I_s(AC)))$	Start value (=offset) of the DC part of the curve (I mode)
Ie(DC)	$\pm(I_e(AC)...(I_{Nom} - I_e(AC)))$	End value (=offset) of the DC part of the curve (I mode)
Us(DC)	$U_s(AC)...(U_{Nom} - U_s(AC))$	Start value (=offset) of the DC part of the curve (U mode)
Ue(DC)	$U_e(AC)...(U_{Nom} - U_e(AC))$	End value (=offset) of the DC part of the curve (U mode)
Seq.time	0.1 ms...36000 s	Time setting of the selected sequence point



The sequence point time (seq. time) and the start and end frequency are related. The minimum value for  $\Delta f/s$  is 9.3. Thus, for example, a setting of  $f_s = 1$  Hz,  $f_e = 11$  Hz and Seq.time = 5 s would not be accepted as  $\Delta f/s$  is only 2. A seq. time of 1 s would be accepted, or, if the time remains at 5 s, then  $f_e = 51$  Hz must be set.



The amplitude change between start and end is related to the sequence time. A minimal change over an extended time isn't possible and in such a case the device will report an inapplicable setting.

After the settings for the selected sequence point are accepted with SAVE, further points can be configured. In a second settings screen, which can be reached by tapping NEXT in the sequence point selection screen, following global settings for all 99 points are adjustable:

Value	Range	Description
Start seq.	1...End seq.	First sequence point in the block
End seq.	Start seq...99	Last sequence point in the block
Seq. Cycles	$\infty$ or 1...999	Number of cycles to run the block

Schematic diagram:

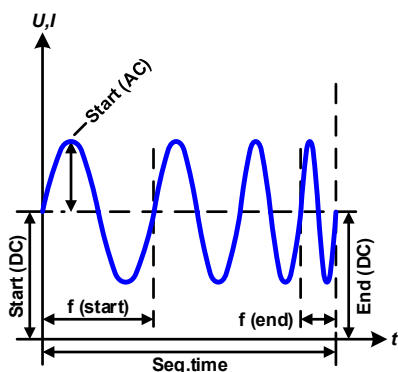
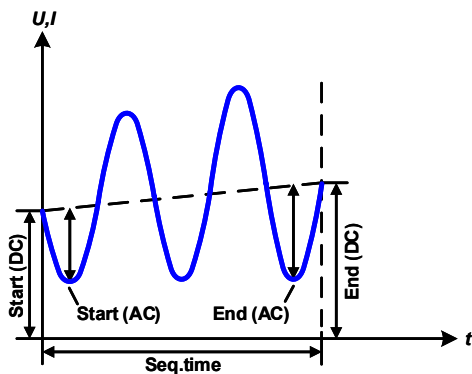
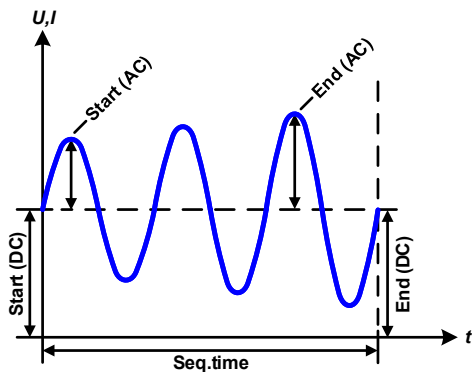
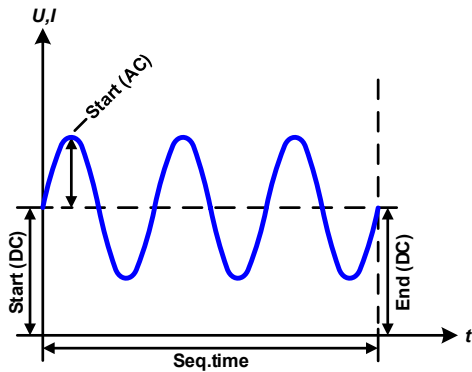

Applications and results:

### Example 1

Focussing 1 cycle of 1 sequence point:

DC values for start and end are the same, also the AC amplitude. With a frequency  $>0$  a sine wave progression of the set value is generated with a defined amplitude, frequency and Y axis offset (DC value at start and end).

The number of sine waves per cycle depend on the sequence point time and the frequency. If the time was 1 s and the frequency 1 Hz, there would be exactly 1 sine wave. If the time was 0.5 s at the same frequency, there would only be a half sine wave.

### Example 2

Focussing 1 cycle of 1 sequence point:

The DC values at start and end are the same but the AC (amplitude) not. The end value is higher than the start so that the amplitude increases with each new half sine wave continuously through the sequence. This, of course, only if the sequence time and frequency allow for multiple waves to be created. e. g. for  $f=1$  Hz and Seq. time = 3 s, three complete waves would be generated (for angle =  $0^\circ$ ) and reciprocally the same for  $f=3$  s and Seq. time=1 s.

### Example 3

Focussing 1 cycle of 1 sequence point:

The DC values at start and end are unequal, as are also the AC values. In both cases the end value is higher than the start so that the offset increases from start to end (DC) and the amplitude also with each new half sine wave.

Additionally the first sine wave starts with a negative half wave because the angle is set at  $180^\circ$ . The start angle can be shifted at will in  $1^\circ$  steps between  $0^\circ$  and  $359^\circ$ .

### Example 4

Focussing 1 cycle of 1 sequence point:

Similar to example 1 but with another end frequency. Here this is shown as higher than the start frequency. This impacts the period of the sine waves such that each new wave will be shorter over the total span of the sequence time.

Schematic diagram:

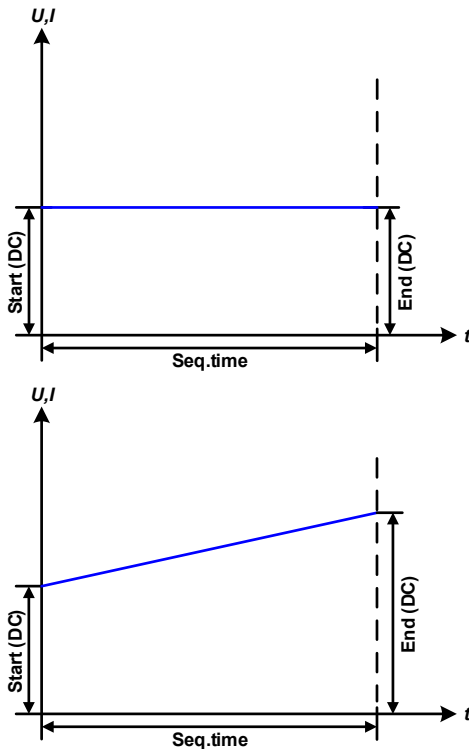

Applications and results:

### Example 5

Focussing 1 cycle of 1 sequence point:

Similar to example 1 but with a start and end frequency of 0 Hz. Without a frequency no sine wave part (AC) will be created and only the DC settings will be effective. A ramp with a horizontal progression is generated.

### Example 6

Focussing 1 cycle of 1 sequence point:

Similar to example 1 but with a start and end frequency of 0 Hz. Without a frequency no sine wave part (AC) will be created and only the DC settings will be effective. Here start and end values are unequal and a steadily increasing ramp is generated.

By linking together a number of differently configured sequence points, complex progressions can be created. Smart configuration of the arbitrary generator can be used to match triangular, sine, rectangular or trapezoidal wave functions and thus, e. g. a sequence of rectangular waves with differing amplitudes or duty cycles could be produced.

Schematic diagram:

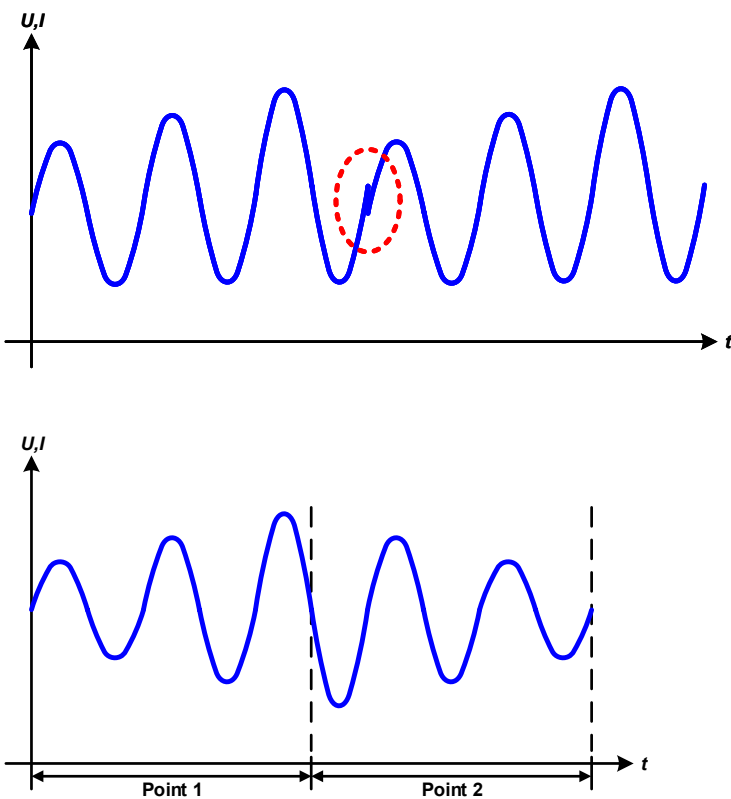

Applications and results:

### Example 7

Focussing 2 cycles of 1 sequence point:

One sequence point, configured as in example 3, is run. Since the settings define that the end offset (DC) is higher than the start, the second run will revert to the same start level as the first, regardless of the signal level at the end of the first run. This can produce a discontinuity in the total progression (marked in red) which may only be compensated with careful choice of settings.

### Example 8

Focussing 1 cycle of 2 sequence points:

Two sequence points run consecutively. The first one generates a sine wave with increasing amplitude, the second one with a decreasing amplitude. Together they produce a progression as shown left. In order to ensure that the maximum wave in the middle occurs only once, the first sequence point must end with a positive half wave and the second one start with a negative half wave as shown in the diagram..

Schematic diagram:

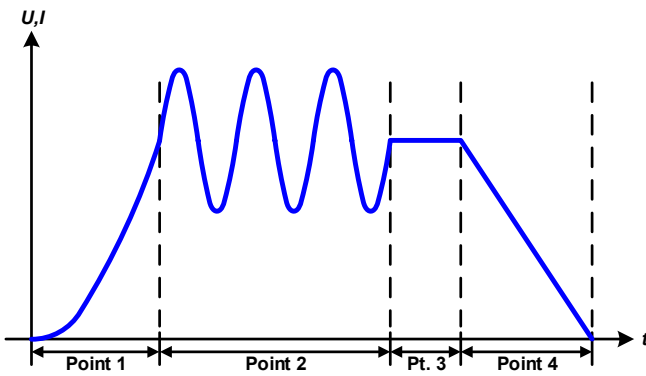

Applications and results:

## Example 9

Focussing 1 cycle of 4 sequence points:

Point 1: 1/4th sine wave (angle = 270°)

Point 2: Three sine waves (ratio of frequency to sequence time: 1:3)

Point 3: Horizontal ramp (f = 0)

Point 4: Falling ramp (f = 0)

### 3.11.10.1 Loading and saving the arbitrary function

The 99 sequence points of the arbitrary function, which can be manually configured with the control panel of the device and which are applicable either to voltage (U) or current (I), can be saved to or loaded from a common USB stick via the front side USB port. Generally, all 99 points are saved or loaded at once using a text file of type CSV which represents a table of values.

In order to load a sequence table for the arbitrary generator, following requirements have to be met:

- The table must contain exactly 99 rows (100 are also accepted for compatibility to previous firmwares), with 8 subsequent values (8 columns) and must not have gaps
- The column separator (semicolon, comma) must be as selected by MENU parameter "USB file separator format"; it also defines the decimal separator (dot, comma)
- The files must be stored inside a folder called HMI\_FILES which has to be in the root of the USB drive
- The file name must always start with WAVE\_U or WAVE\_I (not case-sensitive)
- All values in every row and column have to be within the specified range (see below)
- The columns in the table have to be in a defined order which must not be changed

Following value ranges are given for use in the table, related to the manual configuration of the arbitrary generator (column headers like in Excel):

Column	Parameter	Range
A	AC start amplitude	See table in „3.11.10. Arbitrary function“
B	AC end amplitude	See table in „3.11.10. Arbitrary function“
C	Start frequency	0...10000 Hz
D	End frequency	0...10000 Hz
E	AC start angle	0...359°
F	DC start offset	See table in „3.11.10. Arbitrary function“
G	DC end offset	See table in „3.11.10. Arbitrary function“
H	Time	100...36.000.000.000 µs (36 billion)

For details about the parameter and the arbitrary function refer to „3.11.10. Arbitrary function“.

Example CSV:

	A	B	C	D	E	F	G	H
1	20,00	30,00	5	5	90	50,00	50,00	50000000
2	30,00	20,00	5	5	90	50,00	50,00	30000000
3	0,00	0,00	0	0	0	0,00	0,00	1000
4	0,00	0,00	0	0	0	0,00	0,00	1000
5	0,00	0,00	0	0	0	0,00	0,00	1000
6	0,00	0,00	0	0	0	0,00	0,00	1000

The example shows that only the first two sequence points are configured, while all others are set to default values. The table could be loaded as WAVE\_U or WAVE\_I when using, for example, the model PSB 9080-120, because the values would fit both, voltage and current. The file naming, however, is unique. A filter prevents you from loading a WAVE\_I file after you have selected "Arbitrary --> U" in the function generator menu. The file would not be listed at all.

## ► How to load a sequence table from an USB stick:

1. Do not plug the USB drive yet or remove it.
2. Access the function selection menu of the function generator with MENU -> Function Generator -> Arbitrary -> U/I, to see the main screen of sequence point selector, as depicted to the right.

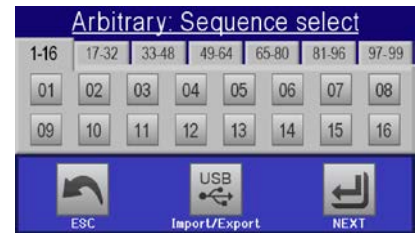

3. Tap touch area  , then  and follow the instructions on screen. If at least one valid files has been recognized (for file and path naming see above), the device will show a list of files to select from with  .

4. Tap touch area  in the bottom right corner. The selected file is then checked and loaded, if valid. In case it isn't valid, the device will show an error message. Then the file must be corrected and the steps repeated.

## ► How to save a sequence table to an USB stick:

1. Do not plug the USB stick yet or remove it.
2. Access the function selection menu of the function generator via MENU -> Function Generator -> Arbitrary

3. Tap on  , then  . The device will request you to plug the USB stick now.

4. After plugging it, the device will try to access the stick and find the folder HMI\_FILES and read the content. If there are already WAVE\_U or WAVE\_I files present, they will be listed and you can either select one for overwriting with  , otherwise select **-NEW FILE-** for a new file.

5. Finally save the sequence table with  .

### 3.11.11 Ramp function

Restrictions which apply particularly to this function:

- There is no preselection to which of both, source mode and sink mode, the function is applied to; the settings decide whether it's "source mode only", "sink mode only" or a mixture of both
- When applying the function to the voltage, the device can only switch to and work in sink mode if the external voltage on the DC terminal is higher than the highest point (offset + amplitude) of the wave and the current setting "I Sink" isn't 0

The following parameters can be configured for a ramp function:

Value	Range	Description
Ustart / Uend	0... $U_{Nom}$	Start/end value in U mode
Istart / Iend	$-I_{Nom}$ ... $+I_{Nom}$	Start/end value in I mode
t1	0,1 ms...36000 s	Time before ramp-up or ramp-down of the signal.
t2	0.1 ms...36000 s	Ramp-up or ramp-down time



*10 h after reaching the ramp end, the function will stop automatically (i.e.  $I = 0$  A, in case the ramp was assigned to the current), unless it has been stopped manually before.*

Schematic diagram:

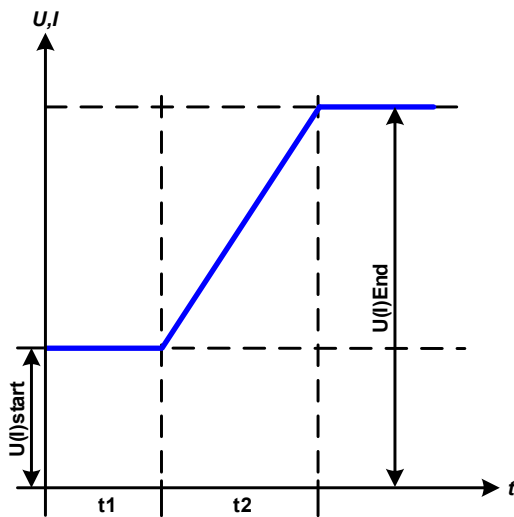

Application and result:

This function generates a rising or falling ramp between start and end values over the time  $t_2$ . Time  $t_1$  creates a delay before the ramp starts.

The function runs once and stops at the end value. To have a repeating ramp, function Trapezoid would have to be used instead (see 3.11.8).

Important to consider are the static values of  $U$  and  $I$  which define the start levels at the beginning of the ramp. It's recommended that these values are set equal to those for  $U_{start}/I_{start}$ , unless the load at the DC terminal, when in source mode, shouldn't be supplied with voltage before the start of the ramp or, when in sink mode, the external source shouldn't be loaded with current yet. In that case the static value should be set to zero.

### 3.11.12 IU table function (XY table)

The IU function offers the user the possibility to set a DC current dependant on the voltage being present on the DC terminal. The function is table driven with exactly 4096 values, which are distributed over the whole measured range of actual voltage in the range of 0...125% of the rated current. The table can either be uploaded from an USB stick through the front side USB port or via remote control (ModBus protocol or SCPI). The function is defined as:

IU function:  $I = f(U)$



*Uploading of a table from an USB stick must use text files in CSV format (\*.csv). Plausibility is checked on loading (values not too high, number of values correct) and possible errors reported in which case the table will not be loaded.*



The 4096 values in the table are only checked for size and count. If all the values were to be graphically plotted, a curve would be created which could include significant step changes in current. That could lead to complications for the connected load or source if, for example, the internal voltage measurement swings slightly so that the current jumps backwards and forward between two values in the table, which, in the worst case, could be 0 A and the maximum current.

#### 3.11.12.1 Loading IU tables from USB drive

The so-called IU value tables can be loaded from a file via a standard USB stick that is formatted as FAT32. In order to load the file, it has to meet following specifications:

- The file name always begins with IU (not case-sensitive)
- The file must be a text file of type Excel CSV (semicolon as separator) and must only contain one column with exactly 4096 values without gaps

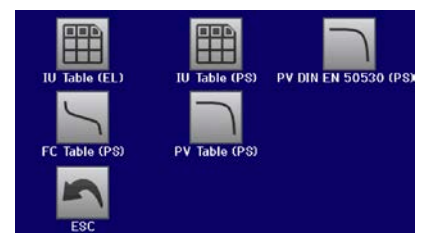

- Values with decimal places must use decimal separator that matches the selection in the general setting "USB file separator format", which also defines the decimal separator between dot and comma (US default should be dot)
- No value may exceed the nominal value of the device. For example, if you have a 120 A model, none of the 4096 values may be higher than 120 A (the adjustment limits from the device's front panel do not apply here)
- The file(s) has/have to be put inside a folder named HMI\_FILES in the root of the stick

If these specifications are not met, the device won't accept the file and put out an error message in the display. The USB drive may contain multiple IU files with different names and list them for the selection of one.



## ► How to load an IU table from an USB drive:

1. Do not plug the USB drive yet or pull it out if already plugged.
2. Open the function selection menu of the function manager with MENU -> Function Generator -> XY Table
3. In the next screen select the desired function with either „IU Table (EL)“ for running the function in sink mode or “IU Table (PS)” to run the function in source mode.
4. Configure the global parameters for U, I and P, if necessary.



5. Tap touch area  and plug the USB drive when requested, in order to select one out of X compatible files from the drive. In case the file isn't accepted, the device will report an error in the display and also tell what's wrong with the file.
6. Once the file is accepted, you will be requested to remove the USB drive.



7. Submit and load the function with  to start and control it as with other function (also see „3.11.4.1. Function selection and control“).

## 3.11.13 Simple PV (photovoltaics) function

### 3.11.13.1 Preface

This function runs exclusively in source mode and uses the integrated XY generator to let the power supply simulate solar panels or solar cells with certain characteristics, by calculating an IU table from four typical values.

While the function is running, the user can adjust a parameter called “Irradiance” to simulate different light situations.

The most important characteristics of a solar cell are:

- the short-circuit current ( $I_{SC}$ ), the maximum current at almost 0 V
- the open circuit voltage ( $U_{OC}$ ), which almost reaches its maximum value even in low light situations
- the maximum power point (MPP), at which the solar panel can provide the maximum output power

The voltage of the MPP (here:  $U_{MPP}$ ) lies typically 20% below  $U_{OC}$ , the current of the MPP (here:  $I_{MPP}$ ) lies typically 10% below  $I_{SC}$ . In case there are no definite values for the simulated solar cell available,  $I_{MPP}$  and  $U_{MPP}$  can be set to these typical values. The device limits the  $I_{MPP}$  value to  $I_{SC}$  as upper limit, the same applies to  $U_{MPP}$  and  $U_{OC}$ .

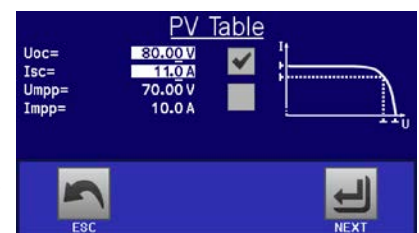

### 3.11.13.2 Safety notices



Due to high capacities on the DC terminal of some models of this series, not every available solar inverter can be operated without problems. Check the technical specifications of the solar inverter and probably contact the manufacturer for an evaluation.

### 3.11.13.3 Usage

In the PV table function, which is based upon the XY generator with IU characteristics, the MPP is defined by the two adjustable parameters  $U_{MPP}$  and  $I_{MPP}$  (also see diagram below). These parameters are usually stated in data sheets of solar panels and have to be entered here.

The following parameters can be set for the PV table function:

Value	Range	Description
$U_{oc}$	$U_{MPP} \dots \text{rated device voltage}$	Open circuit voltage at no load
$I_{sc}$	$I_{MPP} \dots \text{rated device current}$	Short-circuit current at max. load and low voltage
$U_{MPP}$	0 V... $U_{oc}$	DC output voltage at the MPP
$I_{MPP}$	0 A... $I_{sc}$	DC output current at the MPP

Schematic diagram:

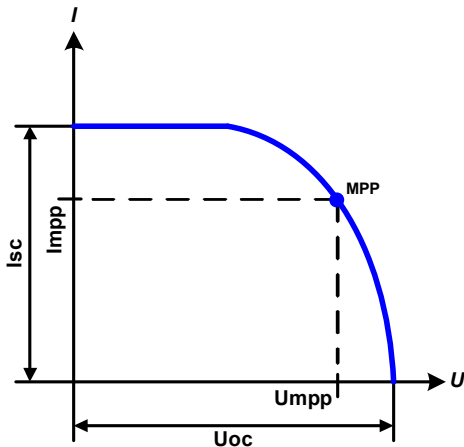



Application and result:

Adjust all four parameters on screen to the desired values.

While the simulation is running, the user can see from the actual values (voltage, current, power) of the DC output, where the operating point of the power supply or of the simulated solar panel is. The adjustable value **Irradiance** (0%...100% in 1% steps, see screenshot below) helps to simulate different light situations from darkness (no power output) to the minimal amount of light that is required to make the panel provide full power.

Varying this parameter shifts the MPP and the PV curve along the Y axis. Also see diagram to the right. The value Irradiance is here used as a factor for the current  $I_{mpp}$ . The curve itself isn't permanently re-calculated.

## ► How to configure the PV table

1. In the function generator menu tap on , then  and then .
2. Adjust the four parameters as required for the simulation.
3. Do not forget to adjust the global limits for voltage and power in

the next screen which you can access with touch area . The voltage (U) setting should be at least as high as  $U_{oc}$ , or higher.

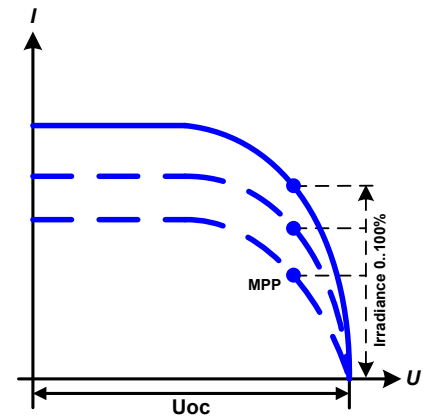

4. After setting the values for the required signal generation, tap on touch area .

While loading, the IU function is calculated and sent to the internal XY generator. After this, the function is ready to run.



*The function can be saved to USB stick as table after every calculation, as well as read via any of the digital interfaces.*

From the screen where the XY function generator is controlled manually (start/stop), you can go back to the first screen of PV table function and use the formerly locked touch area to save the table to USB drive. In order to do so, follow the on-screen instructions. The table can be used to analyse the values or to visualise it in Excel or similar tools.

## ► How to work with the PV table function

1. With an appropriate load connected, for example a solar inverter, start the function as described in 3.11.4.1.
2. Adjust value **Irradiance** with any rotary knob between 100% (default) and 0%, in order to reproduce different light situations for the simulated panel. The actual values on the display indicate the working point and can show whether the simulation has arrived at the MPP or not.
3. Stop the function run anytime as described in 3.11.4.1.

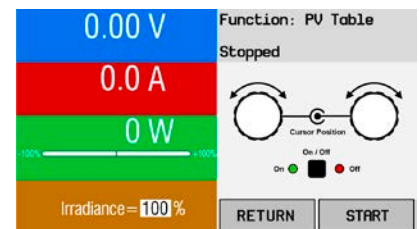

3.11.14 FC table function (fuel cell)

3.11.14.1 Preface

The FC table function is used to simulate the characteristics of voltage and current of a fuel cell. This is achieved by setting up some parameters which define points on a typical fuel cell curve, which is then calculated as UI table and passed to the internal function generator.

The user has to adjust value for four support points. The device will request to enter them step by step, indicating the actual point on screen with small graphics. When finished, these points will be used to calculate the curve.

Generally, following rules apply when setting up those values:

- $U_{Point1} > U_{Point2} > U_{Point3} > U_{Point4}$
- $I_{Point4} > I_{Point3} > I_{Point2} > I_{Point1}$
- Values of zero are not accepted

It means, the voltage has to decrease from point 1 to point 4, while the current has to increase. In case the rules are not followed, the device will reject the values with an error and reset them to 0.

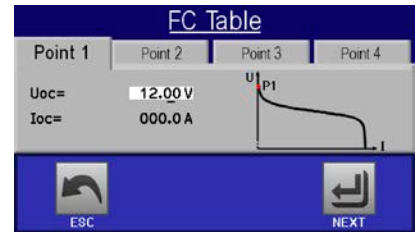
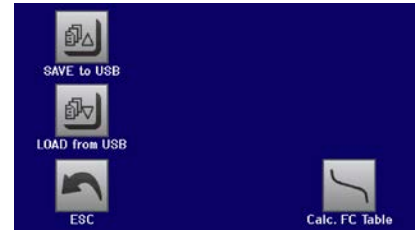

3.11.14.2 Usage

The following parameters can be set for the FC table function:

Value	Range	Description
Point 1: Uoc	0 V...U <sub>Nom</sub>	Maximum voltage of the cell (open circuit voltage at no load)
Points 2+3: U	0 V...U <sub>Nom</sub>	Voltage and current define the position of these two points in the XY coordinate system, which represent two supporting points on the curve to be calculated
Points 2+3: I	0 A...I <sub>Nom</sub>	
Point 4: Isc	0 A...I <sub>Nom</sub>	Maximum output current of the fuel cell (short-circuit situation)
U	0 V...U <sub>Nom</sub>	Global voltage limit
P Source	0 W...P <sub>Nom</sub>	Global power limit, must not be 0 in order for the function to run as expected

 All these parameters all freely adjustable and thus an unrealistic curve could result. In some situations, the device would show a "Calculation error" when tapping the next point to configure. In this situation, check your settings, adjust and try again.

Schematic diagram:

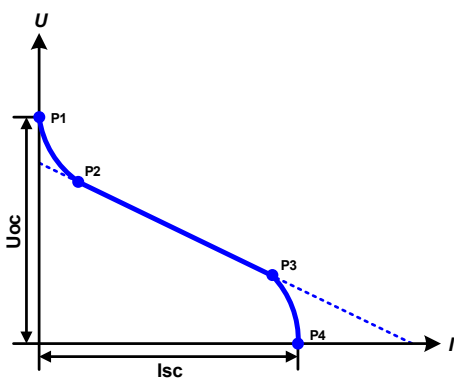





Application and result:

After setting up the four supporting points Point 1 thru Point 4, whereas Point 1 is defined by Uoc and 0 A and Point 4 is defined by Isc and 0 V, the device will calculate the function as XY table and load it to the XY generator.

Depending on the load current, which can be between 0 A and Isc, the device will set a variable output voltage, whose progress between 0 V and Uoc should result in a curve similar to the one depicted to the left.

The slope between Point 2 and Point 3 is depending on the values adjusted for Point 2 and Point 3 and can be freely modified as long as Point 3's voltage is lower than the one of Point 2 and Point 3's current is higher than the one of Point 2.

► How to configure the FC table

1. In the function generator menu tap on  , then  and then  .
2. Adjust the parameters of the four supporting points, as required for the simulation.
3. Do not forget to adjust the global limits for voltage and power in the screen which you can access with touch area  .
4. After setting the values for the required signal generation, tap on touch area  .

After the function has been calculated and loaded to the internal XY generator, the simulation is ready to start.



The function can be saved to USB stick as table, as well as read via any of the digital interfaces. In remote control, the function can't be loaded or controlled.

From the screen where the XY function generator is controlled manually (start/stop), you can go back to the first screen of the FC table function and use the formerly locked touch area to save the table to USB drive. In order to do so, follow the on-screen instructions. The table can be used to analyse the values or to visualise it in Excel or similar tools.

### ► How to work with the FC table function

1. With an appropriate load connected, for example a DC-DC converter, start the function as described in 3.11.4.1.
2. The output voltage will be set depending on the load current, which is defined by the connected load, and will decrease with increasing current. Without any load, the voltage will rise to the adjusted  $U_{oc}$  value.
3. Stop the function run anytime as described in 3.11.4.1.

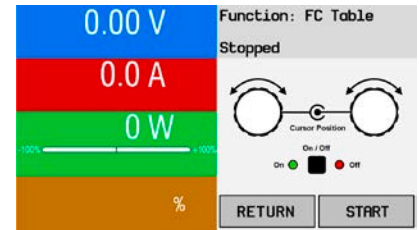

## 3.11.15 Extended PV function according to EN 50530

### 3.11.15.1 Introduction

This extended PV table function according to standard EN 50530 is used to simulate solar panels in order to test and rate solar inverters. It's available since firmware versions KE 2.25 and HMI 2.04 and offers manual configuration and control, as well as remote control. It's also based on the XY generator, same as the simple PV table function from 3.11.13, but enables more specific tests and evaluations due to adjustable parameters. Which parameters are available is explained below. The impact of the parameters on the PV curve and the simulation is described in the norm paper of EN 50530, which users can refer to in case more detailed description is required. This section only deals about configuration and control of the PV simulation.

### 3.11.15.2 Differences to the basic PV function

The extended PV function has five additional or different characteristics compared to the simple PV function:

- The simulation distinguishes between a single test run and an automatic test run, called day trend, which is based upon a user-defined curve built from up to 100,000 points
- There are two invariable and one variable panel technology available to choose from
- There are more parameters available to adjust during runtime
- It allows for data recording during runtime and to save the data either to USB stick or read via digital interface
- It allows to select between two different parameter sets to adjust during runtime

### 3.11.15.3 Technologies and technology parameters

When configuring the PV simulation it's required to select the solar panel technology to simulate. The technologies **cSi** and **Thin film** are invariable in their parameters, while technology **Manual** is variable in all parameters, but within specific limits. This allows for the variation of the simulation and when copying the fixed parameter values from **cSi** or **Thin film** to **Manual**, it even enables their variation as well.

One advantage of the invariable technologies is that their technology parameters are automatically set to their defined defaults in the configuration procedure.

Overview of the technology parameters used in the PV curve calculation and their defaults:

Abbr.	Name	Manual	cSi	Thin film	Unit
<b>FFu</b>	Fill factor for voltage	>0...1 (0.8)	0.8	0.72	-
<b>FFi</b>	Fill factor for current	>0...1 (0.9)	0.9	0.8	-
<b>Cu</b>	Scaling factor for $U_{oc}$ <sup>(1)</sup>	>0...1 (0.08593)	0.08593	0.08419	-
<b>Cr</b>	Scaling factor for $U_{oc}$ <sup>(1)</sup>	>0...1 (0.000109)	0.000109	0.0001476	m <sup>2</sup> /W
<b>Cg</b>	Scaling factor for $U_{oc}$ <sup>(1)</sup>	>0...1 (0.002514)	0.002514	0.001252	W/m <sup>2</sup>
<b>alpha</b>	Temperature coefficient for $I_{sc}$ <sup>(2)</sup>	>0...1 (0.0004)	0.0004	0.0002	1/°C
<b>beta</b>	Temperature coefficient for $U_{oc}$ <sup>(1)</sup>	-1...<0 (-0.004)	-0.004	-0.002	1/°C

(1)  $U_{oc}$  = Open circuit voltage of a solar panel

(2)  $I_{sc}$  = Short-circuit current (=max. current) of a solar panel

## 3.11.15.4 Simulation mode

Apart from the panel technology there is also a simulation mode to select. Four options:

Mode <b>U/I</b>	Controllable simulation. Voltage ( $U_{MPP}$ , in V) and current ( $I_{MPP}$ , in A) in the maximum power point (MPP) are variable during runtime. The purpose of this mode is to directly shift the MPP into various directions.
Mode <b>E/T</b>	Controllable simulation. During runtime, the irradiation (E from german "Einstrahlung", in W/m <sup>2</sup> ) and surface temperature (T, in °C) of the simulated solar panel are adjustable. This also impacts the curve and the resulting MPP. The purpose of this mode is to analyse the impact of temperature and/or irradiation on the performance of a solar panel.
Mode <b>DAY U/I</b>	Automatic simulation run, processing a day trend curve consisting of up to 100,000 points defined by values for $U_{MPP}$ , $I_{MPP}$ and time.
Mode <b>DAY E/T</b>	Automatic simulation run, processing a day trend curve consisting of up to 100,000 points defined by values for irradiation, temperature and time.

## 3.11.15.5 Day trend

The so-called day trend is a special simulation mode for long-term tests. It processes a curve consisting of up to 100,000 user-definable points. For every processed point on that curve, the PV curve is calculated anew.

Every point is defined by 3 values of which one is the dwell time. When defining long dwell times the day trend curve can be supported by an interpolation feature which can be optionally activated. It will calculate and set intermediate points between two succeeding curve points. Hence it should be considered to run the day trend with or without interpolation.

The day curve points have to be loaded into the device, either from a CSV file on USB stick or via digital interface. The user selects the number of points according to the requirements of the simulation.

Formats of the CSV files to load from USB stick when manually configuring the function:

- For **Mode DAY E/T** (required file name format: PV\_DAY\_ET\_<arbitrary\_text>.csv)

	A	B	C	D
1	1	100	25	300000
2	2	101	25	2000
3	3	102	25	2000
4	4	103	25	2000
5	5	104	25	2000
6	6	105	25	2000
7	7	106	25	2000
8	8	107	25	2000
9	9	108	25	2000

Column A = **Index**

An ascending number between 1 and 100,000 (the first empty index will cause the simulation to stop)

Column B = **Irradiation** (E) in W/m<sup>2</sup>

Allowed range: 0...1500

Column C = **Temperature** (T) in °C

Allowed range: -40...80

Column D = **Dwell time** in milliseconds (ms)

Allowed range: 500...1.800.000

- For **Mode DAY U/I** (required file name format: PV\_DAY\_UI\_<arbitrary\_text>.csv)



Attention! The values in columns B and C are real values which must not exceed the ratings of the device or the device will neglect to load the file.

	A	B	C	D
1	1	63.5	120.3	500
2	2	63.6	121.1	500
3	3	63.7	121.9	500
4	4	63.8	122.7	500
5	5	63.9	123.5	500
6	6	64	124.3	500
7	7	64.1	125.1	500
8	8	64.2	125.9	500
9	9	64.3	126.7	500

Column A = **Index**

An ascending number between 1 and 100,000 (the first empty index will cause the simulation to stop)

Column B = **Voltage**  $U_{MPP}$  in V

Allowed range: 0...rated output voltage of the device

Column C = **Current**  $I_{MPP}$  in A

Allowed range: 0...rated output current of the device

Column D = **Dwell time** in milliseconds (ms)

Allowed range: 500...1.800.000



The number format and the column separator in the CSV files is determined by the regional settings of the PC or the software used to create the files. The format must match the selection for the device setting "USB file separator format" in the General Settings menu of the device, else the device would neglect loading the file. For example, an american Excel should by default use the dot as decimal separator and the comma as column separator, which would match the selection "USB file separator format = US".

**3.11.15.6 Interpolation**

The interpolation feature can calculate and set intermediate steps when running the PV function in day trend mode, i. e. **DAY E/T** or **DAY U/I**. The calculation is always done between two succeeding points on the day trend curve. The dwell time of every curve point is adjustable between 500 and 1,800,000 milliseconds (see above, format of the day trend data file). While there are no extra points calculated when using the minimum time of 500 ms, following applies to higher dwell time definitions:

- The number of intermediate steps is determined from the dwell time and spread as equally as possible, where any of the steps can have its own dwell time between 500 and 999 ms
- The intermediate steps also respect the slope between the current and the next day trend curve point and thus every step also includes a corresponding value alteration

Visualisation:

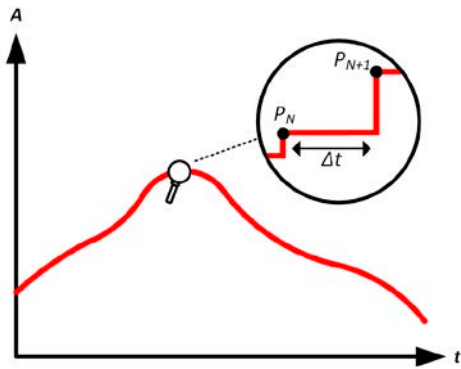

Without interpolation - the curve results in steps

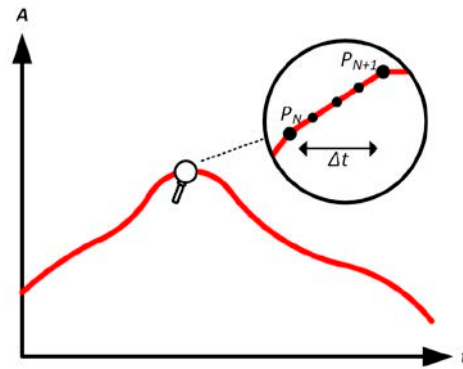

With interpolation - the curve remains linear

An example: the dwell time of the 3450<sup>th</sup> curve point is defined as 3 minutes, which is 180 seconds. There will be  $180 / 0.5 - 1 = 359$  intermediate steps calculated and set until reaching the 3451<sup>st</sup> point. In mode DAY U/I the MPP voltage changes from 75 V to 80 V and the MPP current changes from 18 A to 19 A. When calculated, this would mean a ΔU/Δt of 27.7 mV/s and a ΔI/Δt of 5.5 mA/s. Depending on the device in use, such small steps in voltage or current may not be doable. However, the device would try to set the first intermediate step with 75.0138 V and 18.0027 A.

**3.11.15.7 Data recording**

There is the option to record data during the simulation run, in any mode. The data can be stored to USB stick once the simulation is finished or read via digital interface, which even allows for reading the data while the simulation is still running.

As long as the simulation is running, the device will record one data set every 100 ms into an internal buffer. This interval isn't adjustable. The max. number of data sets, here also called indexes, is 576,000. This results in a max. record time of 16 hours. The indexes are internally counted with every new record. When reaching the max. number, the index will restart from 1, overwriting former data. Every index will contain 6 values.

When configuring the PV simulation, the recording feature is locked at first (button greyed out). Only when stopping the simulation and leaving the control screen back to the configuration, the button becomes accessible. It then allows to store a CSV with a specific number of rows. This number depends on the current index counter. Contrary to remote control where it's possible to address every index of the max. 576,000 the save to USB feature will always store all indexes between 1 and the counter. Every next simulation run also resets the counter.

CSV file format when saving the recorded data to USB stick (in the example all values are with unit):

	A	B	C	D	E	F	G
1	Index	U actual	I actual	P actual	Umpp	Impp	Pmpp
2	1	0,29V	0,000A	0,0W	0,00V	0,000A	0,0W
3	2	0,29V	0,000A	0,0W	0,00V	0,000A	0,0W
4	3	0,29V	0,000A	0,0W	0,00V	0,000A	0,0W
5	4	0,29V	0,000A	0,0W	0,00V	0,000A	0,0W
6	5	0,30V	0,000A	0,0W	0,00V	0,000A	0,0W
7	6	0,28V	0,000A	0,0W	0,00V	0,000A	0,0W
8	7	0,28V	0,000A	0,0W	0,00V	0,000A	0,0W
9	8	0,28V	0,000A	0,0W	0,00V	0,000A	0,0W

**Index** = Ascending number

**Uactual** = Actual voltage on the DC output

**Iactual** = Actual current on the DC output

**Pactual** = Actual power on the DC output

**Umpp / Impp / Pmpp** = Voltage, current and power in the MPP of the currently calculated PV curve

## 3.11.15.8 Configuration step by step

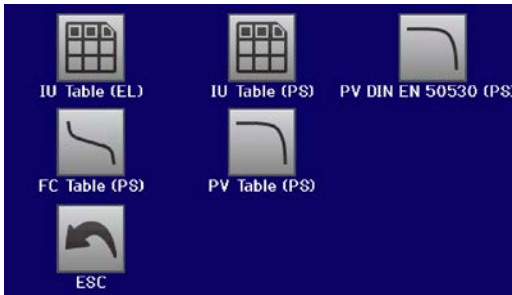

### Starting point

In MENU->Function Generator->2nd page->XY-Table you will find the PV functions. Select **PV DIN EN 50530 (PS)**.



### Step 1: Technology selection

The extended PV function requires to select the panel technology of the solar panel which is going to be simulated. In case **cSI** or **Thin Film** don't match your requirements or you are not sure about their technology parameters, select **Manual**.

When selecting **Thin film** or **cSI** the configuration continues with **Step 2**.

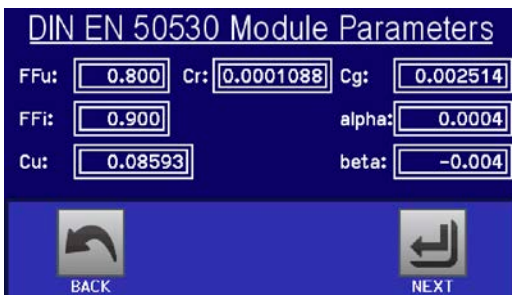

### Step 1-1: Adjust technology parameters

If technology **Manual** was selected in the previous screen, all displayed technology parameters can be adjusted by tapping on them and entering the desired value. It's recommended to adjust these values very carefully, because wrong settings can result in a PV curve which doesn't work as expected.

When resetting the device, these values are reset to defaults which are the same as with technology **cSI**. Also see the overview in 3.11.15.3. It means they don't necessarily have to be adjusted. If any of the other technologies was selected, this screen would be skipped and these parameters set to the defined values.

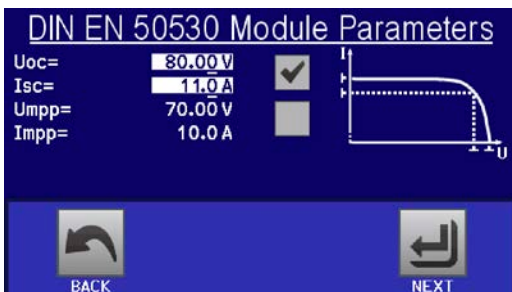

### Step 2: Enter the solar panel's base parameters

The open circuit voltage ( $U_{OC}$ ), the short-circuit current ( $I_{SC}$ ), as well as voltage ( $U_{MPP}$ ) and current ( $I_{MPP}$ ) in the expected MPP are the base parameters to calculate a PV curve from.  $U_{OC}$  and  $I_{SC}$  are upper limits which are usually read from the data sheet of a solar panel and entered here for the simulation. Two parameters each are connected via the fill factors:

$$U_{MPP} = U_{OC} \times FFu \quad / \quad I_{MPP} = I_{SC} \times FFi$$



### Step 3: Select simulation mode

For a description of the available simulation modes see 3.11.15.4.

Furthermore, the recording feature can be enabled (=activated) here. The recorded data can later be stored to USB drive as CSV file with button **SAVE records to USB**, after returning to this screen from the simulation run. Also see section 3.11.15.7.

When selecting **E/T** or **U/I** the configuration continues with **Step 4**.

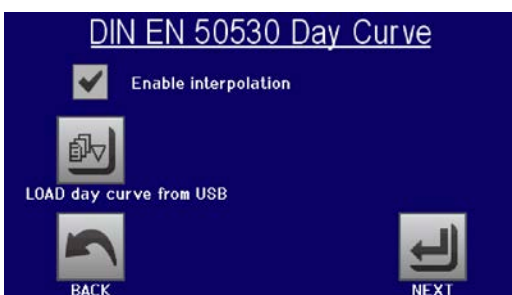

### Step 3-1: Load day trend data

If mode **DAY E/T** or **DAY U/I** was selected this additional screen will appear where you can load the required day trend data (1-100,000 points) with button **LOAD day curve from USB** from USB stick and from a CSV file with a specific format (see 3.11.15.5) and name (see 1.9.6.5).

There is furthermore the option to enable (=activate) the interpolation feature (see 3.11.15.6).



## Step 4: Global limits

This configuration screen allows to limit voltage and power globally for the simulation. The current, in this table based simulation, is taken from the calculated PV table which also is an IU table.

The output voltage of the power supply is already defined by setting up  $U_{oc}$  in step 2, so it's recommended to adjust value U to same or higher, else the PV curve may not be working as expected. The power shouldn't be limited at all.

Recommendation: leave both values untouched

The configuration will be finished and the settings submitted with button . The function generator would then switch to control mode.

### 3.11.15.9 Controlling the simulation

After loading the configured parameters the FG will switch to control mode. Now the simulation can be started with either the "On/Off" button or touch area .

According to the configured simulation mode, the orange-brown display area would show the adjustable simulation parameters, which could only be modified via direct input, not by the rotary knobs, because with every step of the knob the curve would be re-calculated.

The screen example on the right shows simulation mode **E/T**.

In case any of the day trend modes would have been configured, the display area would be empty. These modes run automatically once started and will stop when the total time of all points' dwell time is reached. The other modes, **E/T** and **U/I**, would only stop by user interaction or due to a device alarm.

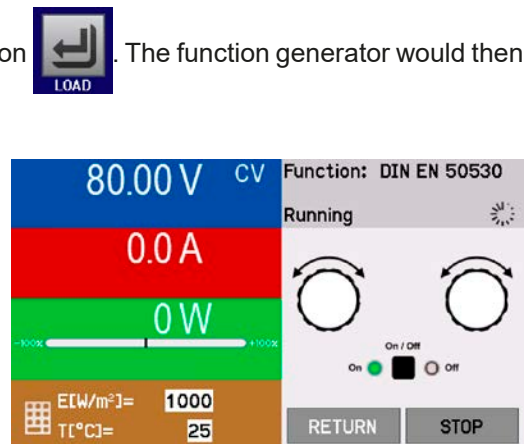

### 3.11.15.10 Stop criteria

The simulation run could unintentionally stop due to several reasons:

1. A device alarm occurred, which would switch off the DC output (PF, OVP, OCP, OPP)
2. An user event occurred whose action has been defined to cause an alarm, which means to switch off DC
3. Day trend mode has finished

Situation 2 can be avoided by carefully setting up other parameters, unrelated to the function generator. With the simulation stop in all three situation the data recording would also stop.

### 3.11.15.11 Test analysis

After simulation stop by whatever reason recorded data can be saved to USB stick or read via digital interface, of course only if data recording has been activated in the configuration. Activating the data recording feature during the simulation run isn't possible when manually controlling the FG, but in remote control. When saving to USB stick, it would always save all data recorded until the current index counter. Via digital interface there is the option to read any portion of the data, which will also have an impact on the time required to read the data.

The data can later be used to visualise, analyse and determine characteristics of the simulated solar panel and also of the solar inverter which is usually used as load when running such tests. More details can be found in the standard paper.

### 3.11.15.12 Reading the PV curve

The last PV curve (or table) which has been calculated during the simulation run can later be read from the device via digital interface (partly or completely) or stored to USB stick. This can serve to verify the adjusted parameters. When running mode DAY E/T or DAY U/I this makes less sense, because there the curve would be re-calculated with every processed index and the read curve would always be the one belonging to the last day trend curve point.

When reading the PV table, you will receive up to 4096 current values. The table data could be visualised in an XY diagram in tools like Excel.



3.11.16 Battery test function

The purpose of the battery test function is to charge and discharge various battery types in industrial product tests or laboratory applications. Additionally, the so-called dynamic test mode combines a certain flow of charge and discharge phases while offering full configurability, for example which phase starts first or how much time in between both (pause) phases has to elapse or how often the charge/discharge cycle is going to be repeated.

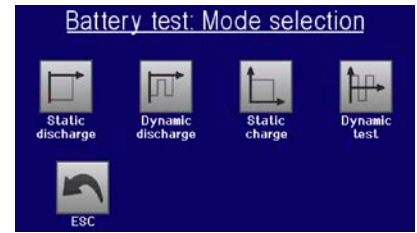

There is a choice between modes “**Static discharge**” (constant current), “**Dynamic discharge**” (pulsed current), “**Static charge**” (constant current) and “**Dynamic test**” (flow of charge/discharge).

In **static discharge** mode which by default runs in constant current (CC), the settings for power or resistance can also let the device run the function in constant power (CP) or constant resistance (CR). Like with the normal operation of the device the set values determine what regulation mode (CC, CP, CR) will be in effect. If, for example, CP operation is projected, the set value of current should be set to maximum and resistance mode should be turned off, so that both don't interfere. For a projected CR operation it's similar. Current and power should then be set to maximum.

For **dynamic discharge** mode there is also a power setting, but it can't be used to run the dynamic battery test function in pulsed power mode or at least the result would not be as expected. It's recommended to always adjust the power value according to the test parameters, so it doesn't interfere with the pulsed current.

*When discharging with high currents and in dynamic mode, it may happen that the battery voltage shortly drops below the discharge end voltage (U-DV) threshold and the test will unintentionally stop. Here it's recommended to adjust U-DV accordingly.*

Graphical depiction of both discharging modes:

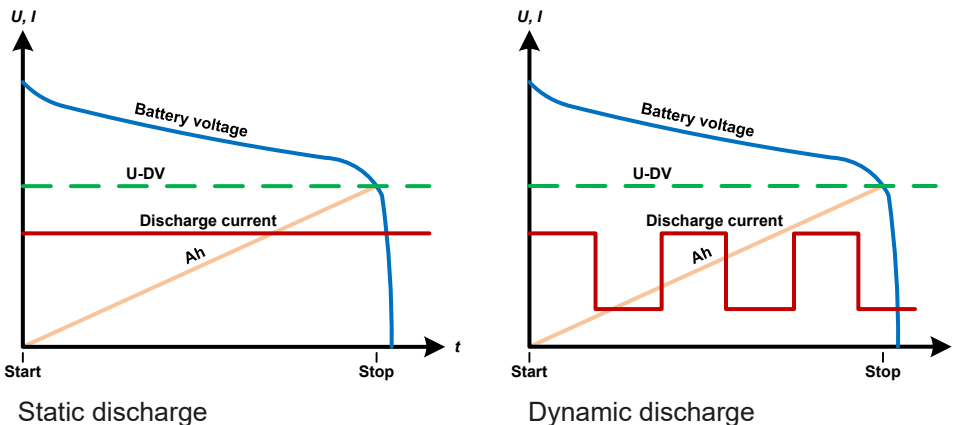

The **static charge** basically follows the charging profile used for lead-acid batteries. The battery is charged with a constant current until it reaches either a specified charging end voltage or a charging end time or when the charging current falls below the specified charging end current threshold.

Graphical depiction of the static charging mode:

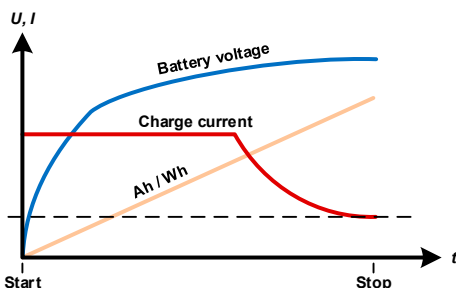

The fourth mode is called “**Dynamic test**” and combines “**Static discharge**” with “**Static charge**” in one flow. The same parameters for the single test parts are available, plus some extra for the flow. You can, for example, select what comes first, charge or discharge. There is also an option to cycle the test, i. e. repeat 1 to 999 times or infinitely and you can define a resting period which elapsed before the next cycle.

### 3.11.16.1 Settings for the static discharge mode

The following parameters can be configured for the static discharge battery test function:

Value	Range	Description
I	0...I <sub>Nom</sub>	Maximum discharge current (in Ampere)
P	0...P <sub>Nom</sub>	Maximum discharge power (in Watt)
R	R <sub>Min</sub> ..R <sub>Max</sub>   OFF	Maximum discharge resistance in Ω

### 3.11.16.2 Settings for the dynamic discharge mode

The following parameters can be configured for the dynamic discharge battery test function:

Value	Range	Description
I <sub>1</sub>	0...I <sub>Nom</sub>	Upper/lower current setting for pulsed operation (the higher value of both is automatically used as upper level)
I <sub>2</sub>	0...I <sub>Nom</sub>	
P	0...P <sub>Nom</sub>	Maximum discharge power (in Watt)
t <sub>1</sub>	1 s ... 36000 s	t <sub>1</sub> = Time for the upper level of the pulsed current (pulse) t <sub>2</sub> = Time for the lower level of the pulsed current (pause)
t <sub>2</sub>	1 s ... 36000 s	

### 3.11.16.3 Settings for the static charge mode

The following parameters can be configured for the static charge battery test function:

Value	Range	Description
U <sub>Charge</sub>	0...U <sub>Nom</sub>	Charging voltage (in Volt)
I <sub>Charge</sub>	0...I <sub>Nom</sub>	Maximum charging current (in Ampere)

### 3.11.16.4 Settings for the dynamic test mode

The following parameters can be configured for the dynamic test battery test function:

Value	Range	Description
I <sub>Charging end current</sub>	0...I <sub>Nom</sub>	Threshold (in Ampere) to stop charging
I <sub>Charge</sub>	0...I <sub>Nom</sub>	Static charging current (in Ampere)
U <sub>Charge</sub>	0...U <sub>Nom</sub>	Charging voltage (in Volt)
t <sub>1</sub>	1 s ... 36000 s	Period for the charging test part (max. 10 h)
U <sub>Discharge end voltage</sub>	0...U <sub>Nom</sub>	Voltage (in Volt) to discharge the battery to (U-DV)
I <sub>Discharge</sub>	0...I <sub>Nom</sub>	Static discharging current (in Ampere)
t <sub>2</sub>	1 s ... 36000 s	Period for the discharging test part
Start with	Charge   Discharge	Determines whether the test starts with charging or discharging part
Test cycles	1...999   ∞	Number of cycles to run the complete test
Rest time	1 s ... 36000 s	Time to rest the test before the next cycle

### 3.11.16.5 Other settings

These settings are used in all test modes, some with the same meaning but different name:

Value	Range	Description
Charging end current	0...I <sub>Nom</sub>	Threshold (in Ampere) to stop charging in static charge mode
Discharge end voltage	0...U <sub>Nom</sub>	Threshold (on Volt) to let the discharging stop in static discharging or dynamic discharging modes
Charge time Discharge time Battery test time	0...10 h	Test time after which the test can stop automatically. This stop criteria is optional, it means that single tests can also run longer than 10 h.
Charge capacity Discharge capacity	0...99999.99 Ah	Threshold for the max. capacity to consume from or feed to the battery and after which the test can stop automatically. This is optional, so that also more battery capacity can be consumed or supplied.

Value	Range	Description
Action	NONE, SIGNAL, End of test	Separately defines an action for the settings „Discharge time“, “Charge time”, “Discharge capacity“, “Charge capacity” and “Battery test time”. It determines what shall happen with the test if any of the adjusted limits is reached: NONE = No action, test will continue SIGNAL = A text “Time limit” or “Ah limit” will be displayed on screen to notify about reaching a limit, but the test will continue End of test = The test will stop
Enable USB logging	on/off	By setting the check mark, USB logging is enabled and will record data on a properly formatted USB stick, if plugged in to the front USB port. The recorded data differs from the USB log data recorded during “normal” USB logging in all other operation modes of the device.
Logging interval	100 ms - 1 s, 5 s, 10 s	Writing interval for USB logging

### 3.11.16.6 Displayed values

During the test run, the display will show various values and statuses:

- Actual battery voltage on the DC terminal
- Discharge voltage  $U_{DV}$  in V (only in discharge mode)
- Charge voltage in V (only in charge mode)
- Actual discharge or charge current
- Actual power
- Total battery capacity (charging & discharging)
- Total battery energy (charging & discharging)
- Elapsed time
- Regulation mode (CC, CP, CR, CV)

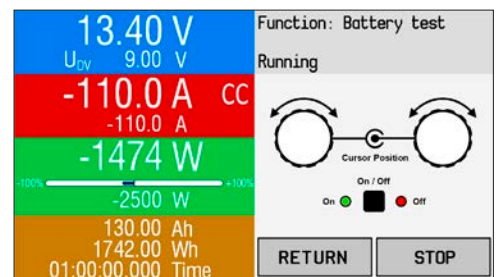

Figure 9 - Example of static discharge

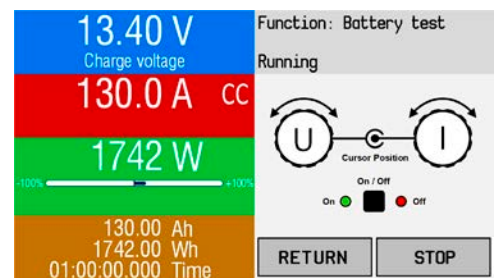

Figure 10 - Example of static charge

### 3.11.16.7 Data recording (USB logging)

At the end of the configuration of all test modes there is the option to enable the USB logging feature. With an USB stick plugged and formatted as required (see 1.9.6.5), the device can record data during the test run directly to the stick and in the defined interval. Active USB logging is indicated in the display with a small diskette symbol. After the test has stopped, the recorded data will be available as text file in CSV format.

Log file format example from static discharge mode:

	A	B	C	D	E	F	G
1	Static:Uset	Iset	Pset	Rset	DV	DT	DC
2	0,00V	0,00A	1200W	OFF	0,00V	10:00:00	99999,00Ah
3							
4	Uactual	Iactual	Pactual	Ah	Wh	Time	
5	0,34V	0,00A	0W	0,00Ah	0,00Wh	00:00:00,800	
6	0,28V	0,00A	0W	0,00Ah	0,00Wh	00:00:01,800	
7	0,28V	0,00A	0W	0,00Ah	0,00Wh	00:00:02,800	
8	0,28V	0,00A	0W	0,00Ah	0,00Wh	00:00:03,800	

Static = Selected test mode  
 Iset = Discharging current  
 Pset = Max. power  
 Rset = Desired resistance  
 DV = Discharge end voltage  
 DT = Discharge end time  
 DC = Discharge end capacity  
 U/I/Pactual = Actual values  
 Ah = Consumed battery capacity  
 Wh = Consumed energy  
 Time = Elapsed test time



Regardless the setting for the recording interval, the values “Ah” and “Wh” are only calculated by the device once per second. When using an interval setting of < 1 s, several identical values of Ah and Wh are written into the log file.

## 3.11.16.8 Possible reasons for battery test stop

The battery test function run can be stopped by different reasons:

- Manual stop on the HMI with button STOP
- After the max. test time has been reached and action "End of test" was set for it
- After the max. battery capacity to consume has been reached and action "End of test" was set for it
- Any device alarm which would also switch off the DC input, like OT
- Reaching the threshold  $U_{DV}$  (discharge voltage)
- Reaching the threshold for charging end current



*When the dynamic is running, some of the above items, such as "Reaching threshold  $U_{DV}$ " will only stop the currently running test part, i. e. charging or discharging, but not the full test. The test would then immediately continue with the next part, if at least one is still to proceed.*

3.11.17 MPP tracking function

MPP stands for the maximum power point (see principle view to the right) on the power curve of solar panels. Solar inverters, when connected to such panels, constantly track this MPP once it has been found.

The device imitates this behavior in sink mode. It can be used to test even huge solar panels without having to connect a usually big solar inverter device which also requires to have a load connected to its AC output. Furthermore, all MPP tracking related parameters of the load can be adjusted and it's thus more flexible than an inverter with its limited DC input range.

For evaluation and analysis purposes, the device can also record measured data, i. e. DC input values such as actual voltage, current or power, to USB stick or provide them for reading via digital interface.

The MPP tracking function offers **four modes**. Unlike with the manual handling of other functions, values for the MPP tracking are only entered by direct input via the touch screen.

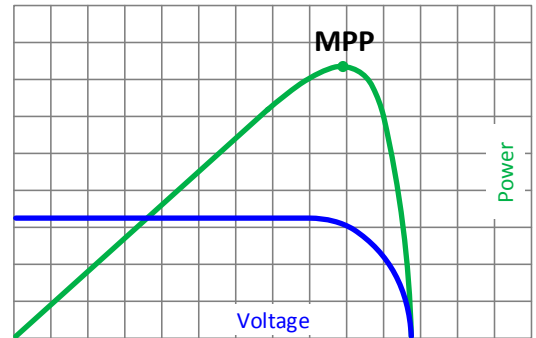
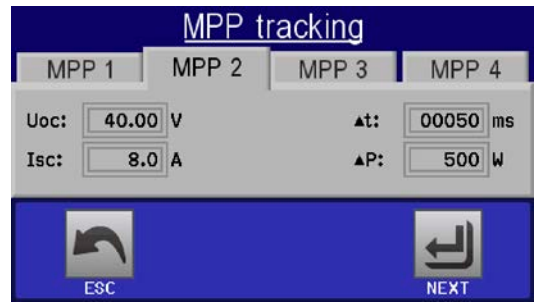

3.11.17.1 Mode MPP1

This mode is also called “**find MPP**”. It's the simplest option to have the device find the MPP of a connected solar panel. It requires to set only three parameters. Value  $U_{OC}$  is necessary, because it helps to find the MPP quicker as if the device would start at 0 V or maximum voltage. Actually, it would start at a voltage level slightly above  $U_{OC}$ .

$I_{SC}$  is used as an upper limit for the current, so the device would not try to draw more current than the panel is specified for. Following parameters can be configured for tracking mode **MPP1**:

Value	Range	Description
$U_{OC}$	0... $U_{Nom}$	Voltage of the solar panel when unloaded, taken from the panel specs
$I_{SC}$	0... $I_{Nom}$	Short-circuit current, taken from the panel specs
$\Delta t$	5 ms...60000 ms	Time between two tracking attempts when finding the MPP

Application and result:

After the three parameters have been set, the function can be started. As soon as the MPP has been found, the function will stop and switch off the DC input. The acquired MPP values of voltage ( $U_{MPP}$ ), current ( $I_{MPP}$ ) and power ( $P_{MPP}$ ) would then be shown in the display.

The time of a function run depends on the parameter  $\Delta t$ . Even with the minimum setting of 5 ms one run usually takes already a few seconds.

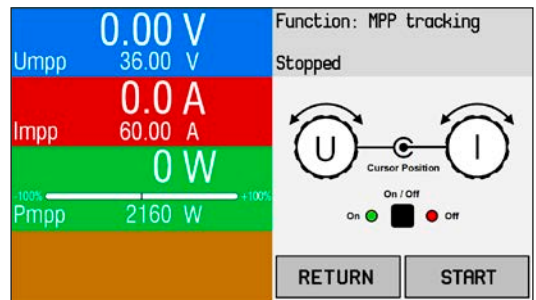

3.11.17.2 Mode MPP2

This mode tracks the MPP, so it's closest to the operation of a real solar inverter. Once the MPP is found, the function won't stop, but try to track the MPP permanently. Due to the nature of solar panels this can only be done below the level of the MPP. As soon as this point is reached, the voltage starts to sink further and so does the actual power. The additional parameter  $\Delta P$  defines how much the power may fall before the direction is reversed and the voltage starts to rise again until the load reaches the MPP. The result are zigzag shaped curves of both, voltage and current.

Typical curves are shown in the picture to the right. For the example the  $\Delta P$  was set to a quite small value, so the power curve looks almost linear. With a small  $\Delta P$  the load would always track close to the MPP.

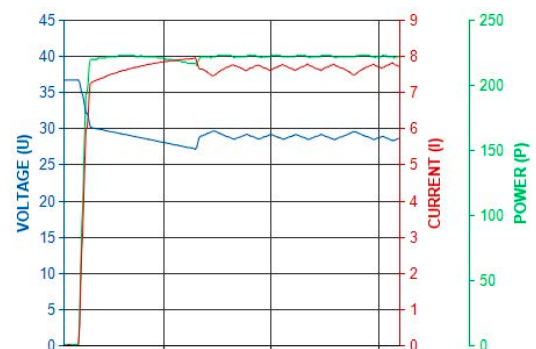

Following parameters can be configured for tracking mode **MPP2**:

Value	Range	Description
$U_{OC}$	$0 \dots U_{Nom}$	Voltage of the solar panel when unloaded, taken from the panel specs
$I_{SC}$	$0 \dots I_{Nom}$	Short-circuit current, taken from the panel specs
$\Delta t$	5 ms...60000 ms	Interval for measuring U and I during the process of finding the MPP
$\Delta P$	0 W...0.5 $P_{Nom}$	Tracking/regulation tolerance below the MPP

### 3.11.17.3 Mode MPP3

Also called “**fast track**”, this mode is very similar to mode MPP2, but without the initial step which is used to find the actual MPP, because mode MPP3 would directly jump to the power point defined by user input ( $U_{MPP}$ ,  $P_{MPP}$ ). In case the MPP values of the equipment under test are known, this can save a lot of time in repetitive tests. The rest of the function run is the same as with MPP2 mode. During and after the function, the least acquired MPP values of voltage ( $U_{MPP}$ ), current ( $I_{MPP}$ ) and power ( $P_{MPP}$ ) are shown in the display.

Following parameters can be configured for tracking mode **MPP3**:

Value	Range	Description
$U_{MPP}$	$0 \dots U_{Nom}$	Voltage in the MPP
$I_{SC}$	$0 \dots I_{Nom}$	Short-circuit current, taken from the panel specs
$P_{MPP}$	$0 \dots P_{Nom}$	Power in the MPP
$\Delta t$	5 ms...60000 ms	Interval for measuring U and I during the process of finding the MPP
$\Delta P$	0 W...0.5 $P_{Nom}$	Tracking/regulation tolerance below the MPP

### 3.11.17.4 Mode MPP4

This mode is different to the others, because it does not track automatically. It rather offers the choice to define a user curve by setting up to 100 points of voltage values, then track this curve, measure current and power and return the results in up to 100 sets of acquired data. The curve points can be entered manually or loaded from USB stick. Start and end point can be adjusted as well,  $\Delta t$  defines the time between two points and the function run can be repeated up to 65535 times. Once the function stops at the end or due to manual interrupt, the DC input is switched off and the measured data is made available. After the function, the acquired set of data with the highest actual power will be shown in the display as voltage ( $U_{MPP}$ ), current ( $I_{MPP}$ ) and power ( $P_{MPP}$ ) of the MPP. Going back on the screen with RETURN then allows for data export of the 100 measured results to USB stick.

Following parameters can be configured for tracking mode **MPP4**:

Value	Range	Description
$U_1 \dots U_{100}$	$0 \dots U_{Nom}$	Voltage for the up to 100 user definable curve points
Start	1-100	Start point for the run of x out of 100 subsequent points
End	1-100	End point for the run of x out of 100 subsequent points
$\Delta t$	5...60000 ms	Time before the next point
Rep.	0-65535	Number of repetitions for the run from Start to End

### 3.11.17.5 Load curve data from USB stick for mode MPP4

Alternatively to manual adjustment of the 1-100 available curve points, which can be quite time-consuming, the curve point data (only one voltage value per point) can be loaded from USB stick in form of a CSV file. See section 1.9.6.5 for the naming convention. Contrary to manual adjustment where you can define and use an arbitrary number of points, loading from USB requires the CSV file to always contain the full number of points (100), because it can't define which one is start and end. However, the on-screen setting for **Start** and **End** point remain valid. It means, if you actually want to use all 100 points from your loaded curve, you must set the parameters according.

File format definition:

- The file must be a text file with appendix \*.csv
- The file must contain only one column of voltage values (0... rated voltage)
- The file must exactly 100 values in 100 rows, no gaps
- The decimal separator of broken values must follow the setting “USB file separator format” where selection “US” means dot as decimal separator and selection “Standard” means comma

## ► How to load a curve data file for MPP4

1. While the DC terminal is switched off, enter the **MENU** and the **Function Generator** and access **MPP Tracking**.
2. In the screen switch to tab MPP4. In the lower part a button labelled **Import/Export** will appear. Tap it.
3. In the next screen tap on **LOAD MPP4 voltage values from USB**, have your USB stick ready and follow the instructions.

### 3.11.17.6 Save result data from MPP4 mode to USB stick

After the MPP4 function has run through, the result data can be saved to USB stick. The device will always save 100 data sets consisting of the actual values of voltage, current and power belonging to the points it has run through. There is no extra numbering. In case the settings **Start** and **End** were not 1 and 100, the true result data can later be filtered from the file. Points which were not adjusted are automatically set to 0 V, thus it's very important to carefully adjust start and end point because with a voltage setting of 0 V an electronic load would draw its rated current. That's because in this mode, current and power are always set to max.

Format of the result data file (for naming convention see section 1.9.6.5):

	A	B	C
1	1,01V	20,960A	21,0W
2	2,99V	20,970A	63,0W
3	3,99V	20,970A	84,0W
4	5,99V	20,940A	125,0W
5	7,00V	20,920A	146,0W
6	8,00V	20,930A	168,0W
7	9,00V	20,950A	188,0W
8	9,99V	20,960A	210,0W
9	10,99V	20,970A	231,0W

Legend:

- Column A: actual voltage of points 1-100 (=  $U_{MPP}$ )
- Column B: actual current of points 1-100 (=  $I_{MPP}$ )
- Column C: actual power of points 1-100 (=  $P_{MPP}$ )
- Rows 1-100: result data sets of all possible curve points



*The values in the example table to the left are with physical units. If that's not wanted, they can be turned off in the "General settings" of the device with parameter "USB logging with units (V,A,W)".*

## ► How to save a curve data file for MPP4

1. After the function has run through, it will stop automatically. Tap on the **RETURN** button to go back to the MPP4 configuration screen.
2. Tap on the button labelled **Import/Export**.
3. In the next screen tap on **SAVE MPP4 results to USB**, have your USB stick ready and follow the instructions. You will have the choice to either overwrite any of the displayed files or to create a new one by tapping on **-NEW FILE-**.

### 3.11.18 Remote control of the function generator

The function generator can be remotely controlled, but configuration and control of the functions with individual commands is different from manual operation. The external documentation "Programming Guide ModBus & SCPI" on the included USB stick explains the approach. In general the following items apply:

- The function generator isn't directly controllable via the analog interface; the only impact to the function run can come from pin REM-SB switching the DC terminal off, which will pause the function, so it could continue later with pin REM-SB switching the DC terminal on again and in case the function hasn't been stopped otherwise.
- The function generator is unavailable if R mode (resistance) is activated

## 3.12 Other applications

### 3.12.1 Parallel operation in master-slave (MS)

Multiple devices of same kind and model can be connected in parallel in order to create a system with higher total current and hence higher power. For parallel operation in master-slave mode the units are usually connected with their DC terminals, their Share bus and their master-slave bus, which is a digital bus that makes the system work as one big unit regarding adjusted values, actual values and status.

The Share bus is intended to balance the units dynamically in their voltage on the DC terminal, i.e. in CV mode, especially if the master unit runs a dynamic function. In order for this bus to work correctly, at least the DC minus poles of all units have to be connected, because DC minus is the reference for the Share bus.

Principle view:

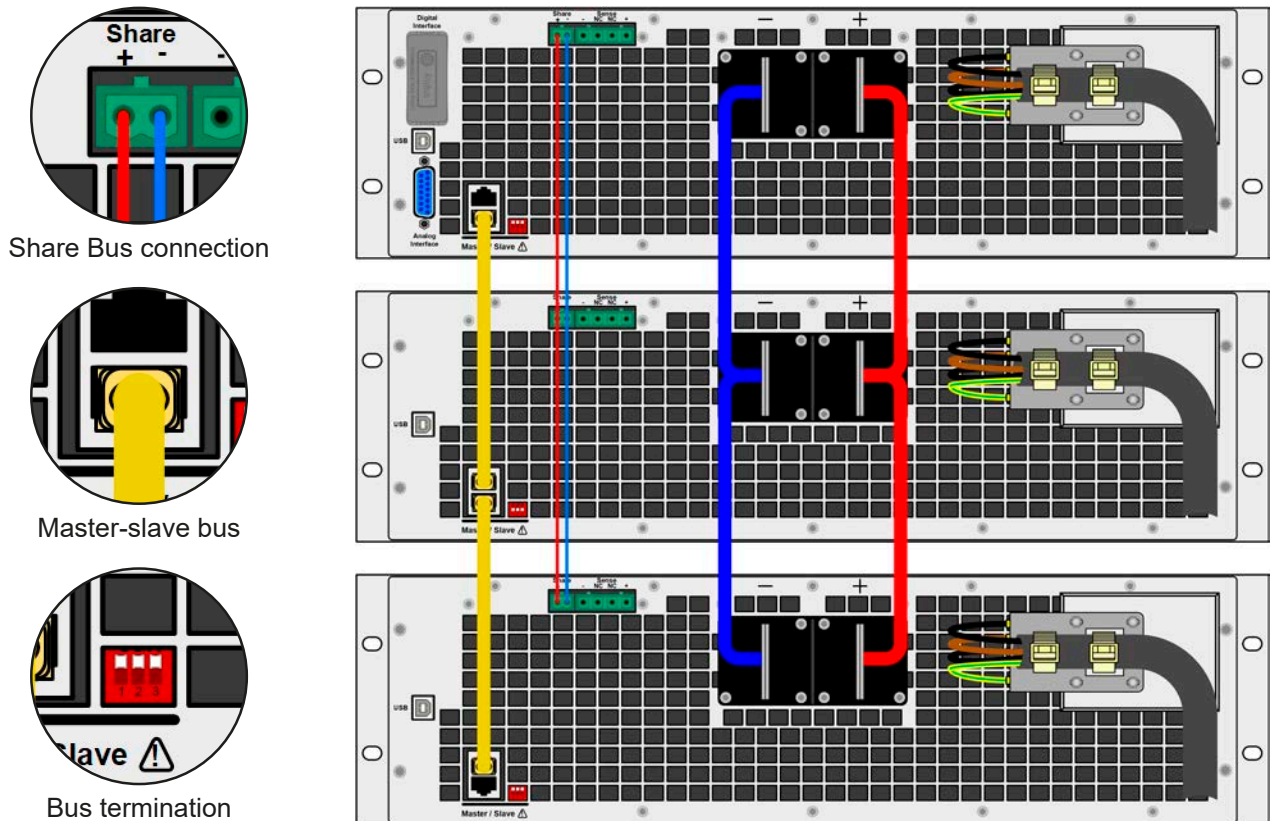

#### 3.12.1.1 Restrictions

Compared to normal operation of a single device, master-slave operation has some *restrictions*:

- The MS system reacts partly different in alarm situations (see below in 3.12.1.6)
- Using the Share bus makes the system react as dynamic as possible, but it's still not as dynamic as single unit operation
- Connection to identical models from other series isn't supported, the master would not initialize them

#### 3.12.1.2 Wiring the DC terminals

The DC terminal of every unit in the parallel operation is connected with correct polarity to the next unit, using cables or copper bars with a cross section according to the total system current and with short as possible length.

#### 3.12.1.3 Wiring the Share bus

The Share bus is wired from unit to unit with an ideally twisted pair of cables with non-critical cross section. We recommend to use 0.5 mm<sup>2</sup> to 1.0 mm<sup>2</sup>.



- The Share bus is poled. Take care for correct polarity of the wiring!
- In order for the Share bus to work correctly it requires at least to connect all DC minus terminals of the devices
- The Share bus connection between multiple PSB 9000 units running in parallel is absolutely required, because it defines the operation mode (source/sink) for the slave units





A max. of 16 units can be connected via Share bus.

### 3.12.1.4 Wiring and set-up of the digital master-slave bus

The master-slave connectors are built-in and can be connected via network cables ( $\geq$ CAT3, patch cable). After this, MS can be configured manually or by remote control. The following applies:

- A maximum of 16 units can be connected via the bus: 1 master and up to 15 slaves.
- Only devices of same kind, i.e. power supply to power supply, and of the same model, such as PSB 9080-120 to PSB 9080-120.
- Units at the end of the bus must be terminated (see below)



The master-slave bus must not be wired using crossover cables!

Later operation of the MS system implies:

- The master unit displays, or makes available to be read by the remote controller, the sum of the actual values of all the units
- The ranges for setting the values, adjustment limits, protections (OVP etc.) and user events (UVD etc.) of the master are adapted to the total number of units. Thus, if e. g. 6 units each with a power of 2.5 kW are connected together to a 15 kW system, then the master can be set in the range 0...15 kW.
- Slaves are no operable as long as being controlled by the master
- Slave units will show the alarm "MSP" in the display or by LED "Error" (where featured) as long as they not have been initialised by the master. The same alarm is signalled after a connection drop to the master unit occurred.
- In case the function generator of the master unit is going to be used, the Share bus must be connected as well

#### ► How to connect the digital master-slave bus

1. Switch off all units that are to be connected and connect them with network cables (CAT3 or better, cables not included). It doesn't matter which of the two master-slave connection sockets (RJ45, backside) is connected to the next unit.
2. Depending on the desired configuration the units can then be connected at the DC side. The two units at the beginning and end of the chain should be terminated, if long connection cables are used. This is achieved using a 3-pole DIP switch which is positioned on the back side of the unit next to the MS connectors.

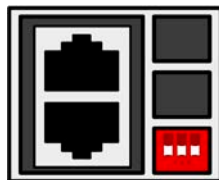





Position: **not terminated** (standard)



Position: **fully terminated**

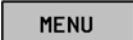



Now the master-slave system has to be configured on each other unit. It's recommended to configure all the slave units first and then the master unit.

#### ► Step 1: Configuring all slave units

1. Enter  then GENERAL SETTINGS and press  until reaching the master-slave settings.
2. Activate the MS mode with touch area . A warning requester will appear which has to be acknowledged with OK, otherwise the change will be reverted.
3. Accept the settings with the touch area  and return to the main page.

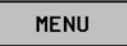
The slave is then configured for master-slave. Repeat the procedure for all other slave units.

## ► Step 2: Configuring the master unit

1. Enter , then GENERAL SETTINGS and press  until reaching the master-slave settings.
2. Specify the unit as master with touch area . A warning requester will appear which has to be acknowledged with OK, otherwise the change will be reverted.
3. Accept the settings with the touch area  and return to the main page.

## ► Step 3: Initializing the master

The master unit and the whole master-slave system must now be initialized, which is done automatically after the master unit has been activated for MS. In the main page, after leaving the setting menus, a pop-up will appear:



Tapping **Initialize** repeats the search for slaves in case the detected number of slaves is less than expected, the system has been reconfigured, not all slave units are already set as **Slave** or the cabling/termination is still not OK. The result window shows the number of slaves, plus the total current, power and resistance of the MS system.

In case there are no slaves found, the master will still initialise the MS system with only itself.



*The initialising process of the master and the master-slave system will, as long as MS mode is still activated, be repeated each time the units are powered. The initialisation can also be repeated manually anytime via the MENU in GENERAL SETTINGS.*

### 3.12.1.5 Operating the master-slave system

After successful configuration and initialization of the master and slave units, they will show their status in the displays. While the master merely shows “Master” in the status area, the slave(s) will continuously show like this, as long they are in remote control by the master:

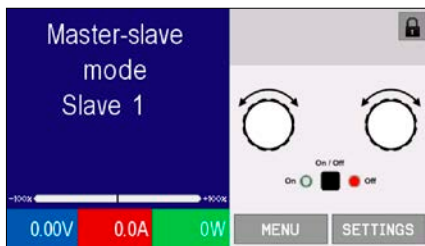

It means, as long as a slave unit is in control by the master, it won't display any set values, but actual values, and it will show the DC terminal status and a possible alarm.

The slaves can no longer be controlled manually or remotely, neither via the analog nor via digital interfaces. They can, if needed, be monitored by reading actual values and status.

The display on the master unit changes after initialization and all set values are reset. The master now displays the set and actual values of the total system. Depending on the number of units, the total current and power will multiply. The following applies:

- The master can be treated like a standalone unit
- The master shares the set values etc. across the slaves and controls them
- The master is remotely controllable via the analog or digital interfaces
- All settings for the set values U, I and P (supervision, limits etc.) should be adapted to the new total values
- All initialised slaves will reset any limits ( $U_{Min}$ ,  $I_{Max}$  etc.), supervision thresholds (OVP, OPP etc.) and event settings (UCD, OVD etc.) to default values, so these don't interfere the control by the master. As soon as these values are modified on the master, they are transferred 1:1 to the slaves. Later, during operation, it might occur that a slave causes an alarm or event rather than the master, due to imbalanced current or slightly faster reaction.



*In order to easily restore all these settings values to what was before activating MS operation, it's recommended to make use of the user profiles (see „3.10. Loading and saving a user profile“)*

- If one or more slaves report an device alarm, it will be displayed on the master and must be acknowledged there so that the slave(s) can continue their operation. Since an alarm causes the DC terminals to be switched off and it can only reinstate automatically after PF or OT alarms, it can be required to switch it on again by the operator or by a remote control software.

- Loss of connection to any slave will result in shutdown of all DC terminals, as a safety measure, and the master will report this situation in the display with a pop-up “Master-slave security mode”. Then the MS system has to be re-initialised, either with or without re-establishing connection to the disconnected unit(s) before.
- All units, even the slaves, can be externally shut down on the DC terminals using the pin REM-SB of the analog interface. This can be used as some kind of emergency off, where usually a contact (maker or breaker) is wired to this pin on all units in parallel.

### 3.12.1.6 Alarms and other problem situations

Master-slave operation, due to the connection of multiple units and their interaction, can cause additional problem situations which do not occur when operating individual units. For such occurrences the following regulations have been defined:

- Generally, if the master loses connection to any slave, it will generate an MSP (master-slave protection) alarm, pop up a message on the screen and switch off its DC terminal. The slaves will fall back to single operation mode, but also switch off their DC terminal. The MSP alarm can be deleted by initialising the master-slave system again. This can be done either in the MSP alarm pop-up screen or in the MENU of the master or via remote control. Alternatively, the alarm is also cleared by deactivating master-slave on the master unit
- If one or more slave units are cut from AC supply (power switch, blackout, supply undervoltage) and come back later, they're not automatically initialised and included again in the MS system. Then the init has to be repeated.
- If the master unit is cut from AC supply (power switch, blackout) and comes back later, the unit will automatically initialise the MS system again, finding and integrating all active slaves. In this case, MS can be restored automatically.
- If multiple units are defined as master the master-slave system can't be initialized

In situations where one or multiple units generate a device alarm like OVP etc. following applies:

- Any alarm of a slave is indicated on the slave's display and on the master's display
- If multiple alarms happen simultaneously, the master only indicates the most recent one. In this case, the particular alarms can be read from the slave units displays or via digital interface by any software.
- All units in the MS system supervise their own values regarding overvoltage, overcurrent and overpower and in case of alarm they report the alarm to the master. In situations where the current is probably not balanced between the units, it can occur that one unit generates an OCP alarm though the global OCP limit of the MS system was not reached. The same can occur with the OPP alarm.

### 3.12.1.7 Important to know



- *In case one or several units of a parallel system are not going to be used and remain switched off, depending on the number of active units and the dynamics of the operation it may become necessary to disconnect the inactive units from the Share bus, because even when not powered the units can have a negative impact on the Share bus due to their impedance.*
- *Slave devices with a display have an extra option in the configuration page for master-slave which can be activated to switch off the back light of the display after some time. This can be helpful, because after initialization of the MS system the slaves' displays are not needed anymore. The feature itself is, however, identical to the option in the HMI settings.*

### 3.12.2 Series connection



Besides being able to work as a power supply, the device is also an electronic load. Series connection isn't a permissible operating method for electronic loads and must not be installed or operated under any circumstances!

Explanation of this restriction:

Series operation of electronic load absolutely requires a balanced voltage distribution over all included units, so no unit has to “see” an overvoltage. This can only be achieved by additional controller hardware which balances the devices. Such a feature is not included and also not available as option.

Unbalanced voltage and thus possible overvoltage can occur anytime when the units regulate their internal resistance while being slightly different in their reaction time. This especially is the case when switching the DC input s of the units on at almost the same time, after which the internal regulators don't start to drive the load's resistance from high down to low all in the same moment.

Additionally, for protection of the units against overvoltage and subsequent damage, it would require to install a voltage supervision hardware on every unit, plus a mechanism that could immediately cut the external voltage, such as a contactor.

## 3.12.3 Operation as battery charger (source mode)

A power supply (here: PSB 9000 in source mode) can be used as a battery charger, but with some restrictions, because it misses a battery supervision and a physical separation from the load in form of a relay or contactor, which is sometimes featured with real battery chargers as a protection.

Following has to be considered:

- No false polarity protection inside! Connecting a battery with false polarity will damage the power supply severely, even if it isn't powered.

## 4. Service and maintenance

### 4.1 Maintenance / cleaning

The device needs no recurring maintenance. Cleaning may be needed for the internal fans, the frequency of cleanse is depending on the ambient conditions. The fans serve to cool the components which are heated by the inherent power loss. Heavily dirt filled fans can lead to insufficient airflow and therefore the DC terminal would switch off too early due to overheating or possibly lead to defects.

In case there is requirement for such a maintenance, please contact us.

### 4.2 Fault finding / diagnosis / repair

If the equipment suddenly performs in an unexpected way, which indicates a fault, or it has an obvious defect, this can't and must not be repaired by the user. Contact the supplier in case of suspicion and elicit the steps to be taken.

It will then usually be necessary to return the device to the supplier (with or without guarantee). If a return for checking or repair is to be carried out, ensure that:

- the supplier has been contacted and it's clarified how and where the equipment should be sent.
- the device is in fully assembled state and in suitable transport packaging, ideally the original packaging.
- optional extras such as an interface module is included if this is in any way connected to the problem.
- a fault description in as much detail as possible is attached.
- if shipping destination is abroad, the necessary customs papers are attached.

#### 4.2.1 Firmware updates



Firmware updates should only be installed when they can eliminate existing bugs in the firmware in the device or contain new features.

The firmware of the control panel (HMI), of the communication unit (KE) and the digital controller (DR), if necessary, is updated via the rear side USB port. For this the software EA Power Control is needed which is included with the device or available as download from our website together with the firmware update, or upon request.

However, be advised not to install updates promptly. Every update includes the risk of an inoperable device or system. We recommend to install updates only if...

- an imminent problem with your device can directly be solved, especially if we suggested to install an update during a support case
- a new feature has been added which you definitely want to use. In this case, the full responsibility is transferred to you.

Following also applies in connection with firmware updates:

- Simple changes in firmwares can have crucial effects on the application the devices are use in. We thus recommend to study the list of changes in the firmware history very thoroughly.
- Newly implemented features may require an updated documentation (user manual and/or programming guide, as well as LabView VIs), which is often delivered only later, sometimes significantly later
-

## 4.3 Calibration

### 4.3.1 Preface

The devices of series PSB 9000 don't have a built-in feature to re-adjust the most important DC terminal related values, but they can still be readjusted using the software EA Power Control. The required calibration app is included in the free of charge base version of this software. In order to use the feature it may be necessary to install an update of this software.

Re-adjustment is intended to compensate small deviations of the output related values of voltage and current in a range of up to 1% or 2% of the rated value. There are several reasons which could make it necessary to re-adjust a unit: component aging, component deterioration, extreme ambient conditions, high frequent use.

In order to determine if a value is out of tolerance, the parameter must first be verified with measurement tools of high accuracy and with at least half the error of the PSB device. Only then a comparison between values displayed on the PSB device and the true value on the DC terminal is possible.

For example, if you want to verify and possibly readjust the output current of model PSB 9080-120 which has 120 A maximum current, stated with a max. error of 0.2%, you can only do that by using a high current shunt or current transducer with max. 0.1% error or less. Also, when measuring such high currents, it's recommended to keep the process short, in order to avoid the shunt heating up too much. It's furthermore recommended to use a shunt with at least 25% reserve.

When measuring the current with a shunt, the measurement error of the multimeter on the shunt adds to the error of the shunt and the sum of both must not exceed the max. error of the device under calibration.

### 4.3.2 Preparation

For a successful calibration and readjustment, a few tools and certain ambient conditions are required:

- A measurement device (multimeter) for voltage, with a max. error of half the PSB's voltage error. That measurement device can also be used to measure the shunt voltage when readjusting the current
- If the current is also going to be calibrated: a suitable DC current shunt or transducer, ideally specified for at least 1.25 times the max. current rating of the PSB and with a max. error that is half or less than the max. current error of the PSB device to calibrate
- Normal ambient temperature of approx. 20-25°C
- One or two adjustable loads, preferably electronic ones, which are capable of consuming at least 102% of the max. voltage and current of the PSB device and which are calibrated and precise
- An adjustable source which is capable of supplying at least 102% of the max. voltage and current of the PSB device and which is calibrated and precise

Before you can start calibrating, a few measures have to be taken:

- Let the PSB device warm up for at least 10 minutes under 50% load, in connection with the voltage / current source
- In case the remote sensing input is going to be calibrated, prepare a cable for the remote sensing connector to the DC terminal, but leave it yet unconnected
- Abort any form of remote control, deactivate master-slave mode, deactivate resistance mode
- Install the shunt or transducer between the PSB device and the load/source and make sure the shunt/transducer is cooled somehow
- Connect external measurement devices to the DC terminal and/or to the shunt/transducer, depending on whether the voltage is going to be calibrated first or the current

### 4.3.3 Calibration procedure

The re-adjustment is done in the graphical user interface of EA Power Control version 2.15 or newer. The software will guide through the process with instructions, as far as possible. The user manual of the software holds additional information.

## 5. Contact and support

### 5.1 Repairs

Repairs, if not otherwise arranged between supplier and customer, will be carried out by the manufacturer. For this the device must generally be returned to the manufacturer. No RMA number is needed. It's sufficient to package the equipment adequately and send it, together with a detailed description of the fault and, if still under guarantee, a copy of the invoice, to the following address.

### 5.2 Contact options

Questions or problems with operation of the device, use of optional components, with the documentation or software, can be addressed to technical support either by telephone or e-Mail.

Address	e-Mail	Telephone
EA Elektro-Automatik GmbH Helmholtzstr. 31-37 41747 Viersen Germany	Technical support: support@elektroautomatik.de  All other issues: ea1974@elektroautomatik.de	Switchboard: +49 2162 / 37850 Support: +49 2162 / 378566





**Elektro-Automatik**

**EA Elektro-Automatik GmbH & Co. KG**  
Development - Production - Sales

Helmholtzstraße 31-37  
**41747 Viersen**  
**Germany**

Fon: +49 2162 / 37 85-0  
Mail: [ea1974@elektroautomatik.de](mailto:ea1974@elektroautomatik.de)  
Web: [www.elektroautomatik.de](http://www.elektroautomatik.de)