



Operating Guide

PSI 9000 WR 3U Slave

DC High Efficiency Power Supply

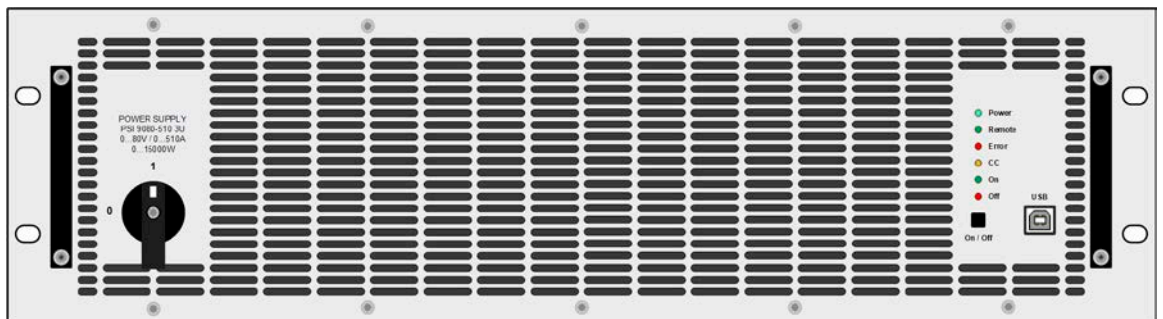

TABLE OF CONTENTS

1 GENERAL

1.1	About this document	4
1.1.1	Retention and use	4
1.1.2	Copyright	4
1.1.3	Validity	4
1.1.4	Symbols and warnings	4
1.2	Warranty	4
1.3	Limitation of liability	4
1.4	Disposal of equipment	5
1.5	Product key	5
1.6	Intended usage	5
1.7	Safety	6
1.7.1	Safety notices	6
1.7.2	Responsibility of the user	7
1.7.3	Responsibility of the operator	7
1.7.4	User requirements	7
1.7.5	Alarm signals	8
1.8	Technical Data	8
1.8.1	Approved operating conditions	8
1.8.2	General technical data	8
1.8.3	Specific technical data	9
1.8.4	Views	13
1.9	Construction and function	17
1.9.1	General description	17
1.9.2	Block diagram	17
1.9.3	Scope of delivery	17
1.9.4	The control panel (HMI)	18
1.9.5	USB port type B (rear side)	18
1.9.6	“Share” connector	19
1.9.7	“Sense” connector (remote sensing)	19
1.9.8	Master-Slave bus	19

2 INSTALLATION & COMMISSIONING

2.1	Transport and storage	20
2.1.1	Transport	20
2.1.2	Packaging	20
2.1.3	Storage	20
2.2	Unpacking and visual check	20
2.3	Installation	20
2.3.1	Safety procedures before installation and use	20
2.3.2	Preparation	20
2.3.3	Installing the device	22
2.3.4	Connection to AC supply	23
2.3.5	Connection to DC loads	25
2.3.6	Grounding of the DC output	26
2.3.7	Connection of remote sense	26
2.3.8	Connecting the “Share” bus	27
2.3.9	Connecting the USB port	27
2.3.10	Initial commission	28
2.3.11	Commission after a firmware update or a long period of non-use	28

3 OPERATION AND APPLICATION

3.1	Personal safety	29
3.2	Operating modes	29
3.2.1	Voltage regulation / Constant voltage	29
3.2.2	Current regulation / constant current / current limiting	30
3.2.3	Power regulation / constant power / power limiting	30
3.2.4	Internal resistance regulation	30
3.3	Alarm conditions	31
3.3.1	Power Fail	31
3.3.2	Overtemperature	31
3.3.3	Overvoltage protection	31
3.3.4	Overcurrent protection	31
3.3.5	Overpower protection	31
3.3.6	Safety OVP	32
3.4	Manual operation	33
3.4.1	Powering the device	33
3.4.2	Switching the device off	33
3.4.3	Switching the DC output on or off	33
3.5	Remote control	34
3.5.1	General	34
3.5.2	Remote control via the rear USB	34
3.5.3	Remote control via the front USB	34
3.5.4	Programming	35
3.6	Alarms and monitoring	36
3.6.1	Definition of terms	36
3.6.2	Device alarm and event handling	36
3.7	Other applications	38
3.7.1	Parallel operation in master-slave (MS)	38
3.7.2	Series connection	40
3.7.3	Two quadrants operation (2QO)	41

4 SERVICE AND MAINTENANCE

4.1	Maintenance / cleaning	42
4.2	Fault finding / diagnosis / repair	42
4.2.1	Firmware update	42

5 CONTACT AND SUPPORT

5.1	General	43
5.2	Contact options	43

1. General

1.1 About this document

1.1.1 Retention and use

This document is to be kept in the vicinity of the equipment for future reference and explanation of the operation of the device. This document is to be delivered and kept with the equipment in case of change of location and/or user.

1.1.2 Copyright

Reprinting, copying, also partially, usage for other purposes as foreseen of this manual are forbidden and breach may lead to legal process.



1.1.3 Validity

This manual is valid for the following equipment:

Model	Article nr.
PSI 9080-510 WR 3U Slave	06280364
PSI 9200-210 WR 3U Slave	06280365
PSI 9360-120 WR 3U Slave	06280366
PSI 9500-90 WR 3U Slave	06280367
PSI 9750-60 WR 3U Slave	06280368
PSI 91000-40 WR 3U Slave	06280370
PSI 91500-30 WR 3U Slave	06280369

1.1.4 Symbols and warnings

Warning and safety notices as well as general notices in this document are shown in a box with a symbol as follows:

	Symbol for a life threatening danger
	Symbol for general safety notices (instructions and damage protection bans) or important information for operation
	<i>Symbol for general notices</i>

1.2 Warranty

EA Elektro-Automatik guarantees the functional competence of the applied technology and the stated performance parameters. The warranty period begins with the delivery of free from defects equipment.

Terms of guarantee are included in the general terms and conditions (TOS) of EA Elektro-Automatik.

1.3 Limitation of liability

All statements and instructions in this manual are based on current norms and regulations, up-to-date technology and our long term knowledge and experience. The manufacturer accepts no liability for losses due to:

- Usage for purposes other than designed
- Use by untrained personnel
- Rebuilding by the customer
- Technical changes
- Use of not authorized spare parts

The actual delivered device(s) may differ from the explanations and diagrams given here due to latest technical changes or due to customized models with the inclusion of additionally ordered options.

1.4 Disposal of equipment

A piece of equipment which is intended for disposal must, according to European laws and regulations (ElektroG, WEEE) be returned to the manufacturer for scrapping, unless the person operating the piece of equipment or another, delegated person is conducting the disposal. Our equipment falls under these regulations and is accordingly marked with the following symbol:



1.5 Product key

Decoding of the product description on the label, using an example:

PSI 9080 - 510 WR 3U Slave

	Construction:
	Slave = Ancillary unit for master-slave operation
	3U = 3 rack units of height
	Version:
	WR = Wide range (extended AC input voltage range)
	Maximum current of the device in Ampere
	Maximum voltage of the device in Volt
	Series: 9 = Series 9000
	Type identification:
	PSI = Power Supply Intelligent, programmable

1.6 Intended usage

The equipment is intended to be used, if a power supply or battery charger, only as a variable voltage and current source, or, if an electronic load, only as a variable current sink.

Typical application for a power supply is DC supply to any relevant user, for a battery charger the charging of various battery types and for electronic loads the replacement of an ohmic resistor by an adjustable DC current sink in order to load relevant voltage and current sources of any type.



- Claims of any sort due to damage caused by non-intended usage will not be accepted.
- All damage caused by non-intended usage is solely the responsibility of the operator.

1.7 Safety**1.7.1 Safety notices****Mortal danger - Hazardous voltage**

- **Electrical equipment operation means that some parts can be under dangerous voltage. Therefore all parts under voltage must be covered! This basically applies to all models, though 40 V models according to SELV can't generate hazardous DC voltage.**
- **All work on connections must be carried out under zero voltage (output not connected to load) and may only be performed by qualified and informed persons. Improper actions can cause fatal injury as well as serious material damage.**
- **Never touch cables or connectors directly after unplugging from mains supply as the danger of electric shock remains!**
- **Never touch the contacts on DC output terminal directly after switching off the DC output, because there still can dangerous voltage present, sinking more or less slowly depending on the load! There also can be dangerous potential between negative DC output to PE or positive DC output to PE due to charged X capacitors, which don't discharge at all or only very slowly.**
- **Always follow 5 safety rules when working with electric devices:**
 - **Disconnect completely**
 - **Secure against reconnection**
 - **Verify that the system is dead**
 - **Carry out earthing and short-circuiting**
 - **Provide protection from adjacent live parts**



- The equipment must only be used as intended
- The equipment is only approved for use within the connection limits stated on the product label.
- Do not insert any object, particularly metallic, through the ventilator slots
- Avoid any use of liquids near the equipment. Protect the device from wet, damp and condensation.
- For power supplies and battery chargers: do not connect users, particularly low resistance, to devices under power; sparking may occur which can cause burns as well as damage to the equipment and to the user.
- For electronic loads: do not connect power sources to equipment under power, sparking may occur which can cause burns as well as damage to the equipment and to the source.
- ESD regulations must be applied when plugging interface cards or modules into the relative slot
- Interface cards or modules may only be attached or removed after the device is switched off. It is not necessary to open the device.
- Do not connect external power sources with reversed polarity to DC input or outputs! The equipment will be damaged.
- For power supply devices: avoid where possible connecting external power sources to the DC output, and never those that can generate a higher voltage than the nominal voltage of the device.
- For electronic loads: do not connect a power source to the DC input which can generate a voltage more than 120% of the nominal input voltage of the load. The equipment is not protected against over voltage and may be irreparably damaged.
- Never insert a network cable which is connected to Ethernet or its components into the master-slave socket on the rear side of the device!
- Always configure the various protecting features against overcurrent, overpower etc. for sensitive loads to what the target application requires!

1.7.2 Responsibility of the user

The equipment is in industrial operation. Therefore the operators are governed by the legal safety regulations. Alongside the warning and safety notices in this manual the relevant safety, accident prevention and environmental regulations must also be applied. In particular the users of the equipment:

- must be informed of the relevant job safety requirements
- must work to the defined responsibilities for operation, maintenance and cleaning of the equipment
- before starting work must have read and understood the operating manual
- must use the designated and recommended safety equipment.

Furthermore, anyone working with the equipment is responsible for ensuring that the device is at all times technically fit for use.

1.7.3 Responsibility of the operator

Operator is any natural or legal person who uses the equipment or delegates the usage to a third party, and is responsible during its usage for the safety of the user, other personnel or third parties.

The equipment is in industrial operation. Therefore the operators are governed by the legal safety regulations. Alongside the warning and safety notices in this manual the relevant safety, accident prevention and environmental regulations must also be applied. In particular the operator has to

- be acquainted with the relevant job safety requirements
- identify other possible dangers arising from the specific usage conditions at the work station via a risk assessment
- introduce the necessary steps in the operating procedures for the local conditions
- regularly control that the operating procedures are current
- update the operating procedures where necessary to reflect changes in regulation, standards or operating conditions.
- define clearly and unambiguously the responsibilities for operation, maintenance and cleaning of the equipment.
- ensure that all employees who use the equipment have read and understood the manual. Furthermore the users are to be regularly schooled in working with the equipment and the possible dangers.
- provide all personnel who work with the equipment with the designated and recommended safety equipment

Furthermore, the operator is responsible for ensuring that the device is at all times technically fit for use.

1.7.4 User requirements

Any activity with equipment of this type may only be performed by persons who are able to work correctly and reliably and satisfy the requirements of the job.

- Persons whose reaction capability is negatively influenced by e.g. drugs, alcohol or medication may not operate the equipment.
- Age or job related regulations valid at the operating site must always be applied.



Danger for unqualified users

Improper operation can cause person or object damage. Only persons who have the necessary training, knowledge and experience may use the equipment.

Delegated persons are those who have been properly and demonstrably instructed in their tasks and the attendant dangers.

Qualified persons are those who are able through training, knowledge and experience as well as knowledge of the specific details to carry out all the required tasks, identify dangers and avoid personal and other risks.

All work on electrical equipment may only be performed by qualified electricians.

1.7.5 Alarm signals

Alarm conditions, not danger situations, are signaled on the front of this slave device in form of a red LED “**Error**” (also see section 1.8.4.). Because the models of this series are designed to run as slave units in a master-slave system, the master unit will indicate alarms in its own available ways. Refer to the manual of series PSI 9000 WR 3U for more information about this matter.

The LED collects all of the below listed alarm situations. If there is supervision of the slave units being used, alarms can be decoded by querying a status from the device via any of the two USB ports.

Global meaning of alarm situation as indicated by LED “Error”:

Signal OT (OverTemperature)	<ul style="list-style-type: none"> • Overheating of the device • DC output will be switched off • Non-critical
Signal OVP (OverVoltage)	<ul style="list-style-type: none"> • Overvoltage shutdown of the DC output due to high voltage entering the device or generated by the device itself due to a defect • Critical! The device and/or the load could be damaged
Signal OCP (OverCurrent)	<ul style="list-style-type: none"> • Shutdown of the DC output due to excess of the preset limit • Non-critical, protects the load from excessive current consumption
Signal OPP (OverPower)	<ul style="list-style-type: none"> • Shutdown of the DC output due to excess of the preset limit • Non-critical, protects the load from excessive power consumption
Signal PF (Power Fail)	<ul style="list-style-type: none"> • DC output shutdown due to AC undervoltage or defect in the AC input • Critical on overvoltage! AC input circuit could be damaged

1.8 Technical Data

1.8.1 Approved operating conditions

- Use only inside dry buildings
- Ambient temperature 0-50 °C (32-122 °F)
- Operational altitude: max. 2000 m (1.242 mi) above sea level
- Max 80% relative humidity, not condensing

1.8.2 General technical data

Indication: 6x color LEDs

Controls: 1 pushbutton

The nominal values for the device determine the maximum adjustable ranges.

1.8.3 Specific technical data

15 kW	Model WR Slave		
	PSI 9080-510	PSI 9200-210	PSI 9360-120
AC Input			
Voltage (L-L)	342...528 V AC, 45 - 65 Hz		
Connection	3ph (L1+L2+L3), PE		
Fusing (internal)	6x T16 A		
Leak current	< 3.5 mA		
Power factor	> 0.99		
DC Output			
Max. output voltage U_{Max}	80 V	200 V	360 V
Max. output current I_{Max}	510 A	210 A	120 A
Max. output power P_{Max}	15 kW	15 kW	15 kW
Oversvoltage protection range	0...88 V	0...220 V	0...396 V
Overcurrent protection range	0...561 A	0...231 A	0...132 A
Overpower protection range	0...16,5 kW	0...16,5 kW	0...16,5 kW
Temperature coefficient for set values Δ/K	Voltage / current: 100 ppm		
Output capacitance (approx.)	25380 μ F	7560 μ F	1200 μ F
Voltage regulation			
Adjustment range	0...81.6 V	0...204 V	0...367.2 V
Accuracy ⁽¹⁾ (at 23 \pm 5 $^{\circ}$ C / 73 \pm 9 $^{\circ}$ F)	< 0.1% U_{Max}	< 0.1% U_{Max}	< 0.1% U_{Max}
Line regulation at $\pm 10\%$ ΔU_{AC}	< 0.02% U_{Max}	< 0.02% U_{Max}	< 0.02% U_{Max}
Load regulation at 0...100% load	< 0.05% U_{Max}	< 0.05% U_{Max}	< 0.05% U_{Max}
Rise time 10...90% ΔU	Max. 30 ms	Max. 30 ms	Max. 30 ms
Transient time after load step	< 1.5 ms	< 1.5 ms	< 1.5 ms
Ripple ⁽²⁾	< 320 mV _{PP} < 25 mV _{RMS}	< 300 mV _{PP} < 40 mV _{RMS}	< 550 mV _{PP} < 65 mV _{RMS}
Remote sensing compensation	Max. 5% U_{Max}	Max. 5% U_{Max}	Max. 5% U_{Max}
Fall time at no load after switching DC off	Down from 100% to <60 V: less than 10 s		
Current regulation			
Adjustment range	0...520.2 A	0...214.2 A	0...122.4 A
Accuracy ⁽¹⁾ (at 23 \pm 5 $^{\circ}$ C / 73 \pm 9 $^{\circ}$ F)	< 0.2% I_{Max}	< 0.2% I_{Max}	< 0.2% I_{Max}
Line regulation at $\pm 10\%$ ΔU_{AC}	< 0.05% I_{Max}	< 0.05% I_{Max}	< 0.05% I_{Max}
Load regulation at 0...100% ΔU_{OUT}	< 0.15% I_{Max}	< 0.15% I_{Max}	< 0.15% I_{Max}
Ripple ⁽²⁾	< 240 mA _{RMS}	< 66 mA _{RMS}	< 16 mA _{RMS}
Power regulation			
Adjustment range	0...15.3 kW	0...15.3 kW	0...15.3 kW
Accuracy ⁽¹⁾ (at 23 \pm 5 $^{\circ}$ C / 73 \pm 9 $^{\circ}$ F)	< 1.2% P_{Max}	< 1% P_{Max}	< 1.2% P_{Max}
Line regulation at $\pm 10\%$ ΔU_{AC}	< 0.05% P_{Max}	< 0.05% P_{Max}	< 0.05% P_{Max}
Load reg. at 10-90% ΔU_{OUT} * ΔI_{OUT}	< 0.75% P_{Max}	< 0.75% P_{Max}	< 0.75% P_{Max}
Efficiency ⁽³⁾	\approx 93%	\approx 95%	\approx 94%
Internal resistance regulation			
Adjustment range	0...5 Ω	0...28 Ω	0...90 Ω
Accuracy ⁽¹⁾	$\leq 1\%$ of max. resistance \pm 0.3% of maximum current		

(1 Related to the nominal values, the accuracy defines the maximum deviation between an adjusted values and the true (actual) value.

Example: a 80 V model has min. 0.1% voltage accuracy, that is 80 mV. When adjusting the voltage to 5 V, the actual value is allowed to differ max. 80 mV, which means it might be between 4.92 V and 5.08 V.

(2 RMS value: LF 0...300 kHz, PP value: HF 0...20MHz

(3 Typical value at 100% output voltage and 100% power

PSI 9000 WR 3U Slave Series

15 kW	Model WR Slave		
	PSI 9080-510	PSI 9200-210	PSI 9360-120
Insulation	Allowed float (potential shift) on the DC output:		
Negative terminal to PE	Max. ± 400 V DC	± 725 V DC	± 725 V DC
Positive terminal to PE	Max. ± 400 V DC	± 1000 V DC	± 1000 V DC
AC input <-> PE	2.5 kV DC		
AC input <-> DC output	2.5 kV DC		
Miscellaneous			
Cooling	Temperature controlled fans, front inlet, rear exhaust		
Ambient temperature	0...50 °C (32...133 °F)		
Storage temperature	-20...70 °C (-4...158 °F)		
Humidity	< 80%, not condensing		
Standards	EN 61010-1:2007-11, EN 61000-6-2:2016-05, EN 61000-6-3:2011-09 Class B		
Overvoltage category	2		
Protection class	1		
Pollution degree	2		
Operational altitude	< 2000 m (1.242 mi)		
Digital interfaces			
Featured	1x USB (front side) for quick value setup 1x USB (rear side) for communication and service		
Galvanic isolation from device	Max. 725 V DC		
Terminals			
Rear side	Share Bus, DC output, AC input, remote sensing, USB, master-slave bus		
Front side	USB		
Dimensions			
Enclosure (WxHxD)	19" x 3U x 670 mm (26.4")		
Total (WxHxD)	483 x 133 x 775 mm (19" x 5.2" x 30.5")		
Weight	≈ 32 kg (70.5 lb)	≈ 32 kg (70.5 lb)	≈ 32 kg (70.5 lb)
Article number	06280364	06280365	06280366

PSI 9000 WR 3U Slave Series

15 kW	Model WR Slave			
	PSI 9500-90	PSI 9750-60	PSI 91000-40	PSI 91500-30
AC Input				
Voltage (L-L)	342...528 V AC, 45 - 65 Hz			
Connection	3ph (L1+L2+L3), PE			
Fusing (internal)	6x T16 A			
Leak current	< 3.5 mA			
Power factor	> 0.99			
DC Output				
Max. output voltage U_{Max}	500 V	750 V	1000 V	1500 V
Max. output current I_{Max}	90 A	60 A	40 A	30 A
Max. output power P_{Max}	15 kW	15 kW	15 kW	15 kW
Overvoltage protection range	0...550 V	0...825 V	0...1100 V	0...1650 V
Overcurrent protection range	0...99 A	0...66 A	0...44 A	0...33 A
Overpower protection range	0...16.5 kW	0...16.5 kW	0...16.5 kW	0...16.5 kW
Temperature coefficient for set values Δ/K	Voltage / current: 100 ppm			
Output capacitance (approx.)	760 μ F	310 μ F	133 μ F	84 μ F
Voltage regulation				
Adjustment range	0...510 V	0...765 V	0...1020 V	0...1530 V
Accuracy ⁽¹⁾ (at 23 \pm 5 $^{\circ}$ C / 73 \pm 9 $^{\circ}$ F)	< 0.1% U_{Max}	< 0.1% U_{Max}	< 0.1% U_{Max}	< 0.1% U_{Max}
Line regulation at \pm 10% ΔU_{AC}	< 0.02% U_{Max}	< 0.02% U_{Max}	< 0.02% U_{Max}	< 0.02% U_{Max}
Load regulation at 0...100% load	< 0.05% U_{Max}	< 0.05% U_{Max}	< 0.05% U_{Max}	< 0.05% U_{Max}
Rise time 10...90% ΔU	Max. 30 ms	Max. 30 ms	Max. 30 ms	Max. 30 ms
Transient time after load step	< 1.5 ms	< 1.5 ms	< 1.5 ms	< 1.5 ms
Ripple ⁽²⁾	< 350 mV _{PP} < 70 mV _{RMS}	< 800 mV _{PP} < 200 mV _{RMS}	< 2000 mV _{PP} < 300 mV _{RMS}	< 2400 mV _{PP} < 400 mV _{RMS}
Remote sensing compensation	Max. 5% U_{Max}	Max. 5% U_{Max}	Max. 5% U_{Max}	Max. 5% U_{Max}
Fall time at no load after switching DC off	Down from 100% to <60 V: less than 10 s			
Current regulation				
Adjustment range	0...91.8 A	0...61.2 A	0...40.8 A	0...30.6 A
Accuracy ⁽¹⁾ (at 23 \pm 5 $^{\circ}$ C / 73 \pm 9 $^{\circ}$ F)	< 0.2% I_{Max}	< 0.2% I_{Max}	< 0.2% I_{Max}	< 0.2% I_{Max}
Line regulation at \pm 10% ΔU_{AC}	< 0.05% I_{Max}	< 0.05% I_{Max}	< 0.05% I_{Max}	< 0.05% I_{Max}
Load regulation at 0...100% ΔU_{OUT}	< 0.15% I_{Max}	< 0.15% I_{Max}	< 0.15% I_{Max}	< 0.15% I_{Max}
Ripple ⁽²⁾	< 48 mA _{RMS}	< 48 mA _{RMS}	< 10 mA _{RMS}	< 26 mA _{RMS}
Power regulation				
Adjustment range	0...15.3 kW	0...15.3 kW	0...15.3 kW	0...15.3 kW
Accuracy ⁽¹⁾ (at 23 \pm 5 $^{\circ}$ C / 73 \pm 9 $^{\circ}$ F)	< 1.2% P_{Max}	< 1.2% P_{Max}	< 1.2% P_{Max}	< 1.2% P_{Max}
Line regulation at \pm 10% ΔU_{AC}	< 0.05% P_{Max}	< 0.05% P_{Max}	< 0.05% P_{Max}	< 0.05% P_{Max}
Load reg. at 10-90% ΔU_{OUT} * ΔI_{OUT}	< 0.75% P_{Max}	< 0.75% P_{Max}	< 0.75% P_{Max}	< 0.75% P_{Max}
Efficiency ⁽³⁾	\approx 95%	\approx 94%	\approx 94%	\approx 95%
Internal resistance regulation				
Adjustment range	0...166 Ω	0...375 Ω	0...1300 Ω	0...1500 Ω
Accuracy ⁽¹⁾	\leq 1% of max. resistance \pm 0.3% of maximum current			

(1 Related to the nominal values, the accuracy defines the maximum deviation between an adjusted values and the true (actual) value.

Example: a 80 V model has min. 0.1% voltage accuracy, that is 80 mV. When adjusting the voltage to 5 V, the actual value is allowed to differ max. 80 mV, which means it might be between 4.92 V and 5.08 V.

(2 RMS value: LF 0...300 kHz, PP value: HF 0...20MHz

(3 Typical value at 100% output voltage and 100% power

PSI 9000 WR 3U Slave Series

15 kW	Model WR Slave			
	PSI 9500-90	PSI 9750-60	PSI 91000-40	PSI 91500-30
Insulation	Allowed float (potential shift) on the DC output:			
Negative terminal to PE	Max. ±1500 V DC	±1500 V DC	±1500 V DC	±1500 V DC
Positive terminal to PE	Max. ±1800 V DC	±1800 V DC	±1800 V DC	±1800 V DC
AC input <-> PE	2.5 kV DC			
AC input <-> DC output	2.5 kV DC			
Miscellaneous				
Cooling	Temperature controlled fans, front inlet, rear exhaust			
Ambient temperature	0...50 °C (32...133 °F)			
Storage temperature	-20...70 °C (-4...158 °F)			
Humidity	< 80%, not condensing			
Standards	EN 61010-1:2007-11, EN 61000-6-2:2016-05, EN 61000-6-3:2011-09 Class B			
Overvoltage category	2			
Protection class	1			
Pollution degree	2			
Operational altitude	< 2000 m (1.242 mi)			
Digital interfaces				
Featured	1x USB (front side) for quick value setup 1x USB (rear side) for communication and service			
Galvanic isolation from device	Max. 1500 V DC			
Terminals				
Rear side	Share Bus, DC output, AC input, remote sensing, USB, master-slave bus			
Front side	USB			
Dimensions				
Enclosure (WxHxD)	19" x 3U x 670 mm (26.4")			
Total (WxHxD)	483 x 133 x 775 mm (19" x 5.2" x 30.5")			
Weight	≈ 32 kg (70.5 lb)	≈ 32 kg (70.5 lb)	≈ 32 kg (70.5 lb)	≈ 32 kg (70.5 lb)
Article number	06280367	06280368	06280370	06280369

1.8.4 Views

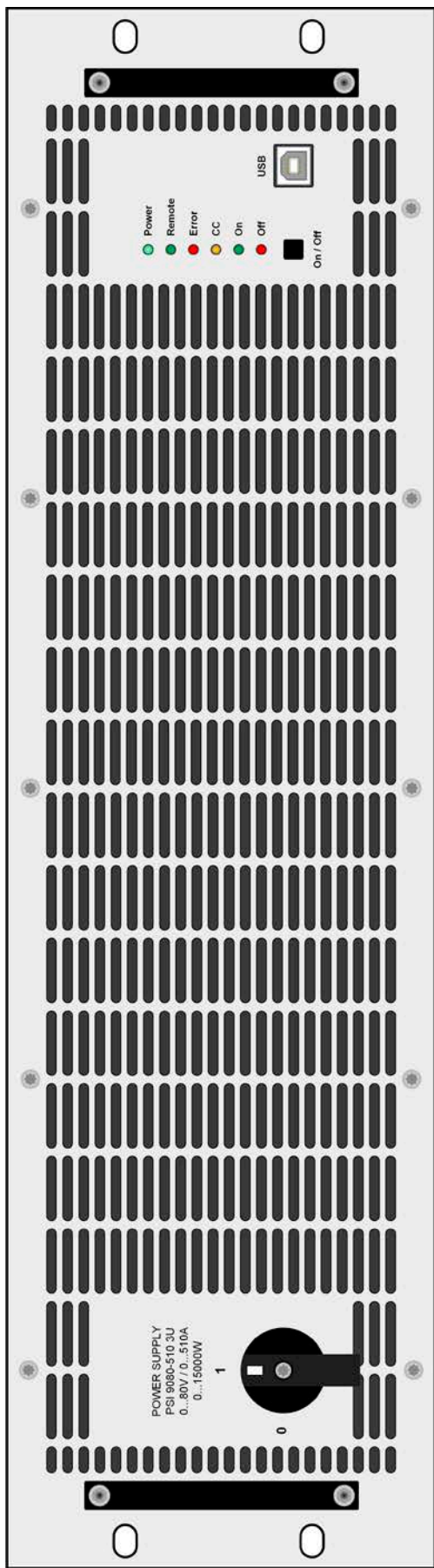

Figure 1 - Front view

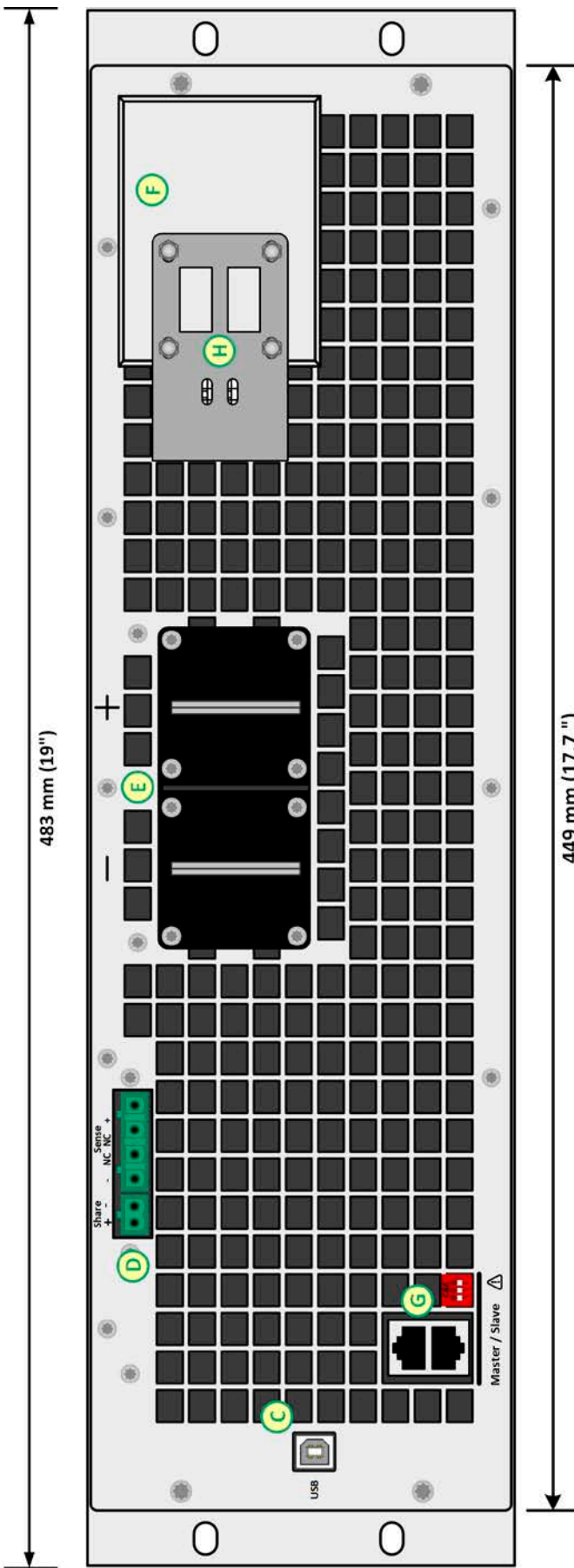

Figure 2 - Rear view

- A - Power switch
- B - Control panel
- C - Rear USB port
- D - Share Bus and remote sensing connection
- E - DC output
- F - AC input connection
- G - Master-slave ports
- H - Plug fixture & strain relief

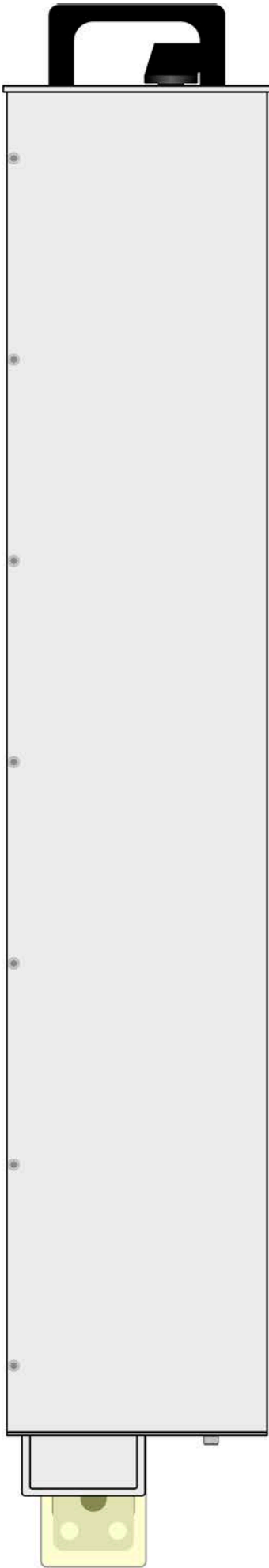

Figure 3 - Side view (right)

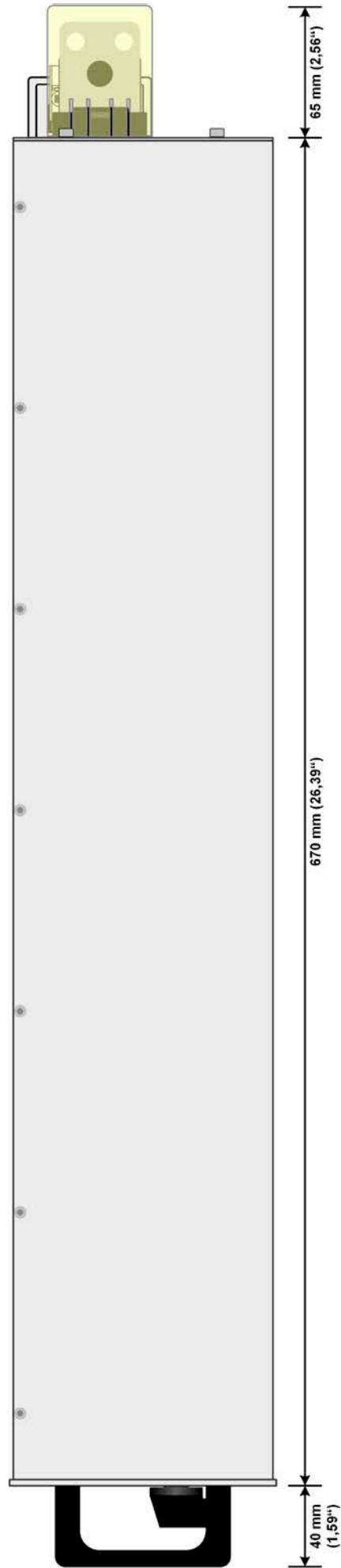

Figure 4 - Side view (left)

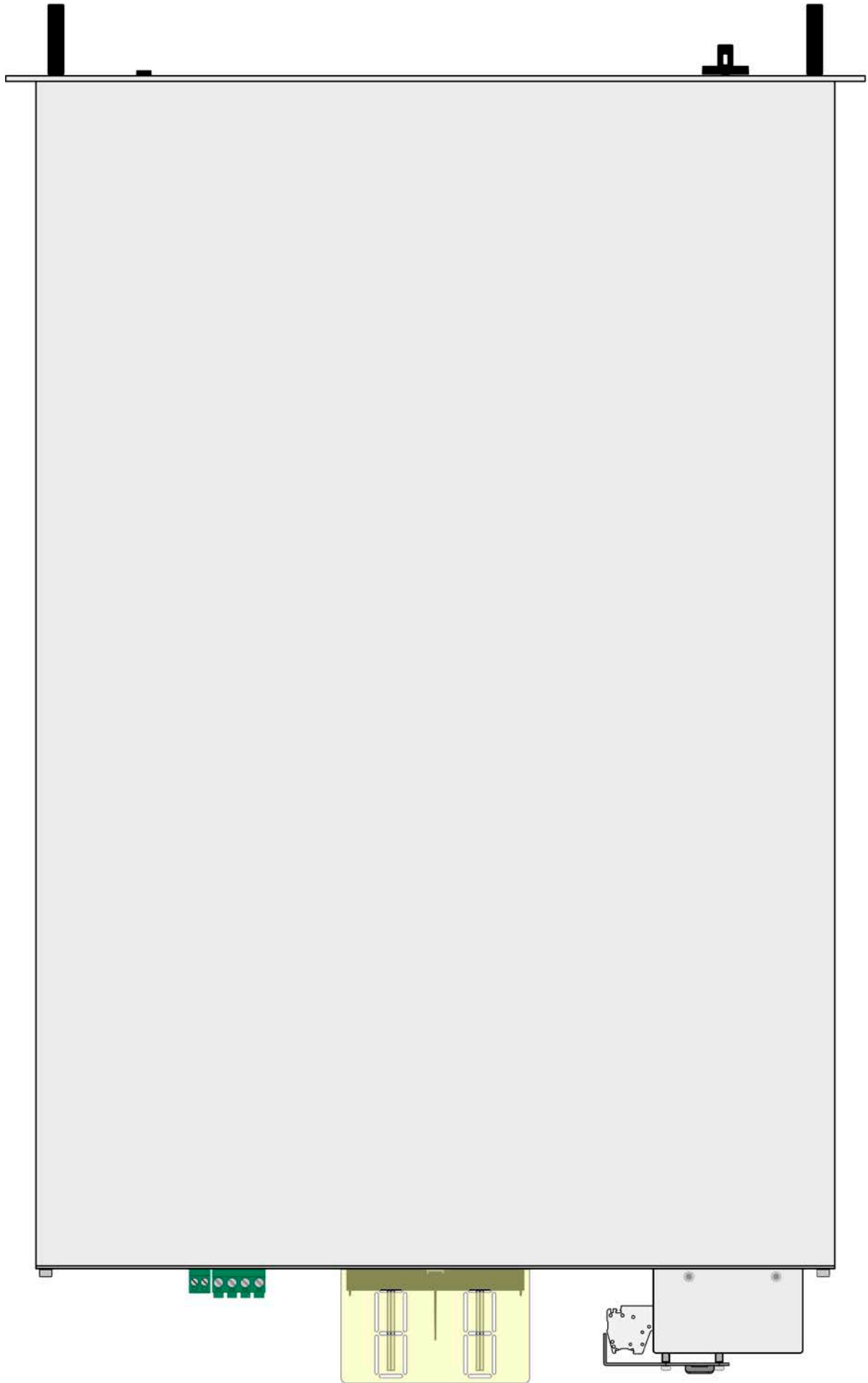

Figure 5 - View from above

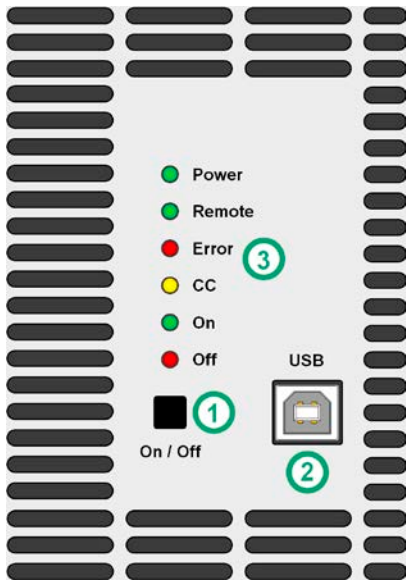

Figure 6 - Control Panel

Overview of the elements on the control panel

For a detailed description see section „1.9.4. The control panel (HMI)“.

(1)	<p>On/Off button</p> <p>Can be used to switch the DC output on or off during manual operation, while LED “Remote” = off</p>
(2)	<p>USB port</p> <p>For quick and easy access to the most important DC output related values when the device is not in master-slave mode. This port has reduced functionality compared to the rear port.</p>
(3)	<p>Status indicators (LED)</p> <p>These six colour LEDs show the device status. For details refer to 1.9.4.</p>

1.9 Construction and function

1.9.1 General description

The electronic high performance power supplies of the PSI 9000 WR 3U Slave are designed to extend the power of compatible models from series PSI 9000 WR 3U. The slave models are reduced to basic functions and will usually run in remote control from a master of a master-slave system. They can be added and connected to existing devices of series PSI 9000 WR 3U.

By default, the devices have an USB port on the rear side which serves various purposes, such as servicing (firmware updates), monitoring during master-slave operation or even remote control when the unit is being used in stand-alone operation.

The additional USB port on the front side is used for quick access to all the DC output related parameters and settings. The configuration via this port can be done with the included software **EA Power Control** (on USB stick) or via any custom made control application.

The devices offer as standard the possibility for parallel connection in Share bus operation to achieve a constant current sharing, plus a genuine master-slave connection with totaling of the slave units' values on the master unit from PSI 9000 WR 3U series. This kind of operation allows for up to 16 units to be combined to a single system with a total power of up to 240 kW.

1.9.2 Block diagram

The block diagram illustrates the main components inside the device and their relationships.

There are digital, microprocessor controlled components (KE, DR, HMI), which can be target of firmware updates.

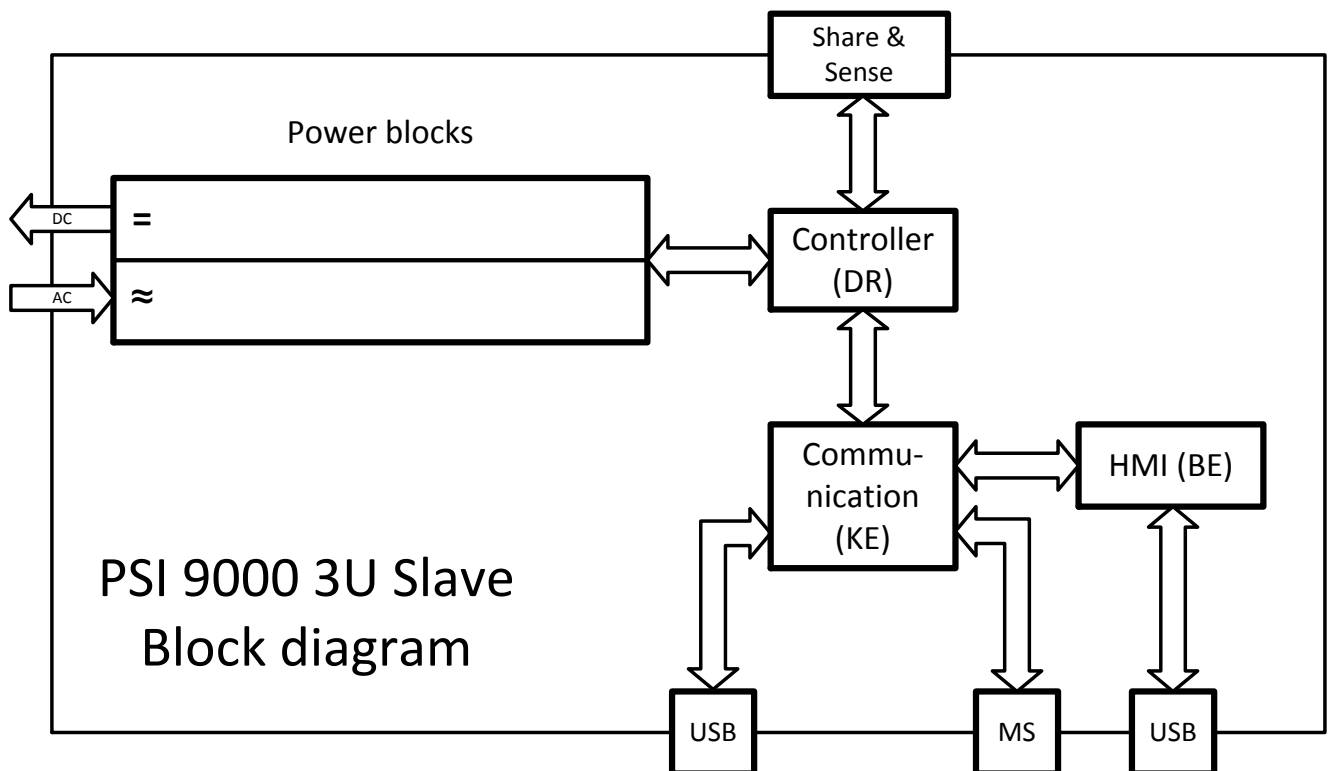

1.9.3 Scope of delivery

- 1 x Power supply device
- 1 x Share Bus plug
- 1 x Remote sensing plug
- 1 x 1.8 m (5.9 ft) USB cable
- 1 x Set of DC terminal covers
- 1 x Share/Sense terminal cover (only with models from 750 V)
- 1 x USB stick with documentation and software
- 1 x AC connector plug (clamp type)
- 1 x Set for strain relief (pre-mounted)

1.9.4 The control panel (HMI)

The HMI (Human Machine Interface) consists of six colored LEDs, a pushbutton and an USB-B port.

1.9.4.1 Status indicators (LED)

The six coloured LEDs on the front indicate various statuses of the device:

LED	Colour	Indicates what when lit?
Power	orange / green	Orange = device is in boot phase or internal error occurred Green = device is ready for operation
Remote	green	Remote control by master or any of the USB ports is active. In this situation, manual control with button On/Off is locked.
Error	red	At least one unacknowledged device alarm is active. The LED can signalise all alarms as listed in „3.6. Alarms and monitoring“.
CC	yellow	Constant current regulation (CC) is active. It means, if the LED is not lit it indicates either CV, CP or CR mode. Also see „3.2. Operating modes“.
On	green	DC output is switched on
Off	red	DC output is switched off

1.9.4.2 USB port

The front USB port is easier to access than the one on the rear side and intended for quick setup of DC output related values and settings. Doing so is only necessary and possible in these two situations:

1. The PSI 9000 WR 3U Slave shall run as stand-alone device which is not controlled by a PSI 9000 WR 3U master.
2. The PSI 9000 WR 3U shall, due to the lack of a suitable PSI 9000 WR 3U master device, be the master of other PSI 9000 WR 3U Slave devices.

Both situations are only secondary, as the primary and normal function of a PSI 9000 WR 3U Slave is to be a slave in a master-slave system where it is assigned all required settings and values from the master.

When running any of the above listed situations following applies to the USB port:



- Reduced instruction set for master-slave configuration, output values (U, I, P, R) and protections (OVP, OCP, OPP). For details about the instruction set see „3.5. Remote control“.
- Taking over remote control in order to change the configuration is only possible while the unit is not online with the master, which either requires to temporarily deactivate master-slave on the master or to switch the master off

1.9.4.3 Pushbutton “On / Off”



This button can be used to switch the DC output on or off during manual control, i.e. the device is not in remote control by a master or via any of the USB ports (LED “Remote” = off). Once pushed to switch the DC output on, the device would regulate the output to the last values it has stored. Since all the output related values are not displayed, operating that button has to be done with caution.

1.9.5 USB port type B (rear side)

The USB-B port on the rear side of the device is provided for communication with the device, i.e. monitoring during master-slave operation or full remote control in stand-alone operation, as well as for firmware updates. The included USB cable can be used to connect the device to a PC (USB 2.0 or 3.0). The driver is delivered with the device and installs a virtual COM port. Details for remote control can be found on the web site of the manufacturer or on the included USB stick.

The device can be addressed via this port either using the international standard ModBus RTU protocol or by SCPI language. The device recognizes the message protocol automatically.

This USB port has no priority over either the other USB port on the front or remote control from a master unit and can, therefore, only be used for remote control alternatively to these. However, monitoring is always available.

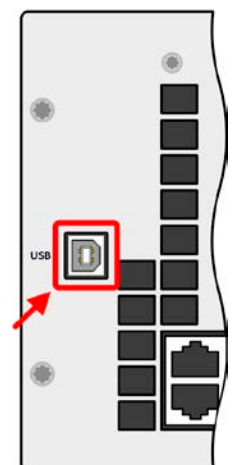

1.9.6 “Share” connector

The 2 pole Phoenix socket “Share” on the rear side of the device is provided for connection to equally named sockets on compatible power supplies series to achieve a balanced load current distribution during parallel connection and constant voltage operation. The socket is also used to connect the power supply to compatible electronic loads, in order to build a two-quadrants operation setup. Following power supply and electronic load series are compatible on the so-called “Share bus”:

- PSI 9000 WR 3U / PSI 9000 3U SLAVE
- PSI 9000 2U - 24U
- ELR 9000
- EL 9000 B / EL 9000 B HP / EL 9000 B 2Q
- PSE 9000
- PS 9000 1U / 2U / 3U *

* From hardware revision 2, see type label of those series (in case it does not show “Revision” on type label, it is revision 1)



1.9.7 “Sense” connector (remote sensing)

The devices of series PSI 9000 WR 3U Slave are supposed to run as slave units in a master-slave system where the remote sensing feature is only used and connected to the master unit. For stand-alone operation outside of a master-slave setup this feature can be wired and used on the Slave mode as well.

In order to compensate for voltage drops along the DC cables to the load, the Sense input can be connected to the load. The maximum possible compensation is given in the technical specifications.

In order to ensure safety and to comply to international directives, insulation of high voltage models, i. e. such with a nominal voltage of 500 V or higher, is ensured by using only the two outer pins of the 4-pole terminal. The inner two pins, marked with NC, must remain unconnected.

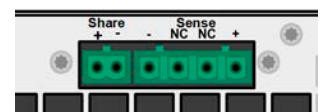

1.9.8 Master-Slave bus

A further port is provided on the rear side of the device, comprising two RJ45 sockets, which enables multiple identical devices to be connected via a digital bus to create a master-slave system. For a PSI 9000 WR 3U Slave device this interface is essential, because it is configured and controlled regarding values and status via this port by a master unit.

Connection is made using standard CAT5 cables. These can theoretically have a length of up to 1200 m (1312 yd), but it is recommended to keep the connections as short as possible.

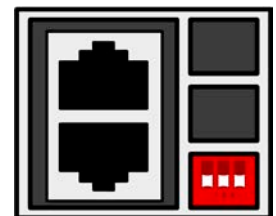

2. Installation & commissioning

2.1 Transport and storage

2.1.1 Transport



- The handles on the front side of the device are **not** for carrying!
- Because of its weight, transport by hand should be avoided where possible. If unavoidable then only the housing should be held and not on the exterior parts (handles, DC output terminal, rotary knobs).
- Do not transport when switched on or connected!
- When relocating the equipment use of the original packing is recommended
- The device should always be carried and mounted horizontally
- Use suitable safety clothing, especially safety shoes, when carrying the equipment, as due to its weight a fall can have serious consequences.

2.1.2 Packaging

It is recommended to keep the complete transport packaging for the lifetime of the device for relocation or return to the manufacturer for repair. Otherwise the packaging should be disposed of in an environmentally friendly way.

2.1.3 Storage

In case of long term storage of the equipment it is recommended to use the original packaging or similar. Storage must be in dry rooms, if possible in sealed packaging, to avoid corrosion, especially internal, through humidity.

2.2 Unpacking and visual check

After every transport, with or without packaging, or before commissioning, the equipment should be visually inspected for damage and completeness using the delivery note and/or parts list (see section „1.9.3. Scope of delivery“). An obviously damaged device (e.g. loose parts inside, damage outside) must under no circumstances be put in operation.

2.3 Installation

2.3.1 Safety procedures before installation and use



- The device may, according to model, have a considerable weight. Therefore the proposed location of the equipment (table, cabinet, shelf, 19" rack) must be able to support the weight without restriction.
- When using a 19" rack, rails suitable for the width of the housing and the weight of the device are to be used (see „1.8.3. Specific technical data“)
- Before connecting to the mains ensure that the supply voltage is as shown on the product label. Overvoltage on the AC supply can cause equipment damage.

2.3.2 Preparation

2.3.2.1 Planning the master-slave system

Before any further planning of installation and wiring it's recommend to decide how the master-slave system shall be configured. The smallest setup would consist of 1x PSI 9000 WR 3U and 1x PSI 9000 WR 3U Slave. Both, master and slave unit, must be of same rating regarding voltage, current and power. Because the PSI 9000 WR 3U Slave models are only available with 15 kW power, they will only match the corresponding models of PSI 9000 WR 3U series. "Match" is here related to the use of the master-slave bus, which wouldn't accept different models. It means, that paralleling a PSI 9080-170 WR 3U with a PSI 9080-510 WR 3U is technically possible and acceptable (due to the same voltage rating), but not supported regarding master-slave.

There are several possible combinations of standard models and Slave models:

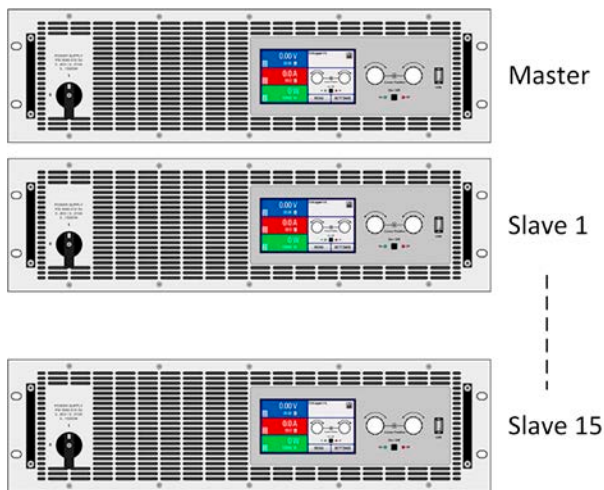

Combination 1:

Multiple PSI 9000 WR 3U (with display)

All models of the standard series can be combined to themselves in master-slave (up to 16 units on one bus)

Advantage of this combination: every unit could be master or slave; the slave show their own actual values and the entire system can also be controlled manually.

Disadvantage of this combination: higher costs compared to a system with PSI 9000 WR 3U Slave models

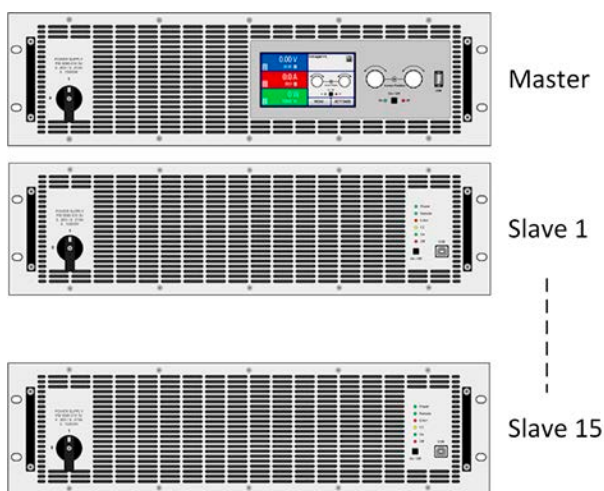

Combination 2:

One PSI 9000 WR 3U with one or multiple PSI 9000 WR 3U Slave

This is the intended combination for models of PSI 9000 WR 3U Slave series, as it can be found in series PSI 9000 15U and PSI 9000 24U, for example.

Advantage of this combination: lower costs

Disadvantages of this combination: in case the master fails, the entire system cannot work. After reconfiguring any Slave unit to be master, which can be done via software and remote control, the system can continue to operate. Other: only 15 kW models of both series can be used.

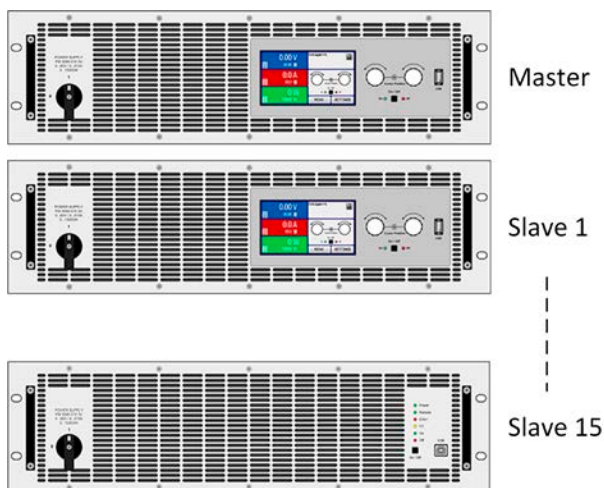

Combination 3:

Multiple PSI 9000 WR 3U with one or multiple PSI 9000 WR 3U Slave

An already existing MS system with only PSI 9000 WR 3U is going to be extended by one or multiple PSI 9000 WR 3U Slave units.

Advantage of this combination: in case of a failing master, any other PSI 9000 WR 3U unit can be quickly reconfigured to be master.

Disadvantages of this combination: higher costs, because even some of the slave units may have a display and control panel which they actually don't need. Other: only 15 kW models of both series can be used.

2.3.2.2 AC supply

AC supply connection for power supply is done via the included 5 pole plug on the rear of the device. Wiring of the plug is always 4 wire (L1+L2+L3+PE) of suitable cross section and length. For recommendations for cable cross section see „2.3.4. Connection to AC supply“. Full configuration, i. e. 3 phases plus PE and also N is acceptable.

2.3.2.3 DC output

Dimensioning of the DC wiring to the load/consumer has to reflect the following:



- The cable cross section should always be specified for at least the maximum current of the device.
- Continuous operation at the approved limit generates heat which must be removed, as well as voltage loss which depends on cable length and heating. To compensate for these the cable cross section should be increased and the cable length reduced.

2.3.3 Installing the device



- Select the location for the device so that the connection to the load is as short as possible.
- Leave sufficient space behind the equipment, minimum 30cm, for ventilation.

A device in a 19" housing will usually be mounted on suitable rails and installed in 19" racks or cabinets. The depth of the device and its weight must be taken into account. The handles on the front are for sliding in and out of the cabinet. Slots on the front plate are provided for fixing the device (fixing screws not included).

Acceptable and unacceptable installation positions:

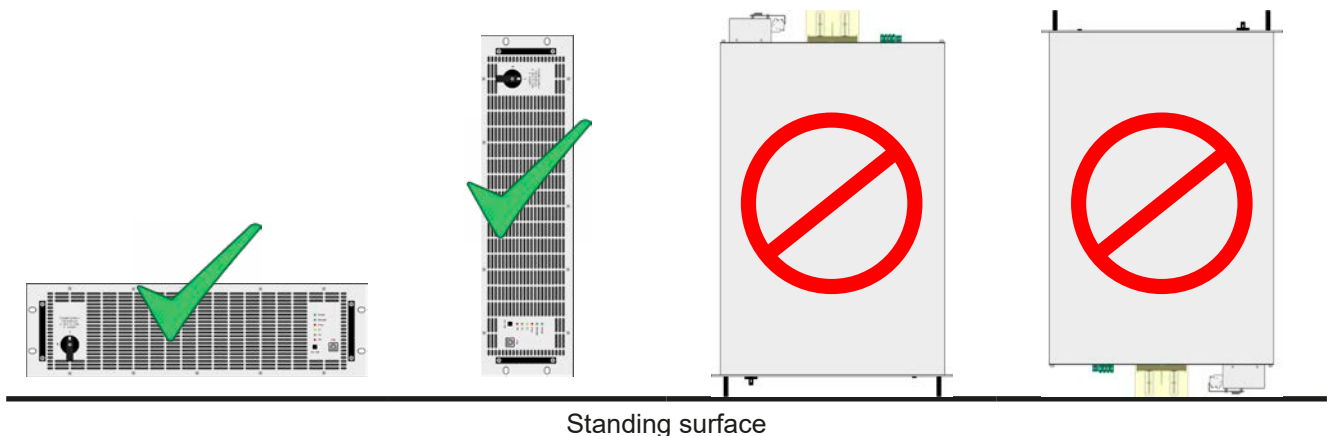

2.3.4 Connection to AC supply



- Connection to an AC mains supply may only be carried out by qualified personnel!
- Cable cross section must be suitable for the maximum input current of the device (see tables below)!
- Before plugging in the input plug ensure that the device is switched off by its mains switch!
- **The PE conductor is imperative and must always be wired!**

The equipment is delivered with a 5 pole mains plug. All models in this series require a 3-phase supply, which has to be connected according to the labeling on the plug. Required for the mains connection are following phases:

Nominal power	Phases	Supply type
15 kW or higher	L1, L2, L3, PE	Three-phase

2.3.4.1 Cross section

For the selection of a suitable cable **cross section** the rated AC current of the device and the cable length are decisive. Based on the connection of a **single unit** the table lists the maximum input current and recommended minimum cross section for each phase:

Nominal power	L1		L2		L3		PE
	\emptyset	I_{max}	\emptyset	I_{max}	\emptyset	I_{max}	\emptyset
15 kW	4 mm ²	28 A	4 mm ²	28 A	4 mm ²	28 A	4 mm ²

2.3.4.2 AC cable

The included connection plug can receive soldered cable ends or such with cable end sleeves of up to 6 mm². The longer the connection cable, the higher the voltage loss due to the cable resistance. Therefore the mains cables should be kept as short as possible or use bigger cross section.

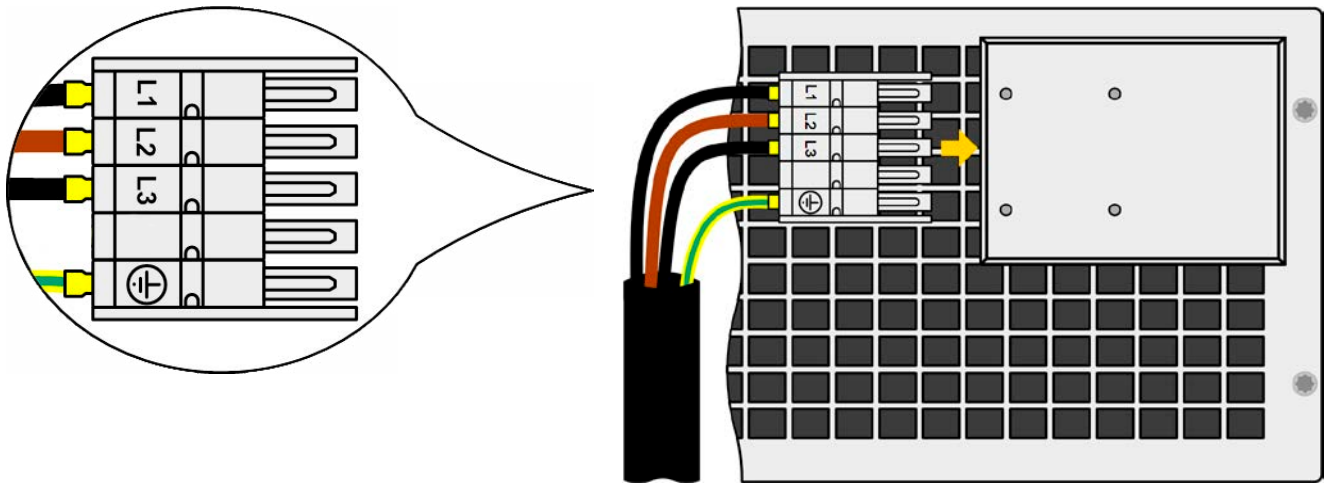

Figure 7 - Example for a mains cable (cable not included in delivery)

2.3.4.3 Strain relief and plug fixture

There is a standard fixture mounted to the AC input connection block on the rear. It is used to prevent the AC plug from loosening and disconnecting due to vibrations or similar. The fixture is also used as strain relief.

Being tied to the AC input block with 4x M3 acorn nuts, it is recommended to mount the fixture every time the AC plug has been removed.

It is furthermore recommended to install the strain relief by using suitable cable straps (not included), as depicted in the figure to the right.

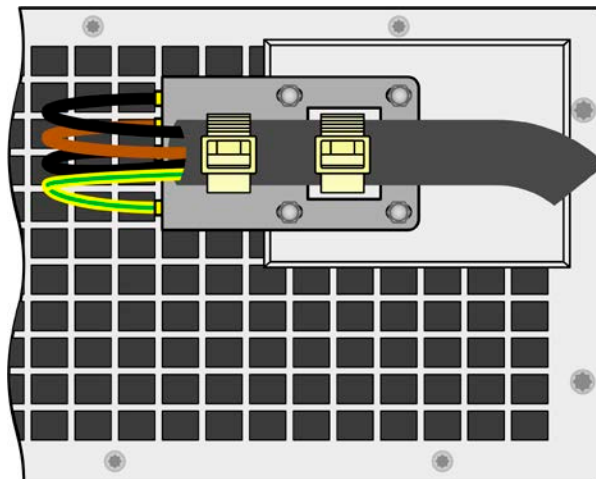

2.3.5 Connection to DC loads



- In the case of a device with a high nominal current and hence a thick and heavy DC connection cable it is necessary to take account of the weight of the cable and the strain imposed on the DC connection. Especially when mounted in a 19" cabinet or similar, where the cable hangs on the DC output, strain reliefs should be installed.
- Connection to and operation with transformerless DC-AC inverters (for example solar inverters) is restricted, because the inverter can shift the potential of negative output (DC-) against PE (ground). Mind the max. allowed potential shift (see technical specifications)!

The DC load output is on the rear side of the device and is **not** protected by a fuse. All models in this series are designed to operate in parallel connection to at least another device of same rating, so the total current of the parallel connection can be between **60 A** (two units) and **8160 A** (sixteen units). From a certain current the use of cables becomes impractical and the use of copper bars is required. The cross section of the connection cables or copper bar is determined by the maximum current, cable length and ambient temperature.

For a parallel connection of **2** units, using flexible cables of up to **5 m** (16.4 ft) length and an average ambient temperature of up to **50 °C** (122 °F) we recommend following cross sections for a total current of:

60 A:	10 mm ²	120 A:	35 mm ²
180 A:	70 mm ²	240 A:	95 mm ²
420 A:	2x 70 mm ²	1020 A:	4x 95 mm ²

per lead (multi-conductor, insulated, openly suspended). Single leads with, for example, 70 mm² cross section can also be replaced by 2x 25 mm² etc. For even longer cables the cross section must be increased to avoid voltage loss and overheating.

2.3.5.1 DC terminal types

The table below shows an overview of the various DC terminals. It is recommended that connection of load cables always utilizes flexible cables with ring lugs.

Type 1: Models up to 360 V output voltage	Type 2: Models from 500 V output voltage
M8 bolt on a metal rail Recommendation: ring lug with a 8 mm hole	M6 bolt on a metal rail Recommendation: ring lug with a 6 mm hole

2.3.5.2 Cable lead and plastic cover

A plastic cover for contact protection is included for the DC terminal. It should always be installed. The cover for type 2 (see picture above) is fixed to the connector itself, for type 1 to the back of the device. Furthermore the cover for type 1 has break outs so that the supply cable can be laid in various directions.

When using copper bars, like they're typical for cabinets, these plastic covers are not used. Instead it is required to make a new one which can cover the entire DC bus.



The connection angle and the required bending radius for the DC cable must be taken into account when planning the depth of the complete device, especially when installing in a 19" cabinet or similar. For type 2 connectors only a horizontal lead can be used to allow for installation of the cover.

Examples of the type 1 terminal:

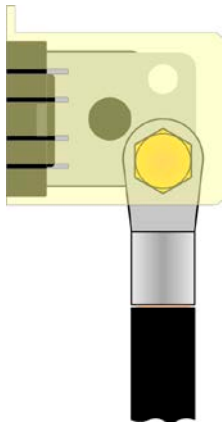

- 90° up or down
- space saving in depth
- no bending radius

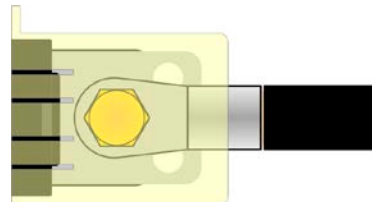

- horizontal lead
- space saving in height
- large bending radius

2.3.6 Grounding of the DC output

Grounding one of the DC terminal poles is permissible, but causes potential shift against PE on the opposite pole. Because of insulation, there is a max. allowed potential shift defined for the DC terminal poles, which depends on the device model. Refer to „1.8.3. Specific technical data“

2.3.7 Connection of remote sense

Important, note: Remote sensing is only for situations when the device is operated stand-alone. Being a slave in a master-slave system, only the master receives the remote sense signal and regulates the slave accordingly via the Share bus.



Both pins „NC“ of the Sense connector must not be wired!



- Remote sensing is only effective during constant voltage operation (CV) and for other regulation modes the sense input should be disconnected, if possible, because connecting it generally increases the oscillation tendency
- The cross section of the sense cables is noncritical. Recommendation for cables up to 5 m (16.4 ft): 0.5 mm²
- Sense cables should be twisted and laid close to the DC cables to damp oscillation. If necessary, an additional capacitor should be installed at the load/consumer to eliminate oscillation
- The + sense cables must be connected to + on the load and - sense to - at the load, otherwise the sense input of the power supply can be damaged. For an example see *Figure 8* below.

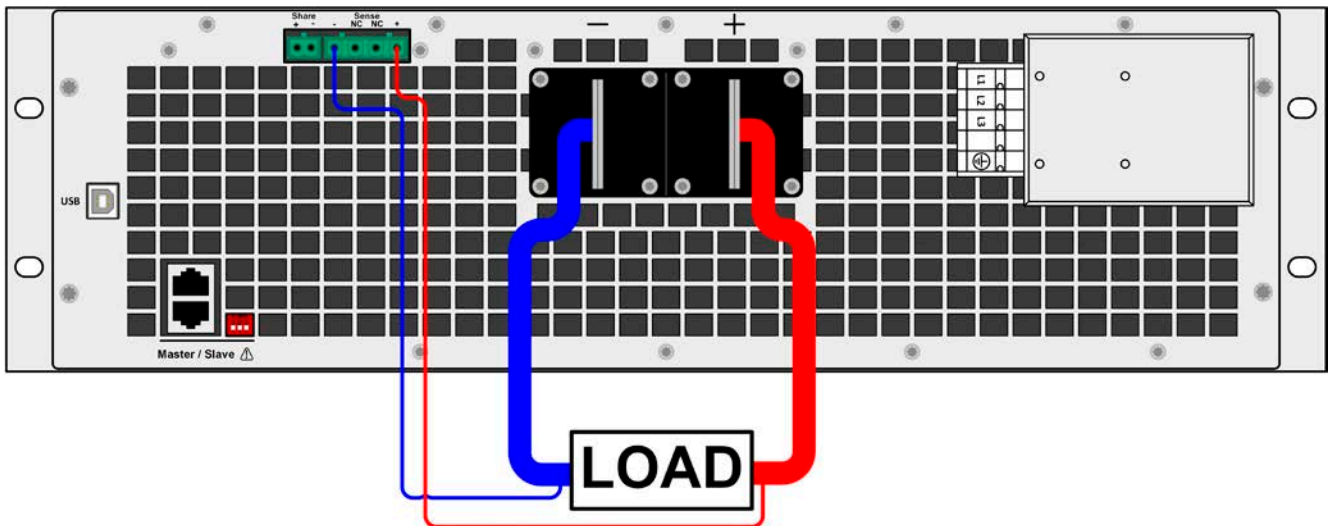

Figure 8 - Example for remote sensing wiring

2.3.8 Connecting the “Share” bus

The “Share” bus connector on the rear side is intended to balance the current of multiple units in parallel operation, especially when using the integrated function generator of the master unit. Alternatively, it can be connected to a compatible electronic load, like from series ELR 9000, in order to run a two-quadrants operation. For further information about this mode of operation can be found in section „3.7.3. Two quadrants operation (2QO)“.

For the connection of the share bus the following must be paid attention to:



- Connection is only permitted between compatible devices (see „1.9.6. “Share” connector“ for details) and between a max. of 16 units
- If a two-quadrants operation system has to be set up where multiple power supplies are connected to one electronic load unit or a group of electronic loads, all units should be connected via Share bus. One power supply unit is then configured as Share bus master, similar to true master-slave operation. The group of power supplies may use the master-slave bus for true master-slave operation, the group of loads may not, because there must be only one master unit on the Share bus.
- When not using one or several units of a system configured with Share bus, because less power is required for an application, it is recommended to disconnect the unit's from the Share bus, because even when not powered they can have a negative impact on the control signal on the bus due to their impedance. Disconnection can be done by simply unplugging them from the bus or using switches.

2.3.9 Connecting the USB port

In order to remotely control the device via the USB ports, connect the device with a PC using the included USB cable and switch the device on.

2.3.9.1 Driver installation (Windows)

On the initial connection with a PC the operating system will identify the device as new hardware and will try to install a driver. The required driver is for a Communications Device Class (CDC) device and is usually integrated in current operating systems such as Windows 7 or 10. But it is strongly recommended to use and install the included driver installer (on USB stick) to gain maximum compatibility of the device to our softwares.

2.3.9.2 Driver installation (Linux, MacOS)

We cannot provide drivers or installation instructions for these operating systems. Whether a suitable driver is available is best carried out by searching the Internet.

2.3.9.3 Alternative drivers

In case the CDC drivers described above are not available on your system, or for some reason do not function correctly, commercial suppliers can help. Search the Internet for suppliers using the keywords “cdc driver windows“ or “cdc driver linux“ or “cdc driver macos“.

2.3.10 Initial commission

For the first start-up after installation of the device, the following procedures have to be executed:

- Confirm that the connection cables to be used are of a satisfactory cross section!
- Check if the factory settings of set values, safety and monitoring functions and communication are suitable for your intended application of the device and adjust them if required, as described in the manual!
- In case of remote control via PC, read the additional documentation for interfaces and software!
- In case of remote control via the analog interface, read the section in this manual concerning analog interfaces!

2.3.11 Commission after a firmware update or a long period of non-use

In case of a firmware update, return of the equipment following repair or a location or configuration change, similar measures should be taken to those of initial start up. Refer to „2.3.10. *Initial commission*“.

Only after successful checking of the device as listed may it be operated as usual.

3. Operation and application

3.1 Personal safety



- In order to guarantee safety when using the device, it is essential that only persons operate the device who are fully acquainted and trained in the required safety measures to be taken when working with dangerous electrical voltages
- For models which can generate a voltage which is dangerous by contact, or is connected to such, the included DC terminal cover, or an equivalent, must always be used
- Whenever the load and DC output are being re-configured, the device should be disconnected from the mains, not only the DC output switched off!

3.2 Operating modes

A power supply is internally controlled by different control or regulation circuits, which shall bring voltage, current and power to the adjusted values and hold them constant, if possible. These circuits follow typical laws of control systems engineering, resulting in different operating modes. Every operating mode has its own characteristics which is explained below in short form.



- *Unloaded operation is not considered as a normal operation mode and can thus lead to false measurements, for example when calibrating the device*
- *The optimal working point of the device is between 50% and 100% voltage and current*
- *It is recommended to not run the device below 10% voltage and current, in order to make sure technical values like ripple and transient times can be met*
- *The models of this series are usually regulated via the Share bus from a master unit, but can also be used stand-alone*

3.2.1 Voltage regulation / Constant voltage

Voltage regulation is also called constant voltage operation (CV).

The DC output voltage of a power supply is held constant on the adjusted value, unless the output current or the output power according to $P = U_{OUT} \cdot I_{OUT}$ reaches the adjusted current or power limit. In both cases the device will automatically change to constant current or constant power operation, whatever occurs first. Then the output voltage can't be held constant anymore and will sink to a value resulting from Ohm's law.

3.2.1.1 Transient time after load step

For constant voltage mode (CV), the technical date "Transient time after load step" (see 1.8.3) defines a time that is required by the internal voltage regulator of the device to settle the output voltage after a load step. Negative load steps, i.e. high load to lower load, will cause the output voltage to overshoot for a short time until compensated by the voltage regulator. The same occurs with a positive load step, i.e. low load to high load. There the output collapses for a moment. The amplitude of the overshoot resp. collapse depends on the device model, the currently adjusted output voltage and the capacity on the DC output and can thus not be stated with a specific value.

Depictions:

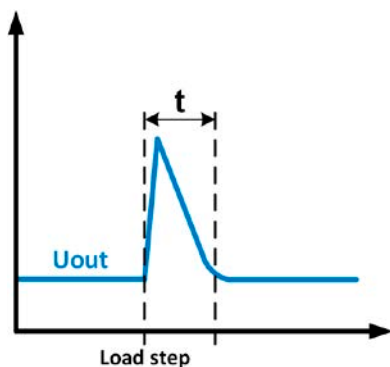

Example for neg. load step: the DC output will rise above the adjusted value for a short time. t = transient time to settle the output voltage.

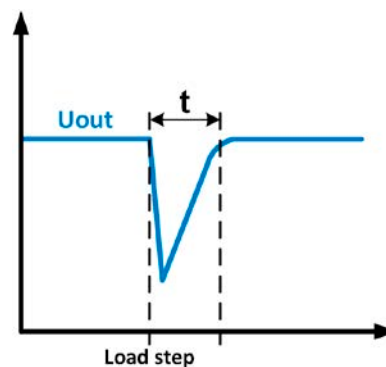

Example for pos. load step: the DC output will collapse below the adjusted value for a short time. t = transient time to settle the output voltage.

3.2.2 Current regulation / constant current / current limiting

Current regulation is also known as current limiting or constant current mode (CC).

The DC output current is held constant by the power supply, once the output current to the load reaches the adjusted limit. Then the power supply automatically switches to CC. The current flowing from the power supply is determined by the output voltage and the load's true resistance. As long as the output current is lower than the adjusted current limit, the device will be either in constant voltage or constant power mode. If, however, the power consumption reaches the set maximum power value, the device will switch automatically to power limiting and sets the output current according to $I_{MAX} = P_{SET} / U_{IN}$, even if the maximum current value is higher. The current set value, as determined by the user, is always an upper limit only.

While the DC output is switched on and constant current mode is active, then the condition "CC mode active" will be indicated via LED "CC" and stored as status which can also be read as a status message via digital interface.

3.2.3 Power regulation / constant power / power limiting

Power regulation, also known as power limiting or constant power (CP), keeps the DC output power of a power supply constant if the current flowing to the load in relation to the output voltage and the resistance of load reaches the adjusted value according to $P = U * I$ resp. $P = U^2 / R$. The power limiting then regulates the output current according to $I = \text{sqr}(P / R)$, where R is the load's resistance.

Power limiting operates according to the auto-range principle such that at lower output voltages higher current flows and vice versa in order to maintain constant power within the range P_N (see diagram to the right).

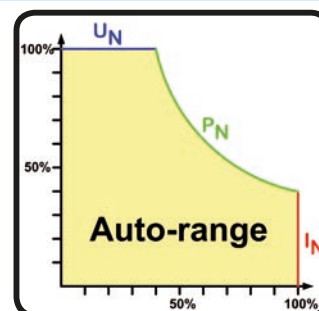

When using remote sensing, the power supply can deliver a higher voltage on the DC output than adjusted, which results in additional power and may also cause the device to enter power limitation without explicitly indicating.

3.2.4 Internal resistance regulation

Internal resistance control (abbr. CR) of power supplies is the simulation of a virtual internal resistor which is in series to the voltage source and thus also in series to the load. According to Ohm's law, this causes a voltage drop, which will result in a difference between adjusted output voltage and actual output voltage. This will work in constant current mode as well as in constant power mode, but here the output voltage will differ even more from the adjusted voltage, because then constant voltage is not active.

The adjustable resistance range is generally defined between 0 and $30 * U_{NOM} / I_{NOM}$ of the particular model. The voltage setting in dependency of the resistance set value and the output current is done by calculation of the microcontroller and thus will be slower the other controllers inside the control circuit. Clarification:

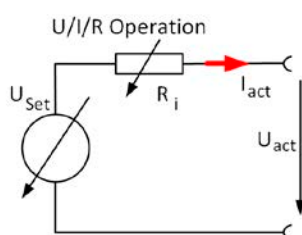
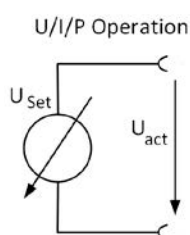

$$U_{Act} = U_{Set} - I_{Act} * R_{Set} \quad | \quad P_{Set}, I_{Set}$$

$$P_{Ri} = (U_{Set} - U_{Act}) * I_{Act}$$



With resistance mode being active, i.e. mode R/I, the function generator will be inaccessible.

3.3 Alarm conditions



This section only gives an overview about device alarms. What to do in case your device indicates an alarm condition is described in section „3.6. Alarms and monitoring“.

As a basic principle, all alarm conditions are signaled optically (by LED “Error” on the front) and via the digital interface ports. For later acquisition, an alarm counter can be read via digital interface.

Some alarms require acknowledgment before the DC output can be switched on again, in those cases where the alarm caused the DC output to switch off. Acknowledgment in normal master-slave operation is done on the master unit. In other situations, like during manual operation it can be done with the pushbutton “On / Off” on the front or else by sending a specific command via digital interface.

3.3.1 Power Fail

Power Fail (PF) indicates an alarm condition which may have various causes:

- AC input voltage too low (mains undervoltage, mains failure)
- Defect in the input circuit (PFC)

As soon as a power fail occurs, the device will stop to supply power and switch off the DC output. In case the power fail was an undervoltage and is gone later on, the alarm will vanish and doesn't require to be acknowledged.



Switching off the device by the mains switch can't be distinguished from a mains blackout and thus the device will signalize an alarm via LED “Error” every time the device is switched off. This can be ignored.



The condition of the DC output after a PF alarm during operation when the device remains powered, i.e. like after a temporary blackout, can be set up via a specific command.

3.3.2 Overtemperature

An overtemperature alarm (OT) can occur from an excess temperature inside the device and temporarily causes it to stop supplying power. After cooling down, the device will automatically continue to supply power, while the condition of the DC output remains and the alarm doesn't require to be acknowledged.

3.3.3 Overvoltage protection

An overvoltage alarm (OVP) will switch off the DC output and can occur if:

- the power supply itself, as a voltage source, generates an output voltage higher than set for the overvoltage alarm threshold (OVP, 0...110% U_{Nom}) or the connected load somehow returns voltage higher than this threshold.
- the OVP threshold has been adjusted too close above the output voltage. If the device is in CC mode and if it then experiences a negative load step, it will make the voltage rise quickly, resulting in a voltage overshoot for a short moment which can already trigger the OVP.

This function serves to warn the user of the power supply that the device probably has generated an excessive voltage which could damage the connected load application.



- The device is not fitted with protection from external overvoltage
- The changeover from operation modes CC -> CV can generate voltage overshoots

3.3.4 Overcurrent protection

An overcurrent alarm (OCP) will switch off the DC output and can occur if:

- the output current in the DC output reaches the adjusted OCP limit.

This function serves to protect the connected load application so that this is not overloaded and possibly damaged due to an excessive current.

3.3.5 Overpower protection

An overpower alarm (OPP) will switch off the DC output and can occur if:

- the product of the output voltage and output current in the DC output reaches the adjusted OPP limit.

This function serves to protect the connected load application so that this is not overloaded and possibly damaged due to an excessive power consumption.

3.3.6 Safety OVP

This extra feature is **only built into the 60 V model** of this series. Similar to the regular overvoltage protection (OVP, see 3.3.3), the Safety OVP is supposed to protect the application or people according to SELV. The alarm shall prevent the device from providing an output voltage higher than 60 V. However, the alarm could also be triggered by an external source providing an excess voltage to the DC input of the device.

A safety OVP alarm can occur if

- the voltage on the DC of the device reaches the rigid threshold of 60.6 V.

If the voltage on the DC terminal exceeds that level for any reason, the DC terminal will be switched off and alarm "Safety OVP" will be signaled via LED "Error". This alarm can't be acknowledged the usual way. It requires to power-cycle the unit.



During normal operation of the power supply, this alarm should not trigger. There are, however, situations which can trigger the alarm, like when working with voltages close to the threshold of 60.6 V or voltage spikes when leaving CC mode when the current was 0 A before.



When remote sensing is used, i. e. the rear input "Sense" is connected, the true output voltage (source mode) is higher than set value so the Safety OVP could already trigger at voltage settings lower than 60 V.

3.4 Manual operation

Manual operation is a secondary functionality for this type of device. It is intended to run under constant remote control by a master unit. Thus the number of available functions in manual control is reduced, compared to a standard PSI 9000 WR 3U device.

3.4.1 Powering the device

The device should, as far as possible, always be switched on using the rotary switch on the front of the device. Alternatively this can take place using an external cutout (contactor, circuit breaker) of suitable current capacity.

In a master-slave system it is normal that not all units are powered at the same time or some units not at all. In order for the master to initialize all slaves correctly it will wait some time after start. In case not all slaves have been initialized the procedure to find and enumerate the slave can be repeated, either directly on the screen of the master, here a device from PSI 9000 WR 3U series, or in the MENU. Alternatively, this can also be done via remote control.

After switching on, the device indicates the boot phase with LED "Power" on the front being **orange**. Once it has finished starting and is ready for operation, LED "Power" changes to **green**.

There is a configurable option which determines the condition of the DC output after power-up. Factory setting here is "OFF". Changing it to "Restore" will cause the device to restore the last DC output condition, either on or off.

In master-slave operation and when the device is being slave, which is the default mode of operation for models of this series, all values and conditions are stored and restored by the master, overwriting the slaves' settings.

3.4.2 Switching the device off

On switch-off the last output condition and the most recent set values are saved. Furthermore, a PF alarm (power failure) will be signaled via LED "Error", but can be ignored.

The DC output is immediately switched off and after a short while fans will shut down and after another few seconds the device will be completely powered off.

3.4.3 Switching the DC output on or off

As long as the Slave unit is not in remote control by a master unit or by a software via USB interface, the DC output can be manually switched on or off with the pushbutton "On / Off". This is for situations where the Slave device needs to be operated stand-alone or as substitute of a failed or missing master. The same situation also allows for access to all DC output related parameters via the front USB port. The button can also be used to acknowledge device alarms signaled by LED "Error".

Configuration of parameters via one of the USB ports is considered as remote control and is thus described in 3.5.

3.5 Remote control

3.5.1 General

Remote control is essential when operating devices of this series, for example during master-slave. It is furthermore possible to take over remote via one of the built-in USB ports. Important here is that only one of the digital interfaces or a master unit can be in control. It means that if, for example, an attempt were to be made to switch to remote control via the digital interface whilst master-slave mode is running the device would report an error via the digital interface. In the opposite direction, the master unit could not initialize a Slave unit being in USB remote control. In both cases, however, status **monitoring** and reading of values via any of the USB ports is always possible.

3.5.2 Remote control via the rear USB

The rear USB port offers the same set of commands as with a “normal” PSI 9000 WR 3U device, but only while the Slave device is not in control by a master device or currently not in status “Slave”. Then the same programming documentation “Programming SCPI & ModBus” is valid for the user, as well as the ModBus register list “Modbus_Register_PSI9000_KEx.xx+_EN.pdf”.

Control via software EA Power Control is also possible via this port and unrestricted.

3.5.3 Remote control via the front USB

The main purpose of the front USB port is quick access to the most important DC output related parameters, such as set values and protections. Reading values and status is always possible, setting them only while the Slave device is not in control by a master device.

Outside of master-slave, the device could be controlled remotely with software **EA Power Control**, but also from custom applications. In order to do so, a programming documentation is delivered with the device on USB stick.

The number of available commands is restricted on this USB port, but it supports both, SCPI and ModBus RTU communication protocols. As part of the programming documentation, there is an **extra ModBus register list** (Modbus_Register_PSI9000_Slave_Front_HMIx.xx+_EN.pdf) for the front USB port.

In the programming guide there is a section for all SCPI commands, as available with the rear USB port. Here is an overview what commands are available with the front port. Details about the commands can be found in the “Programming SCPI & ModBus” document, also called **programming guide**.

*IDN?	[SOURce:]VOLTage
*CLS	[SOURce:]VOLTage?
*RST	[SOURce:]VOLTage:LIMit:HIGH?
*ESE	[SOURce:]VOLTage:LIMit:LOW?
*ESE?	[SOURce:]VOLTage:PROTection[:LEVel]
*ESR	[SOURce:]VOLTage:PROTection[:LEVel]?
*STB?	MEASure:[SCALAR:]CURRent[:DC]?
[SOURce:]CURRent	MEASure:[SCALAR:]POWer[:DC]?
[SOURce:]CURRent?	MEASure:[SCALAR:]VOLTage[:DC]?
[SOURce:]CURRent:LIMit:HIGH?	OUTPut[:STATe]
[SOURce:]CURRent:LIMit:LOW?	OUTPut[:STATe]?
[SOURce:]CURRent:PROTection[:LEVel]	STATus:OPERation?
[SOURce:]CURRent:PROTection[:LEVel]?	STATus:QUEStionable?
[SOURce:]IRRAdiation	SYSTem:ALARm:ACTion:PFail
[SOURce:]IRRAdiation?	SYSTem:ALARm:ACTion:PFail?
[SOURce:]POWer	SYSTem:ALARm:COUNt:OCURrent?
[SOURce:]POWer?	SYSTem:ALARm:COUNt:OPOWer?
[SOURce:]POWer:LIMit:HIGH?	SYSTem:ALARm:COUNt:OTEMperature?
[SOURce:]POWer:LIMit:LOW?	SYSTem:ALARm:COUNt:OVOLTage?
[SOURce:]POWer:PROTection[:LEVel]	SYSTem:ALARm:COUNt:PFail?
[SOURce:]POWer:PROTection[:LEVel]?	SYSTem:COMMunicate:TIMEOUT?
[SOURce:]RESistance	SYSTem:CONFig:MODE
[SOURce:]RESistance?	SYSTem:CONFig:MODE?
[SOURce:]RESistance:LIMit:HIGH?	SYSTem:CONFig:OCD

SYSTem:CONFIg:OCD?	SYSTem:CONFIg:USER:TEXT?
SYSTem:CONFIg:OCD:ACTIon	SYSTem:CONFIg:UVD
SYSTem:CONFIg:OCD:ACTIon?	SYSTem:CONFIg:UVD?
SYSTem:CONFIg:OPD	SYSTem:CONFIg:UVD:ACTIon
SYSTem:CONFIg:OPD?	SYSTem:CONFIg:UVD:ACTIon?
SYSTem:CONFIg:OPD:ACTIon	SYSTem:DEVIce:CLAss?
SYSTem:CONFIg:OPD:ACTIon?	SYSTem:ERRor:ALL?
SYSTem:CONFIg:OUTPut:REStore	SYSTem:ERRor:NEXt?
SYSTem:CONFIg:OUTPut:REStore?	SYSTem:ERRor?
SYSTem:CONFIg:OVD	SYSTem:LOCK
SYSTem:CONFIg:OVD?	SYSTem:LOCK?
SYSTem:CONFIg:OVD:ACTIon	SYSTem:LOCK:OWNer?
SYSTem:CONFIg:OVD:ACTIon?	SYSTem:NOMInal:CURRent?
SYSTem:CONFIg:UCD	SYSTem:NOMInal:POWer?
SYSTem:CONFIg:UCD?	SYSTem:NOMInal:RESistance:MAXimum?
SYSTem:CONFIg:UCD:ACTIon	SYSTem:NOMInal:RESistance:MINimum?
SYSTem:CONFIg:UCD:ACTIon?	SYSTem:NOMInal:VOLTage?

3.5.4 Programming

Programming details about the communication protocols etc. are to be found in the documentation "Programming Guide ModBus & SCPI" which is supplied on the included USB stick or which is available as download from the manufacturer's website.

3.6 Alarms and monitoring

3.6.1 Definition of terms

The device signalizes alarms (see „3.3. Alarm conditions“) such as overvoltage (OV) or overheating (OT) via the front LED “Error” and as readable status via digital interface. When running the device as Slave as part of a master-slave system, the alarm is also reported to the master and if the master is with display, the alarm is indicated there as well. Basically, device alarms will switch off the DC output, primarily in order to protect the connected load and secondarily to protect the device itself.

Monitoring or supervision is also available in form of user-definable events. Configuration of alarm thresholds and events, as well as reading status can only be done via the USB ports.

3.6.2 Device alarm and event handling

A device alarm incident will usually lead to DC output switch-off and the front LED “Error” is lit to make the user aware. Some alarms must be acknowledged. While the Slave device is in control of a master device, all alarms are acknowledged on the master unit. Refer to the user manual of the master. After acknowledging the alarm on the master, the LED “Error” on the alarm causing slave unit should be off.

For all other situations, the front button “On / Off” or a specific command sent via digital interface in remote control is used to acknowledge alarms.

► How to acknowledge an alarm (during manual control)

1. In case the DC output is switched off and the LED “Error” is lit, use button “On / Off”.
2. The LED should go off and with another push on “On / Off”, the DC output could be switched on again. If the LED remains lit, the alarm cause could still be present.

Some device alarms, specifically their thresholds, are configurable via **EA Power Control** software or custom tools:

Short	Long	Description	Range
OVP	OverVoltage Protection	Triggers an alarm if the DC output voltage reaches the defined threshold. The DC output will be switched off.	0 V...1.1*U _{Nom}
OCP	OverCurrent Protection	Triggers an alarm if the DC output current reaches the defined threshold. The DC output will be switched off.	0 A...1.1*I _{Nom}
OPP	OverPower Protection	Triggers an alarm if the DC output power reaches the defined threshold. The DC output will be switched off.	0 W...1.1*P _{Nom}

These device alarms can't be configured and are based on hardware:

Short	Long	Description
PF	Power Fail	AC supply over- or undervoltage. Triggers an alarm if the AC supply is out of specification or when the device is cut from supply, for example when switching it off with the power switch. The DC output will be switched off.
OT	OverTemperature	Triggers an alarm if the internal temperature reaches a certain limit. The DC output will be switched off.
MSP	Master-Slave Protection	Triggers an alarm if the master unit loses contact to any slave unit. The DC output will be switched off. The alarm can be cleared by reinitializing the MS system.
SOVP	Safety OverVoltage Protection	Only featured in the 60 V model: Triggers a special OVP alarm if the voltage on the DC terminal exceeds the rigid threshold of 101% rated voltage. The DC terminal will be switched off. For details refer to section 3.3.6

3.6.2.1 User defined events

The monitoring functions of the device can be configured for user defined events. By default, events are deactivated (action = NONE). Contrary to device alarms, the events only work while the DC output is switched on. It means, for instance, that you cannot detect undervoltage (UVD) anymore after switching the DC output off and the voltage is still sinking.

The following events can be configured independently and can in each case trigger the actions NONE, SIGNAL, WARNING or ALARM.

Action	Impact
NONE	User defined event is disabled.
SIGNAL/WARNING	On reaching the condition which triggers the event with action SIGNAL or WARNING a bit in the status register of the device will be set. That register can be read via USB. With this series, actions SIGNAL and WARNING are equal.
ALARM	On reaching the condition which triggers the event with action ALARM a bit in the status register of the device will be set and the DC output will be switched off. Both conditions can be read via USB from the status register.

Event	Meaning	Description	Range
UVD	UnderVoltage Detection	Triggers an event if the output voltage falls below the defined threshold.	0 V...U _{Nom}
OVD	OverVoltage Detection	Triggers an event if the output voltage exceeds the defined threshold.	0 V...U _{Nom}
UCD	UnderCurrent Detection	Triggers an event if the output current falls below the defined threshold.	0 A...I _{Nom}
OCD	OverCurrent Detection	Triggers an event if the output current exceeds the defined threshold.	0 A...I _{Nom}
OPD	OverPower Detection	Triggers an event if the output power exceeds the defined threshold.	0 W...P _{Nom}

As soon as an event is set up with an action other than "NONE" while the DC output is still switched on, it can immediately occur and switch the DC output off. It is thus recommended to configure events only while the DC output is switched off.

3.7 Other applications

3.7.1 Parallel operation in master-slave (MS)

Running the Slave models of series PSI 9000 WR 3U Slave in master-slave operation is the primary function. The devices will work as slave units which are enumerated and controlled by a master device. Instructions for configuration and use of a master-slave system where a standard model with display from series PSI 9000 WR 3U is master can be found in the user manual of PSI 9000 WR 3U series.

This section is about a different situation where a Slave model is supposed to be the master unit as substitute of a missing or not matching master model. Running the Slave as master is basically possible, though all setup and control is only done via the USB ports and by software. Since the front USB port is restricted in its functions and does not support master-slave configuration, we recommend to use the rear USB port for all communication.

3.7.1.1 Introduction

Multiple devices with identical ratings can be connected in parallel in order to create a system with higher total current and hence higher power. This can be done using the standard models with display or the new slave models (PSI 9000 WR 3U Slave, available since mid of 2017). Only disadvantage: the slave models are only available as 15 kW versions, so they only match the 15 kW standard models.

For parallel operation in master-slave mode the units are usually connected with their DC outputs, their Share bus and their master-slave bus. The master-slave bus is a digital bus which makes the system work as one big unit regarding adjusted values, actual values and status.

The Share bus is intended to balance the units dynamically in their power, especially if the master unit runs a function. In order for this bus to work correctly, at least the DC minus poles of all units have to be connected, because DC minus is the reference for the Share bus.

3.7.1.2 Restrictions

Compared to normal operation of a single device, master-slave operation has some *restrictions*:

- The MS system reacts differently in alarm situations (see below in 3.7.1.7)
- Using the Share bus makes the system react as dynamic as possible, but it is still not as dynamic as single unit operation

3.7.1.3 Wiring the DC outputs

The DC output of every unit in the parallel operation is connected with correct polarity to the next unit, using cables with cross section according to the maximum current and with as short as possible length.

3.7.1.4 Wiring the Share bus

The Share bus is wired from unit to unit with an ideally twisted pair of cables with non-critical cross section. We recommend to use 0.5 mm² to 1.0 mm².



- The Share bus is poled. Take care for correct polarity of the wiring!
- In order for the Share bus to work correctly it requires at least to connect all DC minus outputs of the devices



A max. of 16 units can be connected via Share bus.

3.7.1.5 Wiring and set-up of the digital master-slave bus

The master-slave connectors are built-in and can be connected via network cables (≥CAT3, patch cable). After this, MS can be configured manually (recommended) or by remote control. The following applies:

- A maximum of 16 units can be connected via the bus: 1 master and up to 15 slaves.
- Only devices of same rating, i.e. power supply to power supply, and of the same model, such as PSI 9080-510 WR 3U to PSI 9080-510 WR 3U Slave or also PSI 9080-510 WR 3U Slave with PSI 9080-510 WR 3U Slave.
- Units at the end of the bus must be terminated (see below)



The master-slave bus must not be wired using crossover cables!

Later operation of the MS system implies:

- The master unit calculates the sum of the actual values of all the units and makes them available to read via the digital interfaces
- The ranges for setting the values, adjustment limits, protections (OVP etc.) and user events (UVD etc.) of the master are adapted to the total number of units. Thus, if e.g. 5 units each with a power of 15 kW are connected together to a 75 kW system, then the master can be set in the range 0...75.00 kW.
- Slaves are no operable as long as being controlled by the master
- Slaves will show "Alarm: MSP" as long as they're not initialized by the master. This is handled the same way as a connection drop to the master unit.

► How to connect the digital master-slave bus

1. Switch off all units that are to be connected and connect them with network cables (CAT3 or better, 1x cable per Slave unit included). It doesn't matter which of the two master-slave connection sockets (RJ45, backside) is connected to the next unit.
2. Depending on the desired configuration the units can then be connected at the DC side.
3. The two units at the beginning and end of the chain should be terminated, if long connection cables are used. This is achieved using a 3-pole DIP switch which is positioned on the rear side of the unit next to the MS connectors.



Now the master-slave system has to be configured on each other unit. It is recommended to configure first all the slave units and then the master unit.

The configuration itself can be done with **EA Power Control** or custom software. The programming guide, as included in the delivery on USB stick, explains remote configuration for master-slave in custom applications.

3.7.1.6 Operating the master-slave system

After the first initialization after any reconfiguration of the system the master can be operated and controlled like a single stand-alone unit. While software **EA Power Control** automatically detects MS mode and adapts the rated values to what the MS system represents, this has to be considered in custom applications. The master will offer a set of system ratings, readable with extra registers resp. SCPI commands. These ratings could change every time the system is initialized for master-slave, depending on the number of slaves.

The following applies:

- The master can be treated like a standalone unit
- The master shares the set values across the slaves and controls them
- The master is remotely controllable via the analog or digital interfaces
- All settings for the set values U, I and P (supervision, limits etc.) should be adapted to the new total values
- All initialized slaves will reset any limits (U_{Min} , I_{Max} etc.), supervision thresholds (OVP, OPP etc.) and event settings (UCD, OVD etc.) to default values, so these don't interfere the control by the master. As soon as these values are modified on the master, they are transferred 1:1 to the slaves. Later, during operation, it might occur that a slave causes an alarm or event rather than the master, due to imbalanced current or slightly faster reaction.
- If one or more slaves report an device alarm, it will be indicated on the master and must be acknowledged there so that the slave(s) can continue their operation. Since an alarm causes the DC output to switch off and it can only reinstate automatically after PF or OT alarms, it can be required to switch it on again by the operator or by a remote control software.
- Loss of connection to any slave will result in shutdown of all DC outputs as a safety measure and the master will report this situation with LED "Error" and status readable via USB. Then the MS system has to be re-initialized, either with or without re-establishing connection to the disconnected unit(s) before.

3.7.1.7 Alarms and other problem situations

Master-slave operation, due to the connection of multiple units and their interaction, can cause additional problem situations which do not occur when operating individual units. For such situations the following regulations have been defined:

- Generally, if the master loses connection to any slave, it will generate an MSP (master-slave protection) alarm, pop up a message on the screen and switch off its DC output. The slaves will fall back to single operation mode, but also switch off their DC output. The MSP alarm can be deleted by either initializing the master-slave system again. This can be done either in the MSP alarm pop-up screen or in the MENU of the master or via remote control. Alternatively, the alarm is also cleared by deactivating master-slave on the master unit
- If one or more slave units are cut from AC supply (power switch, blackout, supply undervoltage) while the master is still running and they come back later, they're not automatically initialized and included again in the MS system. Then the initialization has to be repeated.
- If the DC output of the master unit is switched off due to a defect or overheating, then the total master-slave system cannot provide output power and the DC outputs of all slaves are automatically switched off, too
- If the master unit is cut from AC supply (power switch, blackout) and comes back later, the unit will automatically initialize the MS system again, finding and integrating all active slaves. In this case, MS can be restored automatically.
- If accidentally multiple or no units are defined as master the master-slave system cannot be initialized

In situations where one or multiple units generate a device alarm like OV etc. following applies:

- Any alarm of a slave is indicated on the slave's HMI and on the master's display
- If multiple alarms happen simultaneously, the master only indicates the most recent one. In this case, the particular alarms can be read from the slave units displays or via digital interface during remote control or remote supervision.
- All units in the MS system supervise their own values regarding overvoltage, overcurrent and overpower and in case of alarm they report the alarm to the master. In situations where the current is probably not balanced between the units, it can occur that one unit generates an OC alarm though the global OC limit of the MS system was not reached. The same can occur with the OP alarm.

3.7.2 Series connection

The device from series PSI 9000 WR 3U Slave are supposed to run in master-slave parallel operation. In case different kinds of operation are intended for a device and it is removed from the master-slave system, series connection of two or multiple units is possible, but with restrictions. For reasons of safety and keeping the insulation intact, following restrictions apply:



- Both, negative (DC-) and positive (DC+) output poles, are connected to PE via type X capacitors. Thus none of DC minus poles of units in series connection must have a potential against ground (PE) higher than specified in the technical specifications! The maximum allowed potential shift varies from model to model and is different for DC plus and DC minus
- The Share Bus must not be wired and used!
- Remote sensing must not be wired and used!
- Series connection is only allowed with models of same kind, i.e. power supply with power supply, and rating, but at least same current rating like for example PSI 9080-510 WR 3U Slave with PSI 9080-510 WR 3U Slave or PSI 9080-510 WR 3U or further suitable models of other series

Series connection in Master-Slave mode is not supported. It means, all units have to be controlled separately regarding set values and DC output status, which is only possible in remote control via one of the USB ports.

Due to the max. allowed potential shift on the DC output certain models are not allowed for series connection at all. Thus it's not permissible to connect two or three models with 1000 V rating in series, because their DC plus is only isolated up to 1800 V. On the contrary, two or three 500 V models are eligible for series connection.

3.7.3 Two quadrants operation (2QO)

3.7.3.1 Overview

The so-called two-quadrants operation, which is based on the source-sink principle, couples a power supply and an electronic load are via a control signal. It enables the automatic switchover between either the source or the sink being active. 2QO is also allowed for master-slave systems. A master-slave system built from power supplies is then considered as one big source and will be handled and controlled as such. The same configuration is doable with several electronic loads building a big sink. More information about setup, configuration and use of a 2QO system can be found in the user manuals of the power supply series PS/PSI/PSE 9000 and PSI 9000 WR, as well as of the electronic load series ELR 9000 or EL 9000 B.

For the operation of two master-slave system in 2QO, being connected via Share bus, the same restriction as with master-slave operation applies: the max. number of 16 units on the Share bus.

4. Service and maintenance

4.1 Maintenance / cleaning

The device needs no maintenance. Cleaning may be needed for the internal fans, the frequency of cleanse is depending on the ambient conditions. The fans serve to cool the components which are heated by the inherent power loss. Heavily dirt filled fans can lead to insufficient airflow and therefore the DC output would switch off too early due to overheating or possibly lead to defects.

Cleaning the internal fans can be performed with a vacuum cleaner or similar. For this the device needs to be opened.

4.2 Fault finding / diagnosis / repair

If the equipment suddenly performs in an unexpected way, which indicates a fault, or it has an obvious defect, this can't and must not be repaired by the user. Contact the supplier in case of suspicion and elicit the steps to be taken.

It will then usually be necessary to return the device to the supplier (with or without guarantee). If a return for checking or repair is to be carried out, ensure that:

- the supplier has been contacted and it is clarified how and where the equipment should be sent.
- the device is in fully assembled state and in suitable transport packaging, ideally the original packaging.
- a fault description in as much detail as possible is attached.
- if shipping destination is abroad, the necessary customs papers are attached.

4.2.1 Firmware update



Firmware updates should only be installed when they can eliminate existing bugs in the firmware in the device or contain new features.

The firmware of the control panel (HMI), of the communication unit (KE) and the digital controller (DR), if necessary, is updated via the rear side USB port. For this the software "EA Power Control" is needed which is included with the device or available as download from our website together with the firmware update, or upon request.

However, be advised not to install updates promptly. Every update includes the risk of an inoperable device or system.

We recommend to install updates only if...

- an imminent problem with your device can directly be solved, especially if we suggested to install an update during a support case
- a new feature has been added which you definitely want to use. In this case, the full responsibility is transferred to you.

Following also applies in connection with firmware updates:

- Simple changes in firmwares can have crucial effects on the application the devices are use in. We thus recommend to study the list of changes in the firmware history very thoroughly.
- Newly implemented features may require an updated documentation (user manual and/or programming guide, as well as LabView VIs), which is often delivered only later, sometimes significantly later

5. Contact and support

5.1 General

Repairs, if not otherwise arranged between supplier and customer, will be carried out by the manufacturer. For this the device must generally be returned to the manufacturer. No RMA number is needed. It is sufficient to package the equipment adequately and send it, together with a detailed description of the fault and, if still under guarantee, a copy of the invoice, to the following address.

5.2 Contact options

Questions or problems with operation of the device, use of optional components, with the documentation or software, can be addressed to technical support either by telephone or e-Mail.

Address	e-Mail	Telephone
EA Elektro-Automatik GmbH Helmholtzstr. 31-37 41747 Viersen Germany	Technical support: support@elektroautomatik.de All other issues: ea1974@elektroautomatik.de	Switchboard: +49 2162 / 37850 Support: +49 2162 / 378566



Elektro-Automatik

EA Elektro-Automatik GmbH & Co. KG
Development - Production - Sales

Helmholtzstraße 31-37
41747 Viersen
Germany

Fon: +49 2162 / 37 85-0
ea1974@elektroautomatik.de
www.elektroautomatik.com