



Elektro-Automatik



MANUAL

EA-PU 10000 6U

Programmable
DC Power Supply

TABLE OF CONTENTS

1. General		
1.1	About this document	4
1.1.1	Retention and use	4
1.1.2	Copyright	4
1.1.3	Validity	4
1.1.4	Symbols and warnings	4
1.2	Warranty	4
1.3	Limitation of liability	4
1.4	Disposal of equipment	5
1.5	Product key	5
1.6	Intended usage	6
1.6.1	Symbols and warnings on the device	6
1.7	Safety	7
1.7.1	Safety notices	7
1.7.2	Responsibility of the operator	8
1.7.3	Requirements to the user	8
1.7.4	Responsibility of the user	8
1.7.5	Alarm signals	9
1.7.6	Functionality test	9
1.8	Technical data	10
1.8.1	Approved operating conditions	10
1.8.2	General technical data	10
1.8.3	Specific technical data	11
1.8.4	Views	14
1.8.5	Control elements	17
1.9	Construction and function	18
1.9.1	General description	18
1.9.2	Block diagram	18
1.9.3	Scope of delivery	19
1.9.4	Accessories	19
1.9.5	Options	19
1.9.6	The control panel (HMI)	20
1.9.7	USB port (rear side)	21
1.9.8	Interface module slot	21
1.9.9	Analog interface	22
1.9.10	“Share-Bus” connector	22
1.9.11	“Sense” connector (remote sensing)	22
1.9.12	Master-Slave bus	23
1.9.13	Ethernet port	23
1.9.14	Water cooling	23
2. Installation & commissioning		
2.1	Transport and storage	24
2.1.1	Transport	24
2.1.2	Packaging	24
2.1.3	Storage	24
2.2	Unpacking and visual check	24
2.3	Installation	24
2.3.1	Safety procedures before installation and use	24
2.3.2	Preparation	24
2.3.3	Installing the device	26
2.3.4	Installing the water cooling	27
2.3.5	Connection to AC supply	29
2.3.6	Connection to DC loads	31
2.3.7	Grounding of the DC terminal	32
2.3.8	Connection of remote sense	32
2.3.9	Installation of an interface module	33
2.3.10	Connecting the analog interface	34
2.3.11	Connecting the share bus	34
2.3.12	Connecting the USB ports	34
2.3.13	Initial commission	34
2.3.14	Commission after a firmware update or a long period of non-use	34
3. Operation and application		
3.1	Personal safety	35
3.2	Operating modes	35
3.2.1	Voltage regulation / Constant voltage	35
3.2.2	Current regulation / constant current / current limiting	36
3.2.3	Power regulation / constant power / power limiting	36
3.2.4	Internal resistance regulation	36
3.3	Alarm conditions	37
3.3.1	Power Fail	37
3.3.2	Overtemperature	37
3.3.3	Overvoltage protection	37
3.3.4	Overcurrent protection	37
3.3.5	Overpower protection	37
3.3.6	Share bus fail	38
3.4	Manual operation	39
3.4.1	Powering the device	39
3.4.2	Switching the device off	39
3.4.3	Switching the DC output on or off	39
3.5	Remote control	40
3.5.1	General	40
3.5.2	Remote control via digital interface	40
3.5.3	Interface monitoring	41
3.5.4	Remote control via the analog interface	42
3.6	Device alarm handling	46
3.7	Other applications	47
3.7.1	Parallel operation in master-slave (MS)	47
3.7.2	Series connection	51
3.7.3	SEMI F47	51

4.	Service and maintenance	
4.1	Maintenance / cleaning	52
4.1.1	Battery replacement	52
4.2	Fault finding / diagnosis / repair	52
4.2.1	Firmware updates	52
4.2.2	Trouble-shooting device problems	53
5.	Contact and support	
5.1	Repairs/Technical support	54
5.2	Contact options	54

Attention! The part of this document that deals with the handling of features on the control panel is only valid for devices with firmwares "KE: 3.06", "HMI: 2.05" and "DR: 1.0.2.20" or higher.

1. General

1.1 About this document

1.1.1 Retention and use

This document is to be kept in the vicinity of the equipment for future reference and explanation of the operation of the device. This document is to be delivered and kept with the equipment in case of change of location and/or user.

The most recent issue of this document can be found online, on our website.

1.1.2 Copyright

Reprinting, copying, also partially, usage for other purposes as foreseen of this manual are forbidden and breach may lead to legal consequences.





1.1.3 Validity

This manual is valid for the following equipment including derived variants:

Model	Model
EA-PU 10360-480 6U	EA-PU 11000-160 6U
EA-PU 10500-360 6U	EA-PU 11500-120 6U
EA-PU 10750-240 6U	EA-PU 12000-80 6U
EA-PU 10920-250 6U	

1.1.4 Symbols and warnings

Warning and safety notices as well as general notices in this document are shown in a box with a symbol as follows:

	Symbol for a life threatening danger (electric shock hazard)
	Symbol for risk (of damage to the equipment). If placed on the device it requests the user to read the operating guide prior to start operation.
	Symbol for general safety notices (instructions and damage protection bans) or important information for operation
	<i>Symbol for general notices</i>

1.2 Warranty

EA Elektro-Automatik guarantees the functional competence of the applied technology and the stated performance parameters. The warranty period begins with the delivery of free from defects equipment.

Terms of guarantee are included in the general terms and conditions of EA Elektro-Automatik.

1.3 Limitation of liability

All statements and instructions in this manual are based on current norms and regulations, up-to-date technology and our long term knowledge and experience. The manufacturer accepts no liability for losses due to:

- Usage for purposes other than designed
- Use by untrained personnel
- Rebuilding by the customer
- Technical changes
- Use of not authorized spare parts

The actual delivered device(s) may differ from the explanations and diagrams given here due to latest technical changes or due to customized models with the inclusion of additionally ordered options.

1.4 Disposal of equipment

A piece of equipment which is intended for disposal must, according to European laws and regulations (ElektroG, WEEE) be returned to the manufacturer for scrapping, unless the person operating the piece of equipment or another, delegated person is conducting the disposal. Our equipment falls under these regulations and is accordingly marked with the following symbol:



The device contains a Lithium battery cell. Disposal of that battery follows the above stated rule or specific local regulations.

1.5 Product key

Decoding of the product description on the label, using an example:

EA-PU 10 360 - 480 6U zzz

	Field for identification of installed options: WC = Water cooling installed
	Construction (only stated on type label): 6U = 19" frame with 4U
	Maximum current of the device in Ampere
	Maximum voltage of the device in Volt („10360“ = 360 Volt)
	Series: 10 = Series 10000
	Type identification: PU = Power Unit

1.6 Intended usage





The equipment is intended to be used only as a variable voltage and current source or only as a variable current sink. Furthermore it's only intended to be used installed and operated in suitable equipment (19" rack or similar), together with a rigid, non-retractable AC supply connection.

Typical application for a voltage source is the DC power supply to any relevant consumer, including when used as battery charger to test charge various battery types, and for current sinks the replacement of an ohmic resistor by an adjustable electronic DC load in order to load relevant voltage and current sources of any type.



- Claims of any sort due to damage caused by non-intended usage will not be accepted.
- All damage caused by non-intended usage is solely the responsibility of the operator.

1.6.1 Symbols and warnings on the device

Decal	Explanation
 <div data-bbox="276 629 539 819"> <p>! DANGER RISK OF ELECTRIC SHOCK Disconnect all sources of supply prior to servicing.</p> </div>	<p>This warning is primarily related to the reconfiguration of the device on the DC terminal which, for safety reasons, requires to also cut the device from AC (external main switch). The same applies to disconnection and reconnection of the AC terminal.</p>
 <div data-bbox="276 860 539 1050"> <p>! DANGER Capacitors on DC, storing voltage! Discharge for 10 sec then ground before working.</p> </div>	<p>Even after disconnection of the DC terminal from an external source there can still be dangerous voltage potential present between the DC terminal poles and/or between DC and the enclosure. For safety reasons the DC terminal must be short-circuited after the capacitors have been discharged and it must also be grounded, i. e. connected to PE.</p>
 <div data-bbox="276 1084 539 1274"> <p>! WARNING ELECTRICAL HAZARDS Authorized personnel only.</p> </div>	<p>There can always be a voltage potential on metallic, openly touchable parts on electrical devices, though the voltage level may not be hazardous. Caution is still advisable, as these potential can still cause mild electrical shocks or sparking.</p>
 <div data-bbox="276 1308 539 1498"> <p>! WARNING Read and understand the operating guide before using this device. Non-adherence of the instructions in the operating guide can result in serious injury or death.</p> </div>	<p>This is valid for any use of the device.</p>

Mortal danger - Hazardous voltage



- Electrical equipment operation means that some parts accessible on the outside of the device can be under high voltage. Therefore all parts under voltage must be covered during operation!
- The DC terminal is isolated from the AC input and not connected to ground internally. Hence there can be dangerous potential between the DC poles and PE, for instance caused by a connected external source application. Due to charged capacitors this could even be true if the DC output or the device are already switched off.
- Air-cooled models: Do not insert any object, particularly metallic, through the ventilation slots!
- For every reconfiguration on the AC or DC terminals, specifically those which can have a dangerous voltage potential, the device must be cut completely from the AC supply (main switch on the distant end of the AC cable); it doesn't suffice to only use the power switch on the front
- Always follow 5 safety rules when working with electric devices:
 - Disconnect completely
 - Secure against reconnection
 - Verify that the system is dead
 - Carry out earthing and short-circuiting
 - Provide protection from adjacent live parts



- Avoid any use of liquids near the equipment. Protect the device from wet, damp and condensation.
- Do not connect external power sources with reversed polarity to the DC terminal! The equipment will be damaged, even when completely powered off.
- Never connect external power sources to the DC terminal that can generate a higher voltage than the rated voltage of the device!
- Never insert a network cable which is connected to Ethernet or its components into the master-slave sockets on the rear side of the device!



- The equipment must only be used as intended
- The equipment is only approved for use within the connection limits stated on the product label.
- ESD regulations must be applied when plugging interface cards or modules into the relative slot
- Interface cards or modules may only be attached or removed after the device is switched off. It's not necessary to open the device.
- Always configure the various protecting features against overcurrent, overvoltage etc. for sensitive loads to what the target application requires!
- The equipment isn't meant to be operated in private facilities, because it can't sufficiently prevent to interfere with local radio reception (mobile phones, TV etc.)

1.7.2 Responsibility of the operator

Operator is any natural or legal person who uses the equipment or delegates the usage to a third party, and is responsible during its usage for the safety of the user, other personnel or third parties.

The equipment is in industrial operation. Therefore the operators are governed by the legal safety regulations. Alongside the warning and safety notices in this manual the relevant safety, accident prevention and environmental regulations must also be applied. In particular the operator has to

- be acquainted with the relevant job safety requirements
- identify other possible dangers arising from the specific usage conditions at the work station via a risk assessment
- introduce the necessary steps in the operating procedures for the local conditions
- regularly control that the operating procedures are current
- update the operating procedures where necessary to reflect changes in regulation, standards or operating conditions.
- define clearly and unambiguously the responsibilities for operation, maintenance and cleaning of the equipment.
- ensure that all employees who use the equipment have read and understood the manual. Furthermore the users are to be regularly schooled in working with the equipment and the possible dangers.
- provide all personnel who work with the equipment with the designated and recommended safety equipment

Furthermore, the operator is responsible for ensuring that the device is at all times technically fit for use.

1.7.3 Requirements to the user

Any activity with equipment of this type may only be performed by persons who are able to work correctly and reliably and satisfy the requirements of the job.

- Persons whose reaction capability is negatively influenced by e.g. drugs, alcohol or medication may not operate the equipment.
- Age or job related regulations valid at the operating site must always be applied.



Danger for unqualified users

Improper operation can cause person or object damage. Only persons who have the necessary training, knowledge and experience may use the equipment.

The group of people allowed to operate the equipment is additionally limited to:

Delegated persons: these are persons who have been properly and demonstrably instructed in their tasks and the attendant dangers.

Qualified persons: these are persons who are able through training, knowledge and experience as well as knowledge of the specific details to carry out all the required tasks, identify dangers and avoid personal and other risks.

1.7.4 Responsibility of the user

The equipment is in industrial operation. Therefore the operators are governed by the legal safety regulations. Alongside the warning and safety notices in this manual the relevant safety, accident prevention and environmental regulations must also be applied. In particular the users of the equipment:

- must be informed of the relevant job safety requirements
- must work to the defined responsibilities for operation, maintenance and cleaning of the equipment
- before starting work must have read and understood the operating manual
- must use the designated and recommended safety equipment.

Furthermore, anyone working with the equipment is responsible for ensuring that the device is at all times technically fit for use.

1.7.5 Alarm signals

The equipment offers various possibilities for signaling alarm conditions, however, not for danger situations. The signals are optical (via an LED on the control panel) or electronically (status output of the analog interface) and digitally readable status bits. All alarms will cause the device to switch off the DC output. For details about the different alarms refer to section «3.3 Alarm conditions».

The meaning of the signals is as follows:

Signal OT (OverTemperature)	<ul style="list-style-type: none"> • Overheating of the device • DC output will be switched off • Non-critical
Signal OVP (OverVoltage)	<ul style="list-style-type: none"> • Overvoltage shutdown of the DC output due to excess of the preset limit • Critical! The device and/or the load could be damaged
Signal OC (OverCurrent)	<ul style="list-style-type: none"> • Shutdown of the DC output due to excess of the preset limit • Non-critical, protects the load from excessive current consumption
Signal OPP (OverPower)	<ul style="list-style-type: none"> • Shutdown of the DC output due to excess of the preset limit • Non-critical, protects the load from excessive power consumption
Signal PF (Power Fail)	<ul style="list-style-type: none"> • DC output shutdown due to AC undervoltage or defect in the AC input • Critical on overvoltage! AC input circuit could be damaged
Signal MSP (Master-Slave Protection)	<ul style="list-style-type: none"> • DC output shutdown due to communication problems on the master-slave bus • Non-critical
Signal SF (Share Bus Fail)	<ul style="list-style-type: none"> • DC output shutdown due to signal distortion on the share bus • Non-critical

1.7.6 Functionality test

The operator of the device must decide when to check the device for correct functionality, by whom and how often. The “when” could either be before every use or after it has been relocated or reconfigured or perhaps in a defined interval.



Should the set values not be adjustable as instructed below it could simply be due to adjustment limits interfering. When reaching a limit adjusting value can't be signaled by the device. In remote control an invalid value would be rejected, together with an error message.

The test procedure would always be like this:

1. Disconnect all cables (DC, Sense, share bus, analog interface, USB), except for AC.
2. Connect a suitable voltage meter to the DC terminal.
3. Switch the device on, adjust a voltage of 10% U_{Nom} using remote control via the front or rear USB port while the current and power set values all should be at maximum. Then switch the DC output on and verify with the multimeter that the adjusted voltage is available on the DC terminal. Also compare it to the actual voltage value read via remote command query.
4. Repeat the same thing at 100% U_{Nom} .
5. Switch the DC output off and bridge the DC terminal with a cable or copper rails of suitable current capability of at least I_{Nom} . If available, put a current measuring device (transducer, current probe).
6. Adjust the current set value to 10% I_{Nom} , switch the DC output on and measure the current with the external measuring device, if available, and compare to the actual current measured by the device which can be read via remote query command or at least compare the read actual current with the set value.
7. Repeat the same thing at 100% I_{Nom} .

Only if the current and voltage are supplied by the device as adjustable in the range of 0-100% FS, the device can be considered as fully operational.

1.8 Technical data

1.8.1 Approved operating conditions

1.8.1.1 Ambiance

The allowed ambient temperature range for operation is 0 °C (32 °F) to 50 °C (122 °F). During storage or transport, the allowed range extends to -20 °C (-4 °F) to 70 °C (158 °F). In case water condensation occurred due to transport, the device must be acclimatized prior to operation for at least 2 hours, ideally in a place with good air circulation.

The device is intended to be operation in dry rooms. It must not be exposed or operated to extreme dust, high air humidity, danger of explosion and aggressive chemicals polluting the air. The operating position isn't arbitrary (see «2.3.3 Installing the device»),but in any case it requires a sufficient air circulation. The device is allowed to be operated in altitude up to 2000 m (approx. 6,560 ft) above sea level. Technical specifications (here: ratings), when given with tolerance, are valid for a unit warmed up for at least 30 minutes and for an ambient temperature of 23 °C (73 °F). Specifications without tolerance are typical values from an average device.

1.8.1.2 Cooling

Power dissipated inside the device heats up air flowing through the device. With air-cooled models, entry is on the front and exhaust at the back. Depending on the internal temperature, the fan speed is automatically regulated up or down, whereas a certain minimum speed is maintained because some internal components even heat up when the device is idle.

Dust in the air can obstruct the air flow with time, thus it's important to keep the air flow unimpeded at least outside of the device be leaving sufficient room behind it. Since it's usually installed inside cabinets, the cabinet doors are required to be meshed.

At the same time, the ambient temperature should be kept at low levels, perhaps by external means such as an air condition. Should the device heat up internally and the cooling block temperature exceed 80 °C (160 °F), the device will protect itself from overheating by automatically switching off the DC output. It could then only continue to operate and switch the DC output on again after cooling down for some time.

For the water-cooled versions, water is the main cooling agent, flowing through the internal cooling blocks. The air inside the almost hermetically body circulates, engaged by fans, to cool the remaining components not sitting on the cooling blocks, but heat up over time.

1.8.2 General technical data

Display: 6 LED with different colors

Controls: 1 pushbutton

1.8.3 Specific technical data

General specifications	
AC input	
Voltage, Phases	380 V - 480 V \pm 10%, 3ph AC
Frequency	45 - 65 Hz
Power factor	ca. 0.99
Leakage current	<10 mA
Phase current	\leq 110 A @ 400 V AC
Overvoltage category	3
DC output static	
Load regulation CV	\leq 0.05% FS (0 - 100% load, constant AC input voltage and constant temperature)
Line regulation CV	\leq 0.01% FS (380 V - 480 V \pm 10% AC input voltage, constant load and constant temperature)
Stability CV	\leq 0.02% FS (during 8 h of operation, after 30 minutes warm-up, at constant AC input voltage, load and temperature)
Temperature coefficient CV	\leq 30ppm/ $^{\circ}$ C (after 30 minutes of warm-up)
Compensation (remote sense)	\leq 5% $U_{Nominal}$
Load regulation CC	\leq 0.1% FS (0 - 100% load, constant AC input voltage and constant temperature)
Line regulation CC	\leq 0.01% FS (380 V - 480 V \pm 10% AC input voltage, constant load and constant temperature)
Stability CC	\leq 0.02% FS (during 8 h of operation, after 30 minutes warm-up, at constant AC input voltage, load and temperature)
Temperature coefficient CC	\leq 50ppm/ $^{\circ}$ C (after 30 minutes of warm-up)
Load regulation CP	\leq 0.3% FS (0 - 100% load, constant AC input voltage and constant temperature)
Load regulation CR	\leq 0.3% FS + 0.1% FS current (0 - 100% load, constant AC input voltage and constant temperature)
Protective functions	
OVP	Overvoltage protection, adjustable 0 - 110% $U_{Nominal}$
OCP	Overcurrent protection, adjustable 0 - 110% $I_{Nominal}$
OPP	Overpower protection, adjustable 0 - 110% $P_{Nominal}$
OT	Overtemperature protection (DC output shuts down in case of insufficient cooling)
DC output dynamic	
Rise time 10 - 90% CV	\leq 10 ms
Fall time 90 - 10% CV	\leq 10 ms
Rise time 10 - 90% CC	\leq 2 ms
Fall time 90 - 10% CC	\leq 2 ms
Insulation	
AC input to DC output	3750 Vrms (1 minute, creepage distance >8 mm)
AC input to case (PE)	2500 Vrms
DC output to case (PE)	Depending on the model, see model tables
DC output to interfaces	1000 V DC (models up to 360 V output), 1500 V DC (models from 500 V output)
Interfaces digital	
Built-in, galvanically isolated	USB, Ethernet (100 MBit), USB front panel, all for communication
Optional, galvanically isolated	CAN, CANopen, RS232, ModBus TCP, Profinet, Profibus, EtherCAT, Ethernet
Interfaces analog	
Built-in, galvanically isolated	15 pole D-Sub
Signal range	0 - 10 V or 0 - 5 V (switchable)
Inputs	U, I, P, R, remote control on/off, DC output on/off, resistance mode on/off
Outputs	Monitor U and I, alarms, reference voltage, DC output status, CV/CC regulation mode
Accuracy U / I / P / R	0 - 10 V: \leq 0.2%, 0 - 5 V: \leq 0.4%
Device configuration	
Parallel operation	Up to 64 units of any power class in series 10000 starting from 5 kW, with Master-Slave bus and Share-Bus

General specifications	
Safety and EMC	
Safety	EN 61010-1 IEC 61010-1 UL 61010-1 CSA C22.2 No 61010-1 BS EN 61010-1
EMC	EN 55011, class A, group 1 CISPR 11, class A, group 1 FCC 47 CFR part 15B, unintentional radiator, class A EN 61326-1 include tests according to: - EN 61000-4-2 - EN 61000-4-3 - EN 61000-4-4 - EN 61000-4-5 - EN 61000-4-6
Safety protection class	1
Ingress Protection	IP20
Environmental conditions	
Operating temperature	0 - 50 °C (32 - 122 °F)
Storage temperature	-20 - 70 °C (-4 - 158 °F)
Humidity	≤80% relative humidity, non-condensing
Altitude	≤2000 m (≤6,600 ft)
Pollution degree	2
Mechanical construction	
Cooling	Forced air flow from front to rear (temperature controlled fans), optional: water cooling
Dimensions (W x H x D)	Enclosure: 19" x 6U x 668 mm (26.3 in)
Weight	76 kg (168 lb)
Weight with water cooling	82 kg (180 lb)

Technical specifications	PU 10360-480	PU 10500-360	PU 10750-240	PU 10920-250
DC output				
Voltage range	0 - 360 V	0 - 500 V	0 - 750 V	0 - 920 V
Ripple in CV (rms)	≤55 mV (BWL 300 kHz)	≤70 mV (BWL 300 kHz)	≤200 mV (BWL 300 kHz)	≤250 mV (BWL 300 kHz)
Ripple in CV (pp)	≤320 mV (BWL 20 MHz)	≤350 mV (BWL 20 MHz)	≤800 mV (BWL 20 MHz)	≤1200 mV (BWL 20 MHz)
Current range	0 - 480 A	0 - 360 A	0 - 240 A	0 - 250 A
Power range	0 - 60000 W	0 - 60000 W	0 - 60000 W	0 - 60000 W
Resistance range	0.025 Ω - 45 Ω	0.04 Ω - 85 Ω	0.1 Ω - 185 Ω	0.125 Ω - 275 Ω
Output capacitance	3480 μF	1560 μF	765 μF	465 μF
Efficiency sink/source (up to)	95.8% *1	96.5% *1	96.5% *1	96.5% *1
Insulation				
Negative DC pole <-> PE	±1000 V DC	±1500 V DC	±1500 V DC	±1500 V DC
Positive DC pole <-> PE	+1000 V DC	+2000 V DC	+2000 V DC	+2000 V DC
Article numbers				
Standard	01113010	01113011	01113012	01113013
Standard + Water Cooling	01463001	01463002	01463003	01463004

*1 At 100% power and 100% output voltage
 BWLL = band width limit

Technical specifications	PU 11000-160	PU 11500-120	PU 12000-80	
DC output				
Voltage range	0 - 1000 V	0 - 1500 V	0 - 2000 V	
Ripple in CV (rms)	≤300 mV (BWL 300 kHz)	≤400 mV (BWL 300 kHz)	≤500 mV (BWL 300 kHz)	
Ripple in CV (pp)	≤1600 mV (BWL 20 MHz)	≤2400 mV (BWL 20 MHz)	≤3000 mV (BWL 20 MHz)	
Current range	0 - 160 A	0 - 120 A	0 - 80 A	
Power range	0 - 60000 W	0 - 60000 W	0 - 60000 W	
Resistance range	0.2 Ω - 325 Ω	0.4 Ω - 750 Ω	0.85 Ω - 1350 Ω	
Output capacitance	387 μF	173 μF	85 μF	
Efficiency sink/source (up to)	95.8% *1	96.5% *1	96.5% *1	
Insulation				
Negative DC pole <-> PE	±1500 V DC	±1500 V DC	±1500 V DC	
Positive DC pole <-> PE	+2000 V DC	+2000 V DC	+2000 V DC	
Article numbers				
Standard	01113014	01113015	01113016	
Standard + Water Cooling	01463005	01463006	01463007	

*1 At 100% power and 100% output voltage
 BWLL = band width limit

1.8.4 Views
 1.8.4.1 Technical drawings PU 10000 6U

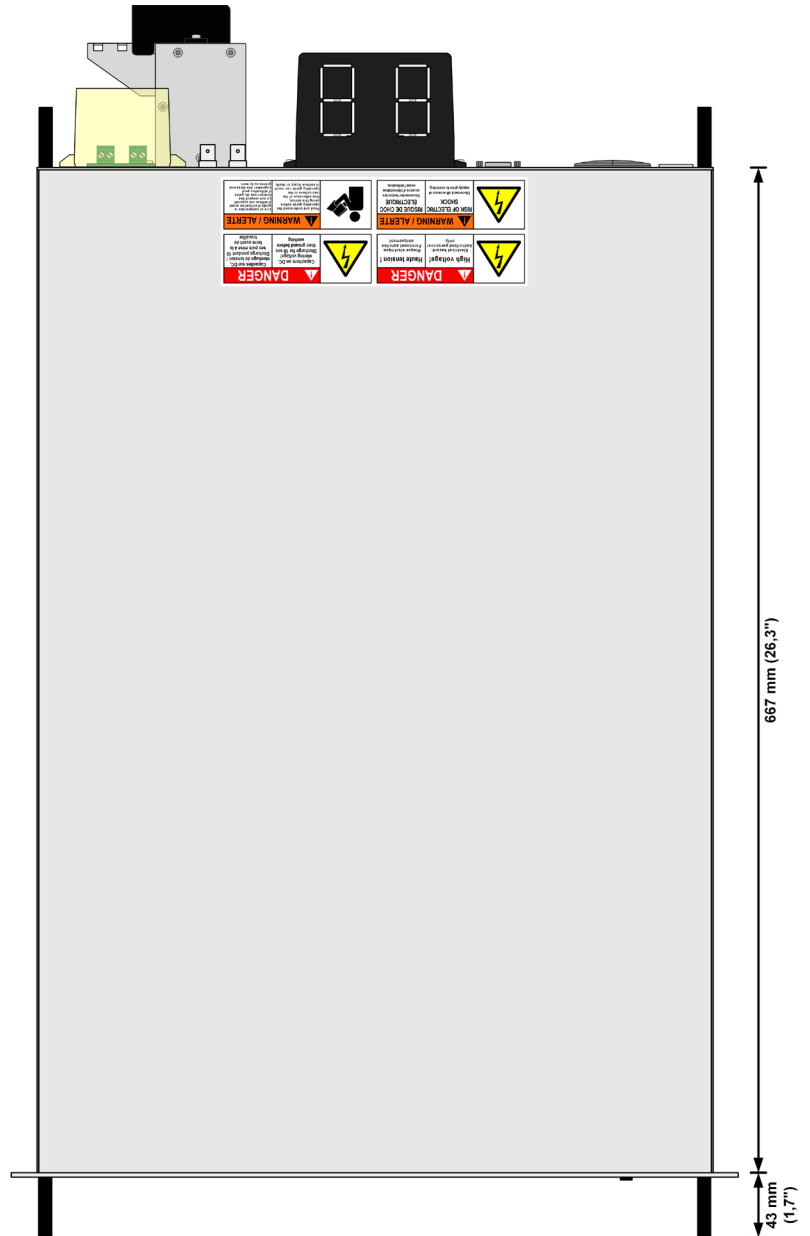
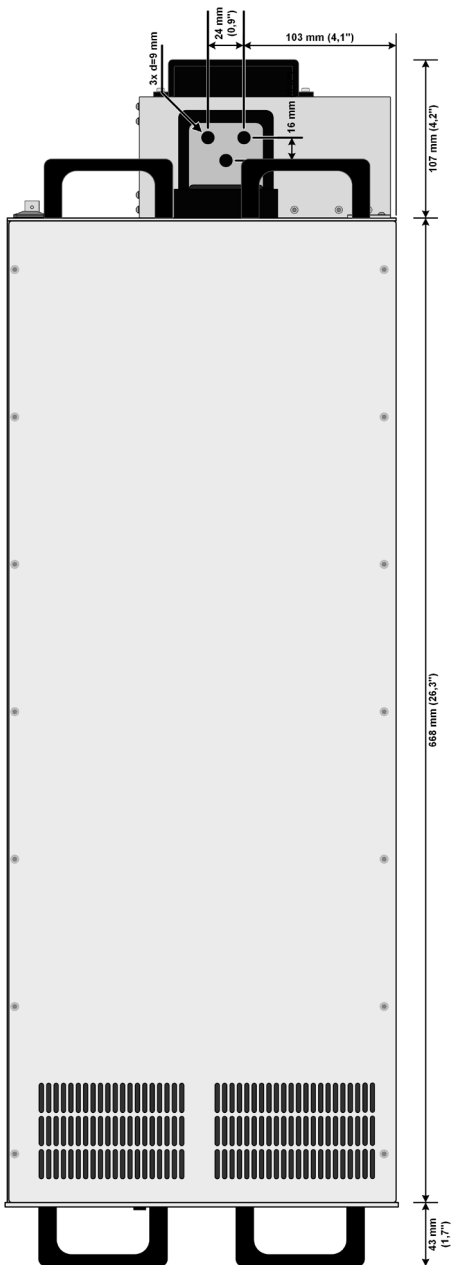
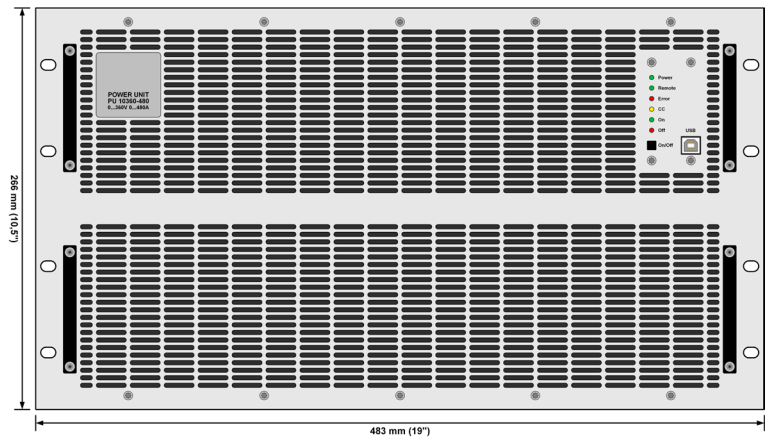

Side view of the air-cooled version shown

1.8.4.2 Front panel description PU 10000 6U

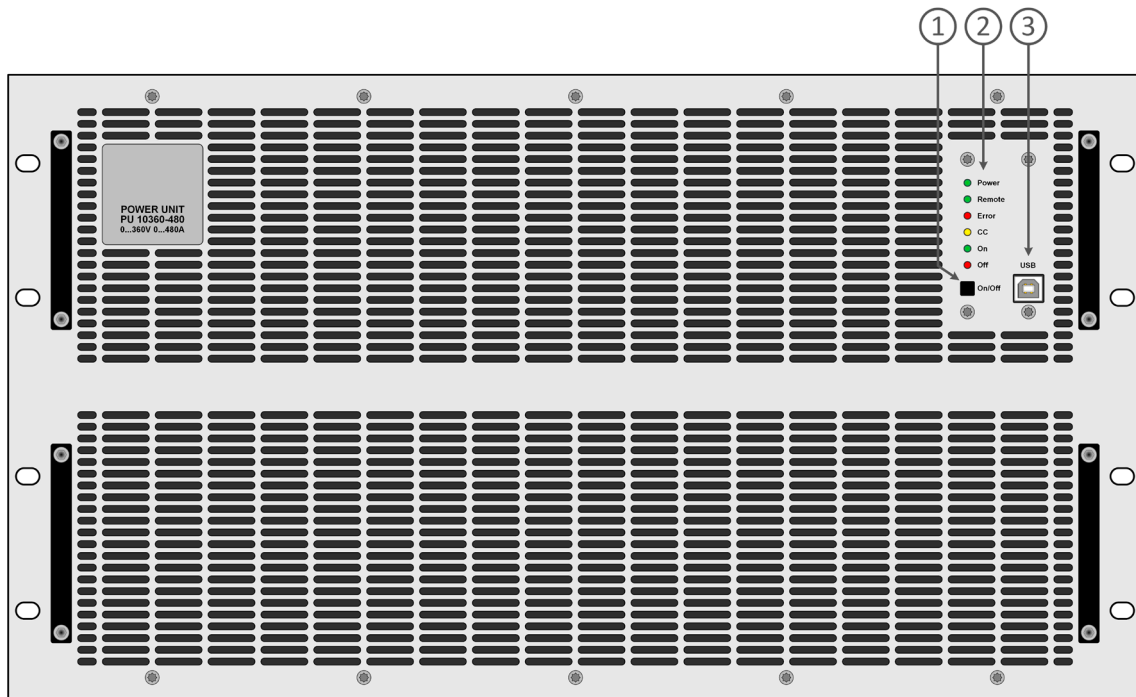

1. DC on/off pushbutton
2. LED status display
3. USB interface

1.8.4.3 Rear panel description PU 10000 6U

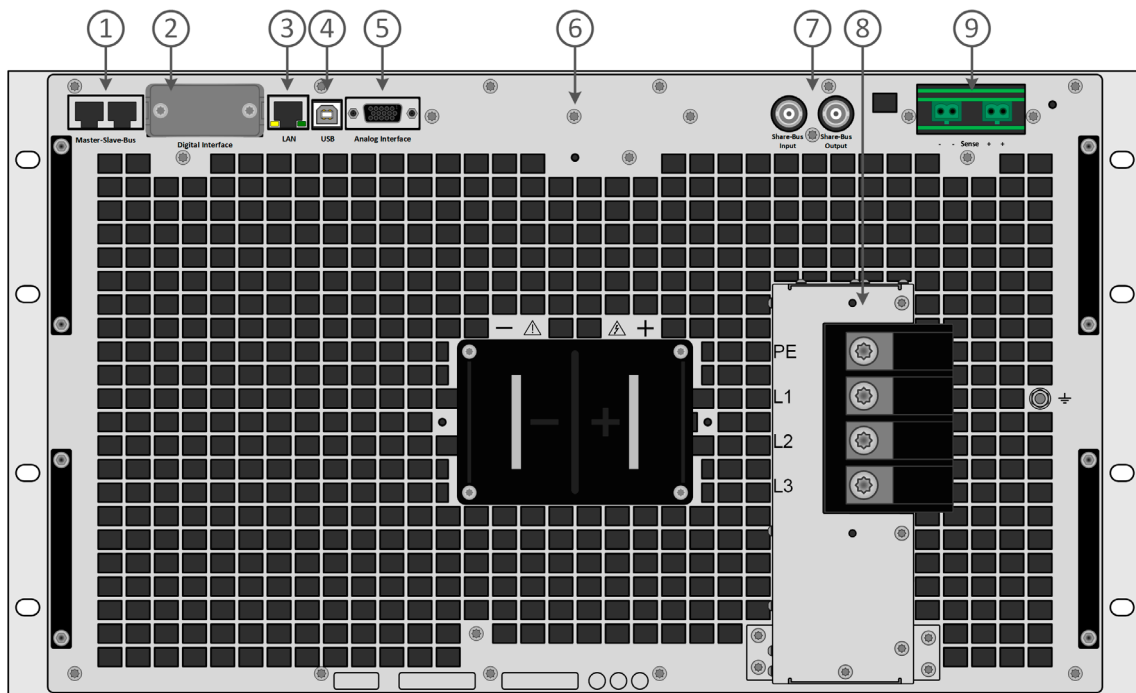

1. Master-Slave bus connectors to set up a system for parallel connection
2. Slot for optional interfaces
3. Ethernet interface
4. USB interface
5. Connector (DB15 female) for isolated analog programming, monitoring and other functions
6. DC output terminal (copper blades)
7. Share bus connectors to set up a system for parallel connection
8. AC input connector
9. Remote sense connectors

1.8.4.4 Front panel description PU 10000 6U WC (water cooling option)

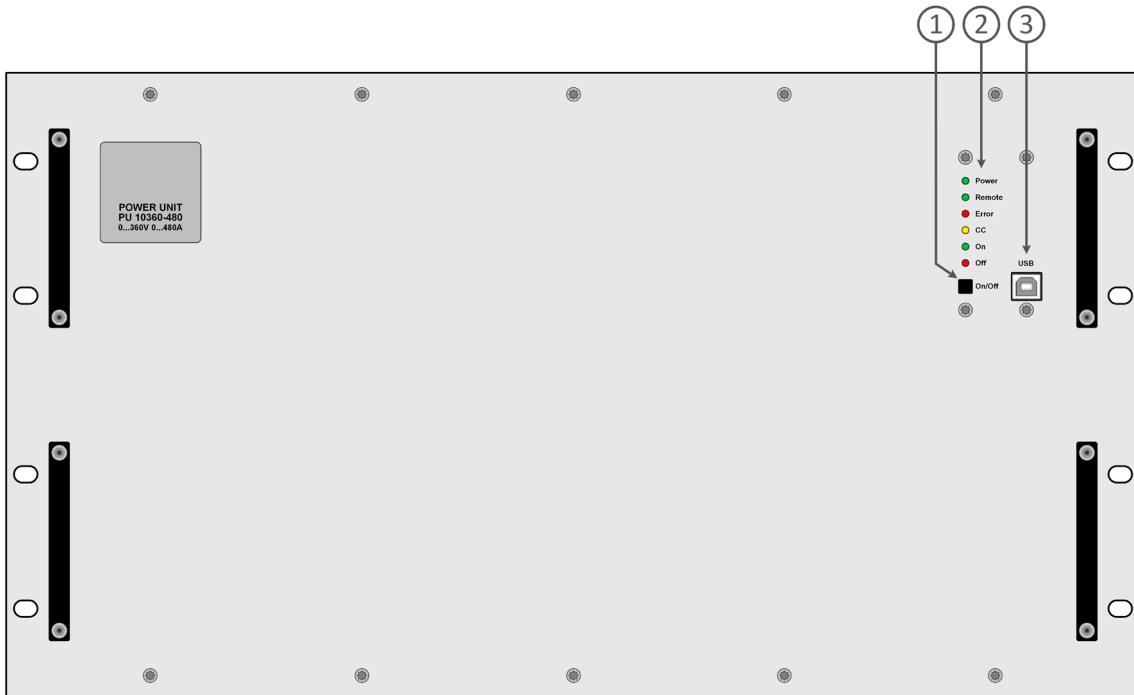

1. DC on/off pushbutton
2. LED status display
3. USB interface

1.8.4.5 Rear panel description PU 10000 6U WC (water cooling option)

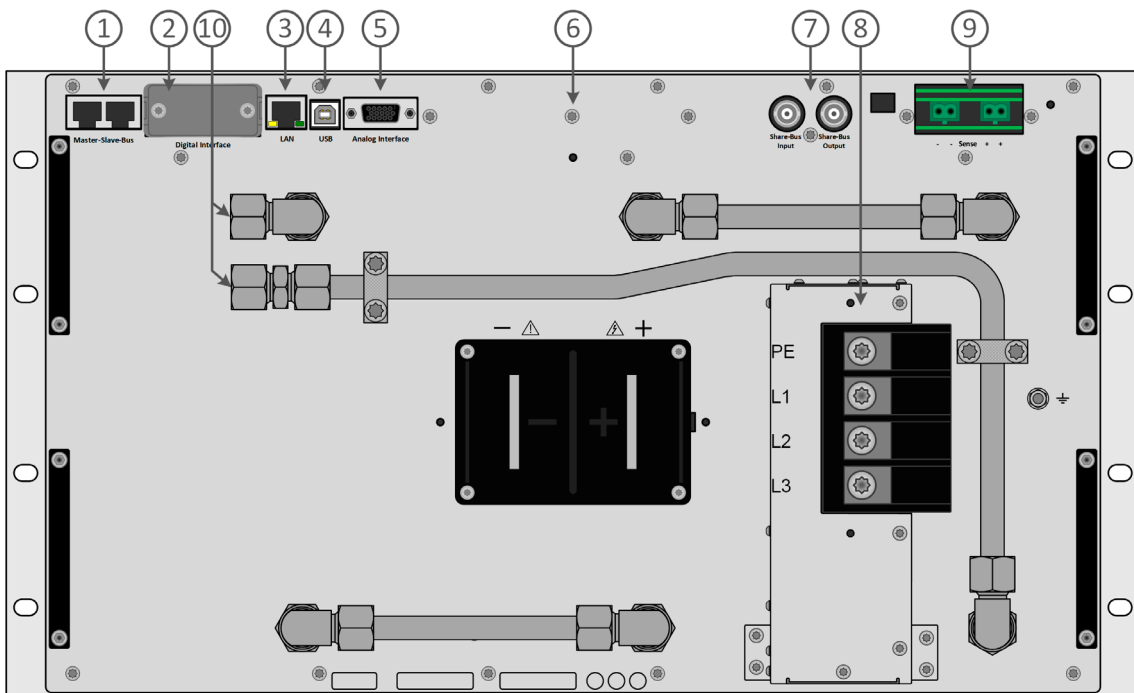

1. Master-Slave bus connectors to set up a system for parallel connection
2. Slot for optional interfaces
3. Ethernet interface
4. USB interface
5. Connector (DB15 female) for isolated analog programming, monitoring and other functions
6. DC output terminal (copper blades)
7. Share bus connectors to set up a system for parallel connection
8. AC input connector
9. Remote sense connectors
10. Water inlet and outlet

1.8.5 Control elements

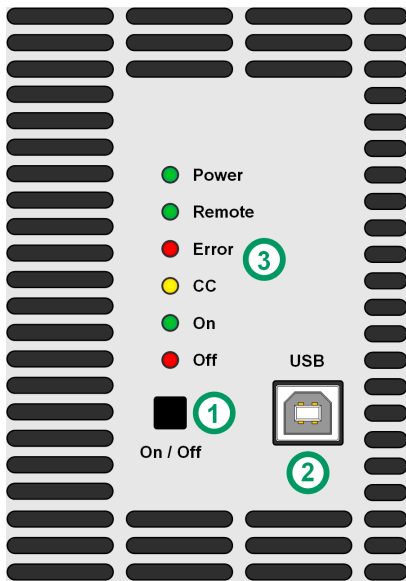



Figure 1 - Control Panel

Overview of the elements on the control panel

For a detailed description see section «1.9.6 The control panel (HMI)».

(1)	<p>On/Off button</p> <p>Can be used to switch the DC output on or off during manual operation, while LED "Remote" is off</p> <div style="border: 1px solid black; padding: 5px; margin-top: 10px;">  <p><i>Pin REM-SB on the analog interface, when set to a logical level which would request to turn DC off, can block switching DC on by this pushbutton.</i></p> </div>
(2)	<p>USB port</p> <p>For quick and easy access to the most important DC output related values when the device isn't in master-slave mode. This port has reduced functionality compared to the rear port.</p>
(3)	<p>Status indicators (LED)</p> <p>These six color LEDs show the device status.</p>

1.9 Construction and function

1.9.1 General description

The devices in series PU 10000 6U represent matching models to series PS 10000 4U or PSI 10000 4U. They serve as extension modules, so called power units, which are intended to build master-slave systems with higher total power. Devices from series PSI 10000 4U or PS 10000 4U, which both have a color touch display, can serve as master unit, but all PU 10000 6U can also serve as master for other 10000 series power supplies should the control be solely remote.

For remote control the devices are provided as standard with USB and Ethernet ports on the rear side, as well as a galvanically isolated analog interface. Via optional plug-in interface modules, another digital interface such as for RS232, Profibus, ProfiNet, ModBus TCP, CAN, CANopen or EtherCAT can be added. These enable the devices to be connected to standard industrial buses simply by changing or adding a small module.

Alternatively to the standard air-cooled version there are also water-cooled available which are usually configured and offered in cabinet systems with a complete water cooling distribution inside. For DIY water-cooled systems single units can also be obtained upon request.

1.9.2 Block diagram

The block diagram illustrates the main components inside the device and their relationships.

There are digital, microprocessor controlled components (KE, DR, HMI), which can be target of firmware updates.

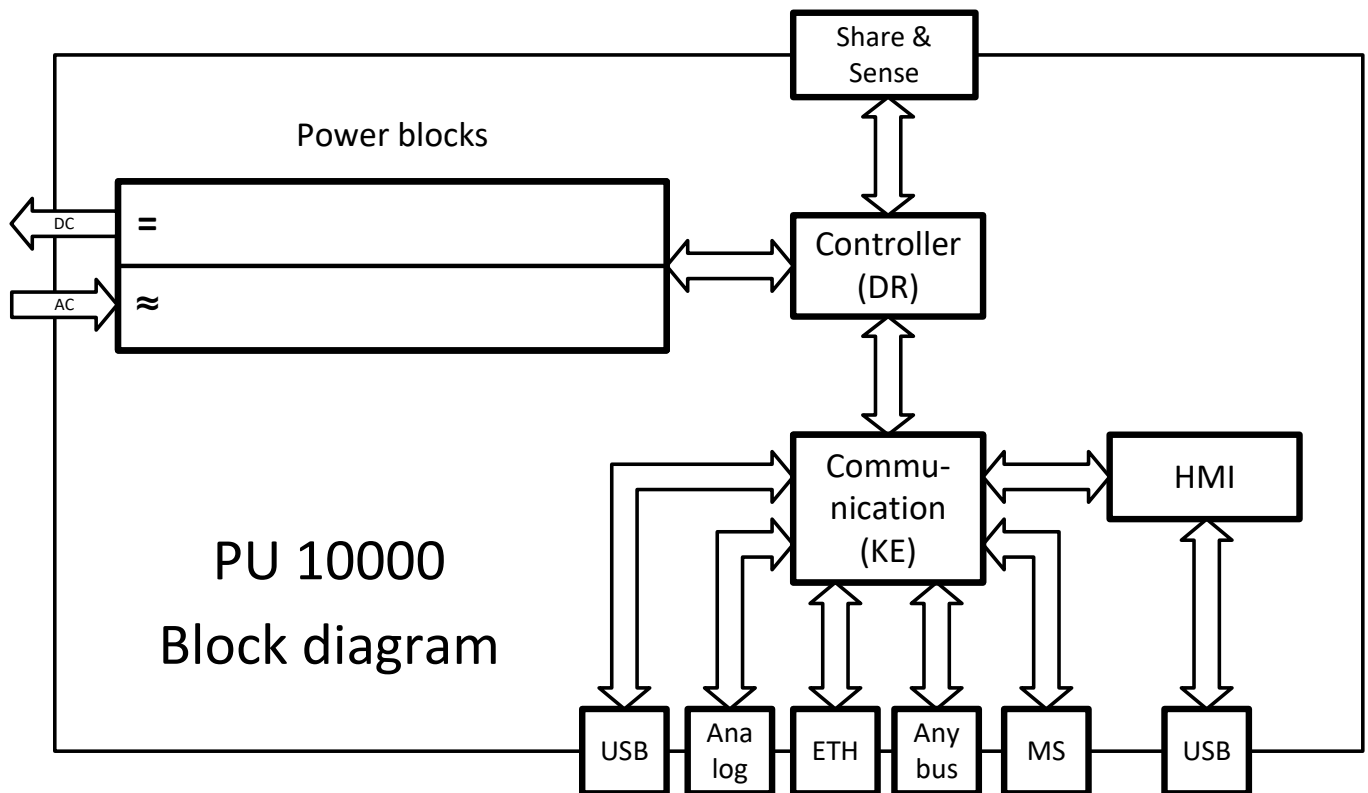

1.9.3 Scope of delivery

- 1 x Power supply device
- 2 x Remote sensing plugs
- 1 x 1.8 m (5.9 ft) USB cable
- 1 x DC terminal cover
- 1 x Sense terminal cover
- 1 x USB stick with documentation and software
- 1 x AC terminal cover
- 1 x Set for AC cable strain relief (bracket & cable ties)

1.9.4 Accessories

For these devices the following accessories are available:

IF-AB Digital interface modules	Pluggable and retrofittable digital interface modules for RS232, CANopen, Profibus, ProfiNet, ModBus TCP, EtherCAT or CAN are available. Details about the interface modules and the programming of the device using those interfaces can be found in separate documentation. It's usually available on the USB stick which is included with the device, or as PDF download on our website.
LIZENZFG Function generator license	This license upgrades the device with a full function generator as available with series PSI 10000. It's installed through a firmware update which is typically delivered by e-mail to the customer after the purchase, along with documentation (ModBus register list as reference) and further
LICENSE Software licenses	<p>All devices of this series are shipped with a free remote control software for Windows, called EA Power Control. Besides free-to-use apps this software has other apps like Multi Control, the Graph and the Function Generator, which can be unlocked with a purchasable license code. These three apps are combined under the license "Multi Control". One license per PC required. There is a single license and a 5-pack available, also a 14-day trial license which can be obtained upon request. More information is available in the user manual of this software or on our website.</p> <div style="border: 1px solid black; padding: 5px; margin-top: 10px;">  For this series PU 10000, which doesn't natively come with a function generator, the Function Generator app in EA Power Control also requires the unlocked function generator in the device itself. See LIZENZFG above. </div>

1.9.5 Options

These options are usually ordered along with the device, as they are permanently built in or preconfigured during the manufacturing process. Post-ordering of cabinet or retrofits upon request.

POWER RACKS 19"-rack	Racks in various configurations up to 42U as parallel systems are available, or mixed with electronic load devices to create test systems. Further information on our website or upon request
WC Water cooling	Replaces the standard cooling blocks of the internal power blocks by three interconnected, water cooled blocks with two taps led out for water supply. This option helps to avoid heating up the environment due to exhausted hot air caused by a certain power dissipation. As a side effect, this type of cooling also reduces audible noise.

1.9.6 The control panel (HMI)

The HMI (Human Machine Interface) consists of six colored LEDs, a pushbutton and a USB port of type B.

1.9.6.1 Status indicators (LED)

The six colored LEDs on the front indicate various statuses of the device:

LED	Color	Indicates what when lit?
Power	orange / green	Orange = device is in boot phase or internal error occurred Green = device is ready for operation
Remote	green	Remote control by master-slave or any of the control interfaces is active. In this situation, manual control with button On/Off is locked.
Error	red	At least one unacknowledged device alarm is active. The LED signalizes all alarms as listed in «3.6 Device alarm handling».
CC	yellow	Constant current regulation (CC) is active. It means, if the LED isn't lit it indicates either CV, CP or CR mode. Also see «3.2 Operating modes».
On	green	DC output is switched on
Off	red	DC output is switched off

1.9.6.2 Front USB port

The front USB port is easier to access than the one on the rear side and intended for quick setup of DC output related values and settings. Doing so is only necessary and possible in these two situations:

1. The PU 10000 6U isn't currently controlled by a master.
2. The PU 10000 6U shall, due to the lack of a suitable PSI 10000 4U or PS 10000 4U master device, be the master of other PU 10000 6U devices.

Both situations are only secondary, as the primary and normal function of a PU 10000 6U is to be a slave in a master-slave system where it's assigned all required settings and values from the master.

When running any of the above listed situations following applies for the front USB port:

	<ul style="list-style-type: none">• Reduced instruction set for master-slave configuration, set values (U, I, P, R) and protections (OVP, OCP, OPP). For details about the instruction set see «3.5 Remote control».• Taking over remote control in order to change the configuration is only possible while the unit isn't online with the master, which either requires to temporarily deactivate master-slave on the master or to switch the master off.• The front USB has no priority over any other remote control interface
---	--

1.9.6.3 Pushbutton "On / Off"



This button can be used to switch the DC output on or off during manual control, i. e. the device isn't in remote control by a master or via any of the USB ports (LED "Remote" = off), but only if the DC output isn't blocked by pin REM-SB (analog interface).

Once pushed to switch the DC output on, the device would regulate it to the last values it has stored. Since all the DC output related values aren't displayed, operating that button has to be done with caution.

The button can furthermore be used to quickly and without the need of a PC turn the device into slave mode. This is done by pressing and holding the button for at least 10 seconds. The switchover into mode "Slave" is confirmed by the LED "Error" lighting up, indicated an MSP alarm (see section «3.6 Device alarm handling» for more information about this alarm) which is normal for not yet initialized slave.

1.9.7 USB port (rear side)

The USB-B port on the rear side of the device is provided for communication with the device and for firmware updates. The included USB cable can be used to connect the device to a PC (USB 2.0 or 3.0). The driver is delivered with the device and installs a virtual COM port. Details for remote control can be found on the web site of the manufacturer or on the included USB stick.

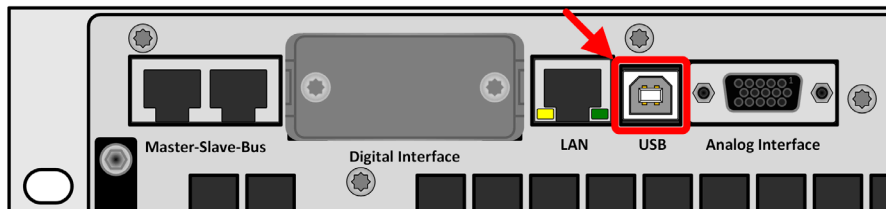

Figure 2 - USB port

Via this port, the device can be addressed either using the international standard ModBus RTU protocol or SCPI language. The device recognizes the message protocol automatically.

If remote control is in operation the USB port has no priority over a probably installed interface module (see below), the front USB port or the analog interface and can, therefore, only be used alternatively to these. However, monitoring is always available.

1.9.8 Interface module slot

This slot on the rear side of the device can receive various modules of the IF-AB interface series. The table below lists the optionally available interface types.

The modules are installed by the user and can be retrofitted anytime. A firmware update of the device may be necessary in order to recognize and support certain modules.

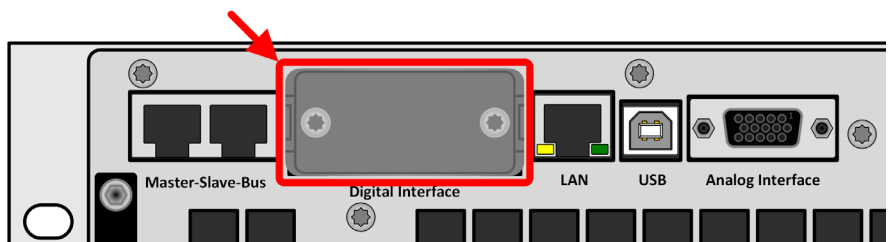

Figure 3 - Interface module slot

Article nr	Name	Description / Connectors
35400100	IF-AB-CANO	CANopen, 1x Sub-D 9pole male
35400101	IF-AB-RS232	RS 232, 1x Sub-D 9pole male (null modem)
35400103	IF-AB-PBUS	Profibus DP-V1 Slave, 1x Sub-D 9pole female
35400104	IF-AB-ETH1P	Ethernet, 1x RJ45
35400105	IF-AB-PNET1P	ProfiNET IO, 1x RJ45
35400107	IF-AB-MBUS1P	ModBus TCP, 1x RJ45
35400108	IF-AB-ETH2P	Ethernet, 2x RJ45
35400109	IF-AB-MBUS2P	ModBus TCP, 2x RJ45
35400110	IF-AB-PNET2P	ProfiNET IO, 2x RJ45
35400111	IF-AB-CAN	CAN 2.0 A / 2.0 B, 1x Sub-D 9-pole, male
35400112	IF-AB-ECT	EtherCAT, 2x RJ45

If remote control is in operation the interface module has no priority over either the USB port or the analog interface and can, therefore, only be used alternately to these. However, monitoring is always available.



Switch off device before adding or removing modules!

1.9.9 Analog interface

This 15-pole Sub-D socket on the back side of the device is provided for remote control of the device via analog or digital signals.

If remote control is in operation this analog interface can only be used alternately to the digital interface. However, monitoring is always available.

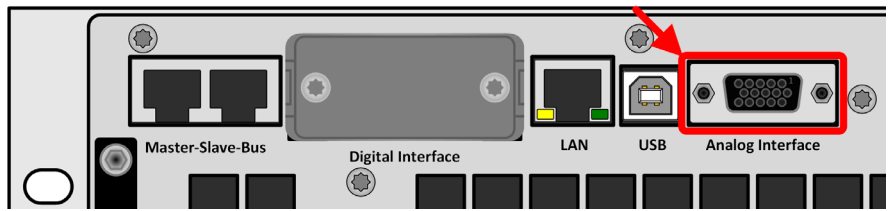

Figure 4 - Analog interface

The input voltage range of the set values and the output voltage range of the monitor values, as well as reference voltage level can be switched with a setting between 0-5 V and 0-10 V, in each case corresponding to 0-100%.

1.9.10 "Share-Bus" connector

The two BNC sockets (50 Ω type) labeled "Share BUS" form a digital, passed-through share bus. This bus is bidirectional and connects the bus master unit via "Share BUS Output" to the next slave unit ("Share BUS Input") etc., for use in parallel operation (master-slave). BNC cables of suitable length can be obtained from us or electronics stores.

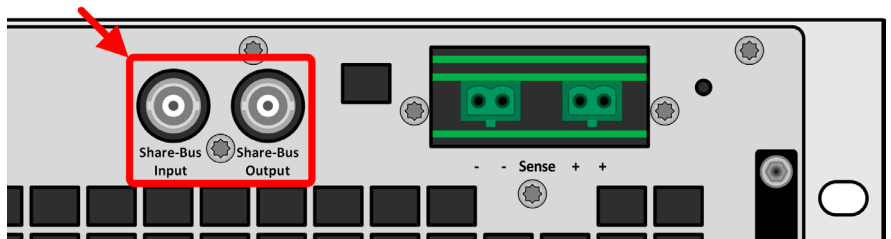

Figure 5 - Share bus

Basically, all 10000 series are compatible on this share bus, though only connection of the same device type, i. e. power supply with power supply or electronic load with electronic load is supported by the devices for master-slave.

For a PU 10000 series device, identical PU 10000 series models can be used as slave units. A PU 10000 device can furthermore be the slave or master of PSI 10000 or PS 10000 series devices.

1.9.11 "Sense" connector (remote sensing)

In order to compensate for voltage drops along the DC cables to the load, the Sense input (2 plugs included in delivery, one each for positive and negative pole) can be connected to the load's DC terminal. The maximum possible compensation is given in the technical specifications.

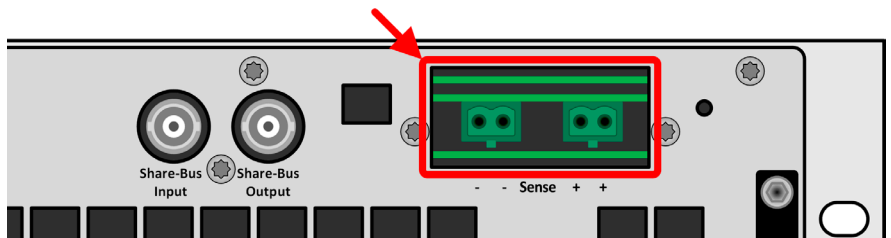

Figure 6 - Remote sensing terminals



In a master-slave system it's intended to wire remote sensing only to the master which would then forward the compensation to the slaves via Share BUS.



The Sense cover must be installed during operation, because there can be hazardous voltage on the sense lines! Reconfiguration on the Sense terminals is only permissible if the device is disconnected from AC supply and all DC sources!

1.9.12 Master-Slave bus

There is a further set of connectors on the rear side of the device, comprising two RJ45 sockets, which enables multiple compatible devices to be connected via a digital bus (RS485) in order to create a master-slave system. Connection is made using standard CAT5 cables.

It's recommended to keep the connections as short as possible and to terminate the bus if required.

The termination is done via digital switches that can be activated by remote control via SCPI or ModBus command, as well as in the Settings app of **EA Power Control**.

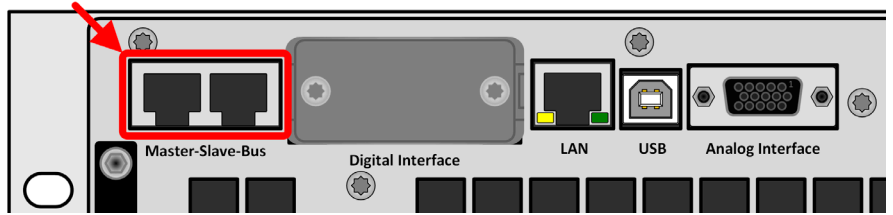

Figure 7 - Master slave bus ports

1.9.13 Ethernet port

The RJ45 LAN/Ethernet port on the rear side of the device is provided for communication with the device in terms of remote control or monitoring. The user has basically two options of access:

1. A website (HTTP, port 80) which is accessible in a standard browser via the IP or the host name given for the device.

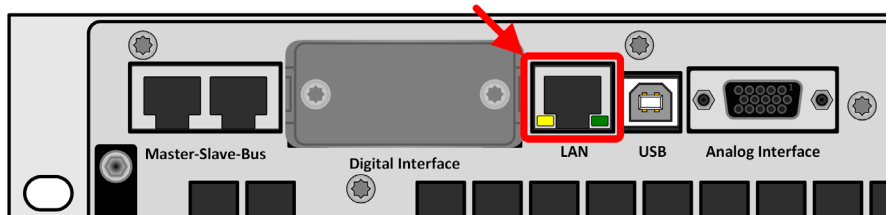

Figure 8 - LAN port

This website offers a configuration page for network parameters, as well as an input box for SCPI commands to control the device remotely by manually entering commands.

2. TCP/IP access via a freely selectable port (except 80 and other reserved ports). The standard port for this device is 5025. Via TCP/IP and the selected port, communication to the device can be established in most of the common programming languages.

Using this LAN port, the device can either be controlled by commands from SCPI or ModBus RTU protocol, while automatically detecting the type of message.

Access via ModBus TCP protocol is only supported by the optionally and separately available ModBus TCP interface module. See «1.9.8 Interface module slot».

The network setup can be done manually or by DHCP. Transmission speed and duplex mode are on automatic mode.

If remote control is in operation the Ethernet port has no priority over any other interface and can, therefore, only be used alternatively to these. However, monitoring is always available.

1.9.14 Water cooling

Contrary to the standard air-cooled versions of the models in this series, water cooling is optionally available. It's built in during the manufacturing process, so retrofitting isn't possible. Cooling the device with water instead of air cooling comes with a few advantages:

- Less ambient noise generated by the device due to a sealed enclosure
- Better cooling at higher ambient temperatures
- No direct dissipation of heat into the ambiance of the device

However, there also disadvantages:

- The device isn't allowed to run under load without active water flow
- Water flow inside an electronic device includes a higher risk of damage caused by a leak or by condensation of water inside the device from air humidity (dewing)

The water taps are located on the rear side of the device, also see the rear view drawing in section 1.8.4. Details about the connection, requirements and use of the water cooling can be found in section 2.3.4.

2. Installation & commissioning

2.1 Transport and storage

2.1.1 Transport



- The handles on the front and rear side of the device are **not** for carrying! Their purpose is to move the device in or out of a cabinet slot.
- Because of its weight, transport by hand should be avoided where possible. If unavoidable then only the housing should be held and not on the exterior parts (handles, DC output, rotary knobs).
- Do not transport when switched on or connected!
- When relocating the equipment use of the original packing is recommended
- The device should always be carried and mounted horizontally
- Use suitable safety clothing, especially safety shoes, when carrying the equipment, as due to its weight a fall can have serious consequences.

2.1.2 Packaging

It's recommended to keep the complete transport packaging for the lifetime of the device for relocation or return to the manufacturer for repair. Otherwise the packaging should be disposed of in an environmentally friendly way.

2.1.3 Storage

In case of long term storage of the equipment it's recommended to use the original packaging or similar. Storage must be in dry rooms, if possible in sealed packaging, to avoid corrosion, especially internal, through humidity.

2.2 Unpacking and visual check

After every transport, with or without packaging, or before commissioning, the equipment should be visually inspected for damage and completeness using the delivery note and/or parts list (see section «1.9.3 Scope of delivery»). An obviously damaged device (e.g. loose parts inside, damage outside) must under no circumstances be put in operation.

2.3 Installation

2.3.1 Safety procedures before installation and use



- The device has a considerable weight. Therefore the proposed location of the equipment (table, cabinet, shelf, 19" rack) must be able to support the weight without restriction.
- When using a 19" rack, rails suitable for the width of the housing and the weight of the device are to be used (see «1.8.3 Specific technical data»)
- Before connecting to the mains ensure that the supply voltage is as shown on the product label. Over-voltage on the AC supply can cause equipment damage.

2.3.2 Preparation

2.3.2.1 Planning a master-slave system

Due to the primary use of PU 10000 series devices being a slave in a master-slave system, before any further planning of installation and wiring it's recommend to decide how the master-slave system shall be configured. The smallest setup would consist of 1x PSI 10000 or PS 10000 and 1x PU 10000, when using a master with display, or 2x PU 10000.

Both, master and slave unit, must be of same rating regarding voltage and ideally also current and power. There are several possible combinations of standard models and the power units:

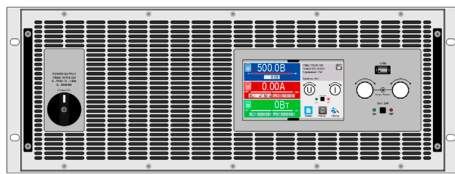

Master

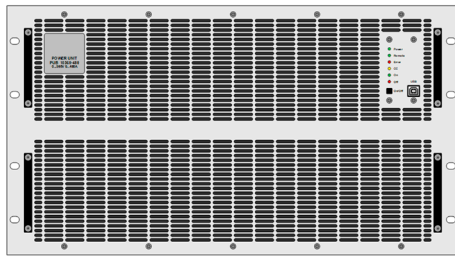

Slave 1

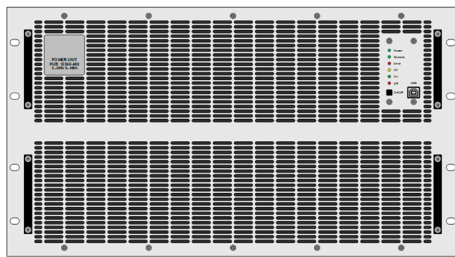

Slave 4

Combination 1:

One 4U master with one or multiple PU 10000 6U as slaves

This is a very comfortable combination, as it allows to have a master which sums up all values on its display and which, if from series PSI 10000, can have a function generator while the slave unit(s) don't need to have one. Four of these slaves plus the 4U master with their total height of 28U fit very well into a 38U cabinet/rack.

Advantage of this combination: lower costs compared to a system where all units are with display. The 6U with the double rated power in only 50% more height add an even higher benefit to the system. This type of master features a USB host port which can be used to record data to USB stick or to quickly load profiles or function generator setups aside from remote control.

Disadvantages of this combination: in case the master fails, the entire system can't either work or at least not use the function generator anymore. After reconfiguring any slave unit to be the master, which can be done via software and remote control, the system can continue to operate with reduced features, but without a values display. However, it can of course be controlled remotely via software.

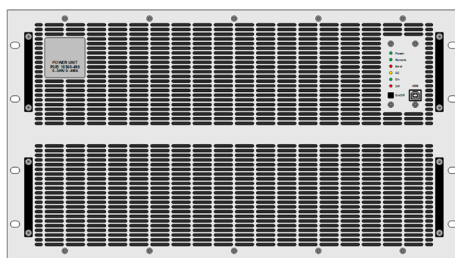

Master

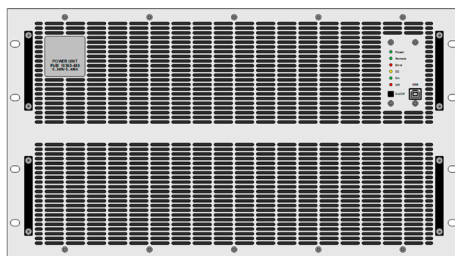

Slave 1

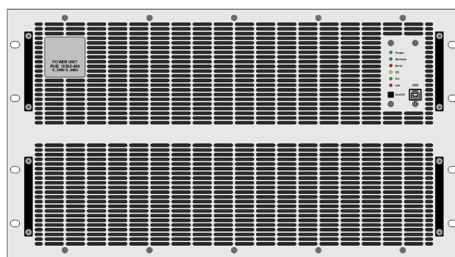

Slave 4

Combination 2:

Multiple PU 10000 6U

An already existing MS system with PU 10000 6U is going to be extended by one or multiple PU 10000 6U units or a new system is built. One of the usually identical devices is picked to be the master and configured accordingly. This combination has the highest potential of cost saving and is ideal when being part of a bigger system where it's intended to be used via remote control only. Five of these units fit very well into a 42U cabinet/rack.

Advantage of this combination: saves costs and space, packs more power in the same height as combination 1.

Disadvantages of this combination: if the system only consist of models of PU 10000 series, the available features are limited to what is defined for a single device. Changing the configuration requires access via a PC, either on the front or rear USB port.

2.3.2.2 Selecting cables

The required AC supply connection for these devices is hardwiring. It's done via the 4 pole AC connector on the rear (AC filter box). Wiring of the plug must be 4 wire (3x L, PE) of suitable cross section.

For recommendations of a cable cross section see «2.3.5 Connection to AC supply». Dimensioning of the DC wiring to the load/consumer has to reflect the following:



- The cable cross section should always be specified for at least the maximum current of the device.
- Continuous operation at the approved limit generates heat which must be removed, as well as voltage loss which depends on cable length and heating. To compensate for these the cable cross section should be increased and the cable length reduced.

2.3.3 Installing the device



- Select the location for the device so that the connection to the load resp. source is as short as possible.
- Leave sufficient space, at least 30 cm (1 ft), behind the equipment for ventilation (only required for the standard air-cooled version)
- The device must not be operated without a proper touch protection on the AC connector, which is either only accomplished by installation of the device in a 19" rack/cabinet with lockable doors or by applying further measures (additional cover etc.)

A device in a 19" chassis will usually be mounted on suitable rails and installed in 19" racks or cabinets. The depth of the device and its weight must be taken into account. The handles on the front and rear are for help with sliding in and out of the cabinet. Slots on the front plate are provided for fixing the device (fixing screws not included).

The unacceptable positions, as shown below, are also valid for the vertical mount of the device onto a wall or inside a cabinet. The required air flow would be insufficient. This wouldn't actually apply to water cooled models, but the construction of the entire device isn't made for operation in this position.

Acceptable and unacceptable installation positions (air or water cooled, air cooled shown):

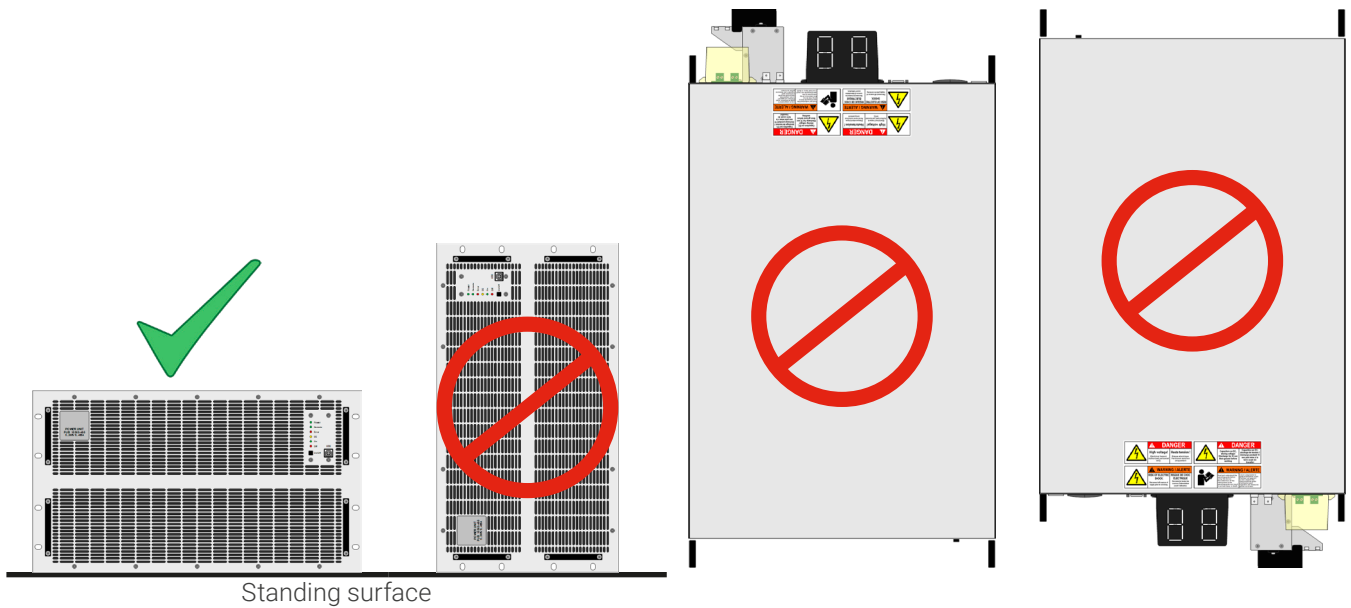

2.3.4 Installing the water cooling

If present, the water cooling should be connected and any further measures related to water cooling installation should be carried out before the AC supply for the device is connected, let alone the unit is powered. Correct installation and connection, test for watertightness and later operation lie in the sole responsibility of the operator or end user.

2.3.4.1 Requirements

The water pipe construction is identical with all models in this series but due to the rated current and hence different heat dissipation per minute in the internal cooling block, a model depending requirement to the water and the ambience must be met:

Model	360 V to 2000 V
Internal water flow:	Series
Ambient temperature:	Max. +50 °C (122 °F)
Water intake temperature (min):	See dew point tables below
Water intake temperature (max):	+26 °C (91 °F)
Flow rate:	Min. 7 l/minute (1.85 gal/minute)
Corrosion protection:	Ethylene glycol
Water hardness:	Soft (calcium carbonate < 2 mmol/l)
Water pressure:	Min. 1 bar (14 psi), max. 4 bar (58 psi)

2.3.4.2 Connection point

The device has three separate cooling blocks internally, each with its own water pipe. All pipes are led out and connected outside of the device. The water flows through all three pipes in series. On the rear of the device are two taps (tee pieces) for water connection:

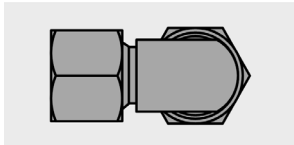

Tap: 10 mm hose, M19 nut

Which one of the two taps is used for intake and outlet is arbitrary. For later use it's only important to have a sufficient amount of water flowing through the pipes, along with a certain water intake temperature.

The hose connection is either directly done on the tap or by using a hose tail swivel, for example one from company Schwer Fittings, type SA-DKL90. This swivel is already sealing upon mount, using a 24° metal cone. The hose is required to have an outer diameter of 9 mm to max. 10 mm.

2.3.4.3 Operation and supervision

Once the water cooling is installed and running, there is one primary value left to supervise permanently, the so-called dew point. Depending on the temperature of water on the intake in combination with the humidity of ambient air and also the air inside the device water can condensate, i. e. dew inside the device. This must be avoided under all circumstances! It means, it might be required to have a regulated radiation system in order to react to varying ambient conditions.

The dew point is defined in several norms, for instance DIN 4108. The table below defines the dew point (air humidity to water) **in °C in the upper table** and **in °F in the lower table** at specific ambient temperatures and air humidity levels. The intake water temperature must always be higher than the dew point:

Ambient	Relative air humidity in per cent										
	45%	50%	55%	60%	65%	70%	75%	80%	85%	90%	95%
14°C	2.2	3.76	5.1	6.4	7.58	8.67	9.7	10.71	11.64	12.55	13.36
15°C	3.12	4.65	6.07	7.36	8.52	9.63	10.7	11.69	12.62	13.52	14.42
16°C	4.07	5.59	6.98	8.29	9.47	10.61	11.68	12.66	13.63	14.58	15.54
17°C	5	6.48	7.92	9.18	10.39	11.48	12.54	13.57	14.5	15.36	16.19
18°C	5.9	7.43	8.83	10.12	11.33	12.44	13.48	14.56	15.41	16.31	17.25
19°C	6.8	8.33	9.75	11.09	12.26	13.37	14.49	15.47	16.4	17.37	18.22
20°C	7.73	9.3	10.72	12	13.22	14.4	15.48	16.46	17.44	18.36	19.18
21°C	8.6	10.22	11.59	12.92	14.21	15.36	16.4	17.44	18.41	19.27	20.19
22°C	9.54	11.16	12.52	13.89	15.19	16.27	17.41	18.42	19.39	20.28	21.22
23°C	10.44	12.02	13.47	14.87	16.04	17.29	18.37	19.37	20.37	21.34	22.23
24°C	11.34	12.93	14.44	15.73	17.06	18.21	19.22	20.33	21.37	22.32	23.18
25°C	12.2	13.83	15.37	16.69	17.99	19.11	20.24	21.35	22.27	23.3	24.22
26°C	13.15	14.84	16.26	17.67	18.9	20.09	21.29	22.32	23.32	24.31	25.16
27°C	14.08	15.68	17.24	18.57	19.83	21.11	22.23	23.31	24.32	25.22	26.1
28°C	14.96	16.61	18.14	19.38	20.86	22.07	23.18	24.28	25.25	26.2	27.18

Ambient	Relative air humidity in per cent										
	45%	50%	55%	60%	65%	70%	75%	80%	85%	90%	95%
29°C	15.85	17.58	19.04	20.48	21.83	22.97	24.2	25.23	26.21	27.26	28.18
30°C	16.79	18.44	19.96	21.44	23.71	23.94	25.11	26.1	27.21	28.19	29.09
32°C	18.62	20.28	21.9	23.26	24.65	25.79	27.08	28.24	29.23	30.16	31.17
34°C	20.42	22.19	23.77	25.19	26.54	27.85	28.94	30.09	31.19	32.13	33.11
36°C	22.23	24.08	25.5	27	28.41	29.65	30.88	31.97	33.05	34.23	35.06
38°C	23.97	25.74	27.44	28.87	30.31	31.62	32.78	33.96	35.01	36.05	37.03
40°C	25.79	27.66	29.22	30.81	32.16	33.48	34.69	35.86	36.98	38.05	39.11
45°C	30.29	32.17	33.86	35.38	36.85	38.24	39.54	40.74	41.87	42.97	44.03
50°C	34.76	36.63	38.46	40.09	41.58	42.99	44.33	45.55	46.75	47.9	48.98

Ambient	Relative air humidity in per cent										
	45%	50%	55%	60%	65%	70%	75%	80%	85%	90%	95%
58°F	36	38.8	41.2	43.6	45.7	47.7	49.5	51.3	53	54.6	56.1
59°F	37.7	40.4	43	45.3	47.4	49.4	51.3	53.1	54.8	56.4	58
61°F	39.4	42.1	44.6	47	49.1	51.1	53.1	54.8	56.6	58.3	60
63°F	41	43.7	46.3	48.6	50.8	52.7	54.6	56.5	58.1	59.7	61.2
65°F	42.7	45.4	47.9	50.3	52.4	54.4	56.3	58.3	59.8	61.4	63.1
67°F	44.3	47	49.6	52	54.1	56.1	58.1	59.9	61.6	63.3	64.8
68°F	46	48.8	51.3	53.6	55.8	58	59.9	61.7	63.4	65.1	66.6
70°F	47.5	50.4	52.9	55.3	57.6	59.7	61.6	63.4	65.2	66.7	68.4
72°F	49.2	52.1	54.6	57.1	59.4	61.3	63.4	65.2	67	68.6	70.2
74°F	50.8	53.7	56.3	58.8	60.9	63.2	65.1	66.9	68.7	70.5	72.1
76°F	52.5	55.3	58	60.4	62.8	64.8	66.6	68.6	70.5	72.2	73.8
77°F	54	56.9	59.7	62.1	64.4	66.4	68.5	70.5	72.1	74	75.6
79°F	55.7	58.8	61.3	63.9	66.1	68.2	70.4	72.2	74	75.8	77.3
81°F	57.4	60.3	63.1	65.5	67.7	70	72.1	74	75.8	77.4	79
83°F	59	61.9	64.7	66.9	69.6	71.8	73.8	75.8	77.5	79.2	81
85°F	60.6	63.7	66.3	68.9	71.3	73.4	75.6	77.5	79.2	81.1	82.8
86°F	62.3	65.2	68	70.6	74.7	75.1	77.2	79	81	82.8	84.4
90°F	65.6	68.6	71.5	73.9	76.4	78.5	80.8	82.9	84.7	86.3	88.2
94°F	68.8	72	74.8	77.4	79.8	82.2	84.1	86.2	88.2	89.9	91.6
97°F	72.1	75.4	77.9	80.6	83.2	85.4	87.6	89.6	91.5	93.7	95.2
101°F	75.2	78.4	81.4	84	86.6	89	91.1	93.2	95.1	96.9	98.7
104°F	78.5	81.8	84.6	87.5	89.9	92.3	94.5	96.6	98.6	100.5	102.4
113°F	86.6	90	93	95.7	98.4	100.9	103.2	105.4	107.4	109.4	111.3
122°F	94.6	98	101.3	104.2	106.9	109.4	111.8	114	116.2	118.3	120.2

2.3.4.4 Notes

- The water flow should be started prior to powering the device, but at least prior to switching the DC terminal on

2.3.5 Connection to AC supply



- Connection to an AC supply must only be carried out by qualified personnel and the device must be rigidly connected to a main supply point!
- The AC cable cross section must be suitable for the maximum input current of the device! See tables below. The device should furthermore be fused externally and according to the maximum current rating!
- WC models: For safety reasons it's recommended to install a 30 mA RCD for every water-cooled unit (option WC) or at least one per three units
- The devices don't feature a power switch, so they definitely require to be powered by external means, such as a contactor or a main switch or directly at the required external 3-phase circuit breaker
- In a cabinet system with 1 - 5 units per cabinet and when powering all units in the cabinet at once by the external switching installation, very high inrush current can appear. The external switching installation must be capable of these high currents!

2.3.5.1 AC supply requirements

No matter what particular device variant or hardware revision is present, the rated AC supply voltage on the type label is decisive. They all use a regular three-phase supply without N. Specification:

Rated power	Inputs on AC terminal	Supply type	Configuration
60 kW	L1, L2, L3, PE	Three-phase (3P)	Delta



The PE conductor is imperative and must always be wired to the AC plug!

2.3.5.2 Cross section

For the selection of a suitable cable cross section, the rated AC current of the device and the cable length are decisive. Based on the connection of a **single unit** the table below lists the maximum input current and recommended minimum cross section for each phase. The value to pick also heavily depends on the available cable type. Due to the high AC current of this device series, the cross section is minimum 16 mm² (special cable, e. g. NSGAÖU) or 35 mm² (standard cable):

Power	L1		L2		L3		PE
	∅	I _{max}	∅	I _{max}	∅	I _{max}	∅
60 kW at 380/400/480 V	≥16 mm ²	110 A	≥16 mm ²	110 A	≥16 mm ²	110 A	≥16 mm ²

2.3.5.3 AC terminal, AC cable and connection

The AC terminal is a screw type and designed for the use of ring or fork cable lugs. The minimum cable requirements are defined in 2.3.5.2 while the maximum usable cross section depends on the selected lug. The lug itself is restricted to be for M6 and to have a maximum width of 15 mm, due to the AC terminal construction.

The longer the connection cables, the higher the voltage loss due to the cable resistance. Therefore the mains cables should be kept as short as possible or have an even bigger cross section than required. Each of the 4 phases (3x L plus PE) requires a wire.

The included AC terminal cover should be mounted all the time when operating the device. For the strain relief caused by the thick and heavy wires a bracket is already installed on the side of the AC filter box. Cable ties to fix the wire are included in the scope of delivery. See section «2.3.5.4 Mounting the strain relief».

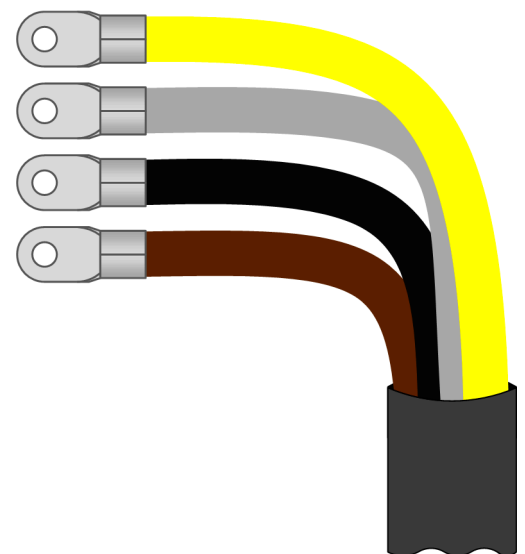

Figure 9 - Example for an AC cable (wire bundling)

2.3.5.4 Mounting the strain relief

All models and variants include a strain relief for the AC cable in their scope of delivery. This strain relief is recommended to be used by the installer, unless a different kind of strain relief is intended and installed. Installation steps:

1. Arrange the wires that go to the AC terminal horizontally and in front of the pre-mounted bracket, as depicted in *Figure 10* below.
2. Fix two wires each with one or two cable ties (recommended).
3. Place AC cover. The required screws are pre-installed on the AC filter enclosure.

In case it becomes necessary to remove the device from the installation place (cabinet or other), the bracket for the strain relief can remain tied to the wires, because it can be dismantled from the side of the AC filter box (4x screw). The rest would be to unscrew the four AC cable ends with the lugs.

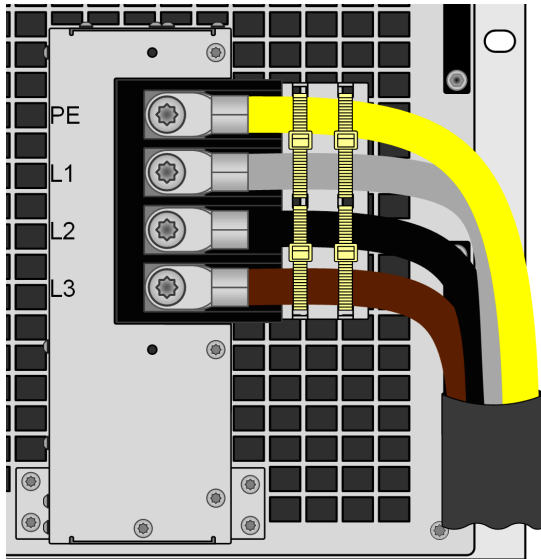

Figure 10 - Fully installed strain relief

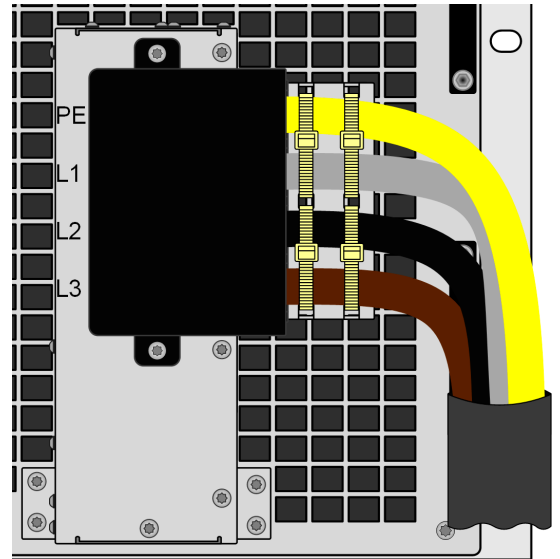

Figure 11 - Complete AC connection

2.3.5.5 Grounding the enclosure

All devices feature a grounding point on the rear plate, as depicted in the figure to the right

For reasons of safety for people working with the device which, amongst other measures, is achieved by keeping the leakage current as low as possible, the enclosure can be grounded here additionally to the AC input grounding. It requires a separate protective earth line (PE), being connected to the grounding point. The cross section of that line must be at least the same as with the ground conductor in the AC supply cables.

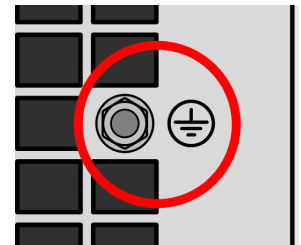

Figure 12 - Grounding point

2.3.6 Connection to DC loads



- In case of a model with a high rated DC current and hence thick and heavy DC connection cables it's necessary to take account of the weight of the cables and the strain imposed on the DC connection. Especially when mounted in a 19" cabinet or similar, where the cable could hang on the DC terminal, any kind of strain reliever must be used.
- Besides the proper cross section of DC cables the proper electric strength (withstand voltage) of the cables must be considered.



No false polarity protection inside! Loads which are also sources, such as batteries, will damage the device when connected with false polarity, also when not the device isn't powered!



When connected to DC, a load that is also a source charges the internal capacities on the DC terminal, even when the device isn't powered. Dangerous voltage levels can be present on the DC terminal, also after disconnection of that external source.

The DC output terminal is on the rear side of the device and **is not** protected by a fuse. The cross section of connection cables is depending on the current consumption, cable length and ambient temperature.

For standard cables **up to 5 m** and average ambient temperature **up to 30°C** we recommend:

up to 80 A :	16 mm ²	up to 120 A :	35 mm ²
up to 160 A :	50 mm ²	up to 240 A :	95 mm ²
up to 360 A :	2x70 mm ²	up to 480 A :	2x 95 mm ²

per connection pole (multi-conductor, insulated, openly suspended). Single cables of, for example, 70 mm² may be replaced by e.g. 2x 35 mm² etc. If the cables are long then the cross section must be increased to avoid voltage loss and overheating.

2.3.6.1 DC terminal

The table below shows an overview of the various DC terminals. It's recommended that connection of load cables always utilizes flexible cables with ring lugs.

All models
<p>M8 bolt on a metal rail</p> <p>Recommendation: ring lug with a hole for M8 or similar</p>

2.3.6.2 Cable lead and plastic cover

Included in the delivery of the device is a plastic cover for contact protection. It should always be installed. There are breakouts so that the DC cable can be laid in various directions. Examples:

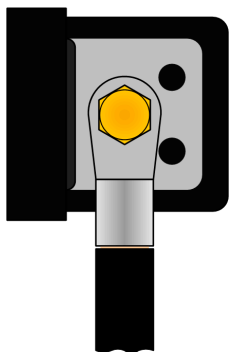

- 90° up or down
- space saving in depth
- no bending radius

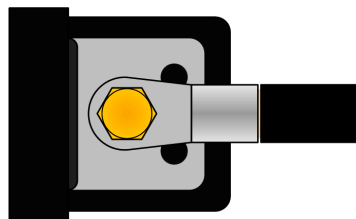

- horizontal lead
- space saving in height
- large bending radius

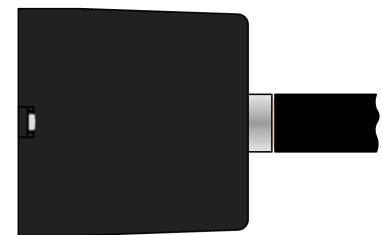

2.3.7 Grounding of the DC terminal

The extra grounding point on the rear plate, as marked in the figure to the right, can be used to ground any of the DC terminal poles. Doing so causes a potential shift on the opposite pole against PE. Because of insulation, the maximum allowed potential shift especially of the negative DC terminal pole is limited and also depends on the device model. Refer to «1.8.3 Specific technical data» for details.

Both poles on the DC terminal are floating, which is considered as a basic protection in terms of human body safety. Grounding any DC terminal voids that basic protection.

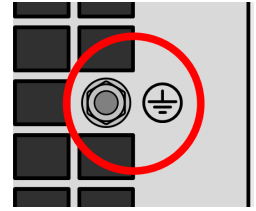

In case any DC pole is grounded, the operator of the device must reinstate the basic protection for human safety by installing appropriate external means, for instance a cover, everywhere the potential of the DC terminal is connected to.

2.3.8 Connection of remote sense



- Remote sensing is only effective during constant voltage operation (CV) and for other regulation modes the sense input should be disconnected, if possible, because connecting it generally increases the oscillation tendency
- The cross section of the sense cables is noncritical. Recommendation for cables up to 5 m (16.4 ft): use at least 0.5 mm²
- Sense cables shouldn't be twisted, but laid close to the DC cables, i. e. Sense- cable close to DC- cable to the load etc. to damp or avoid possible oscillation. If necessary, an additional capacitor should be installed at the load/consumer to eliminate oscillation
- The Sense+ cable must be connected to DC+ on the load and Sense- to DC- at the load, otherwise the sense input of the power supply can be damaged. For an example see Figure 13 below.
- In master-slave operation, the remote sensing must be connected to the master unit only
- The dielectric strength of the sense wires must always at least match the DC voltage rating!



Dangerous voltage on the sense terminals! The sense cover must always be installed.

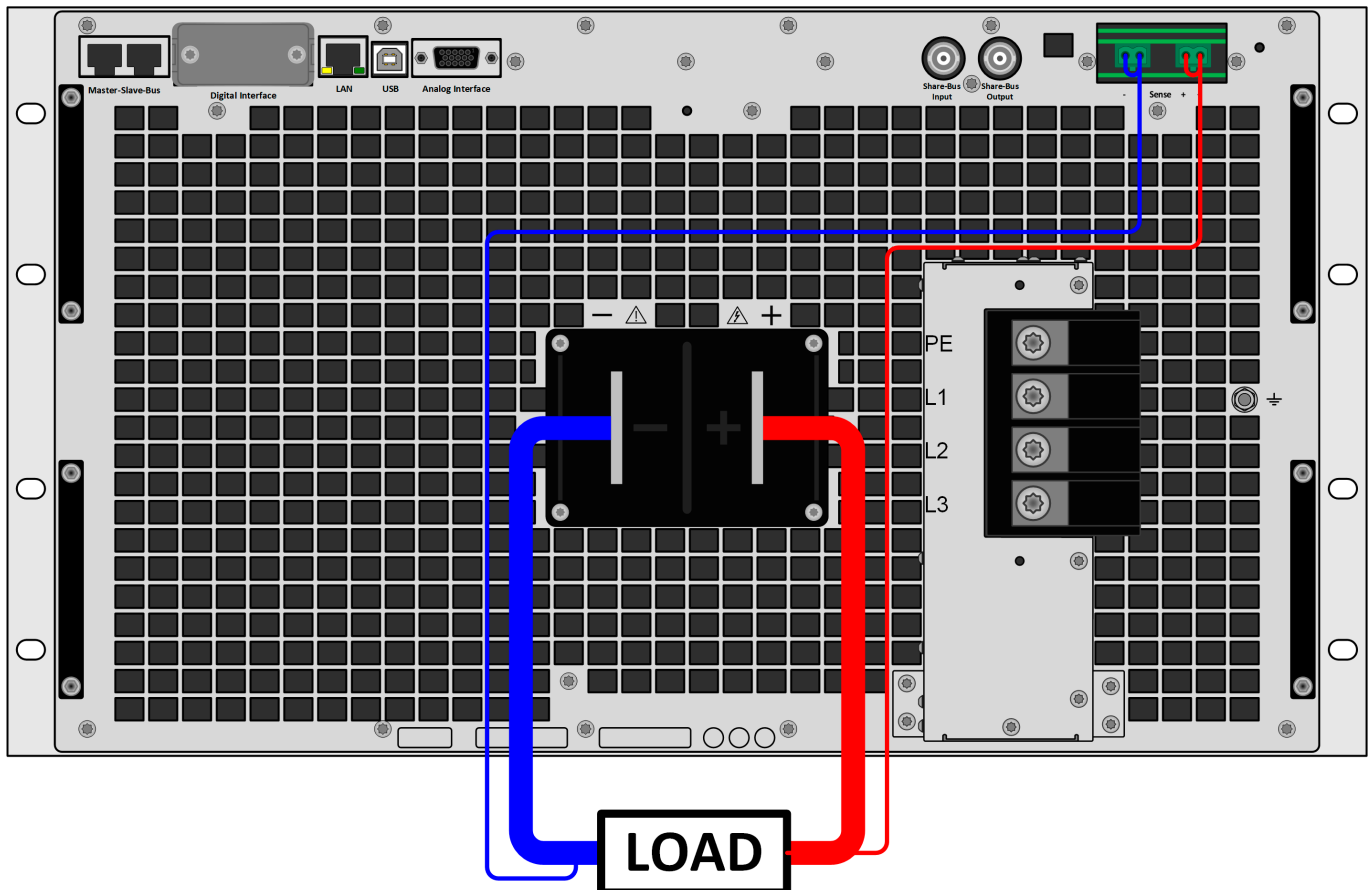
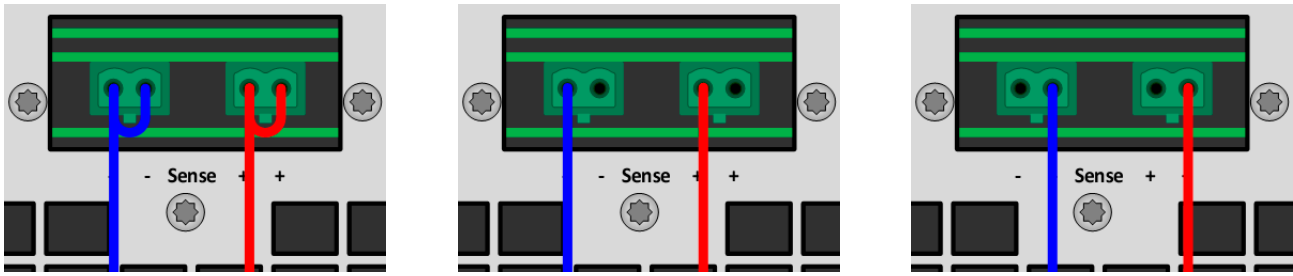

Figure 13 - Example for remote sensing wiring (DC terminal and Sense terminal covers left away for illustrative purposes)

Allowed connection schemes:



2.3.9 Installation of an interface module

The optionally obtainable interface modules can be retrofitted by the user and are exchangeable with each other. The settings for the currently installed module vary and need to be checked and, if necessary, corrected on initial installation and after module exchange.



- Common ESD protection procedures apply when inserting or exchanging a module.
- The device must be switched off before insertion or removal of a module
- Never insert any other hardware other than an interface module into the slot
- If no module is in use it's recommended that the slot cover is mounted in order to avoid internal dirtying of the device and changes in the air flow (standard models with air-cooling)

Installation steps:

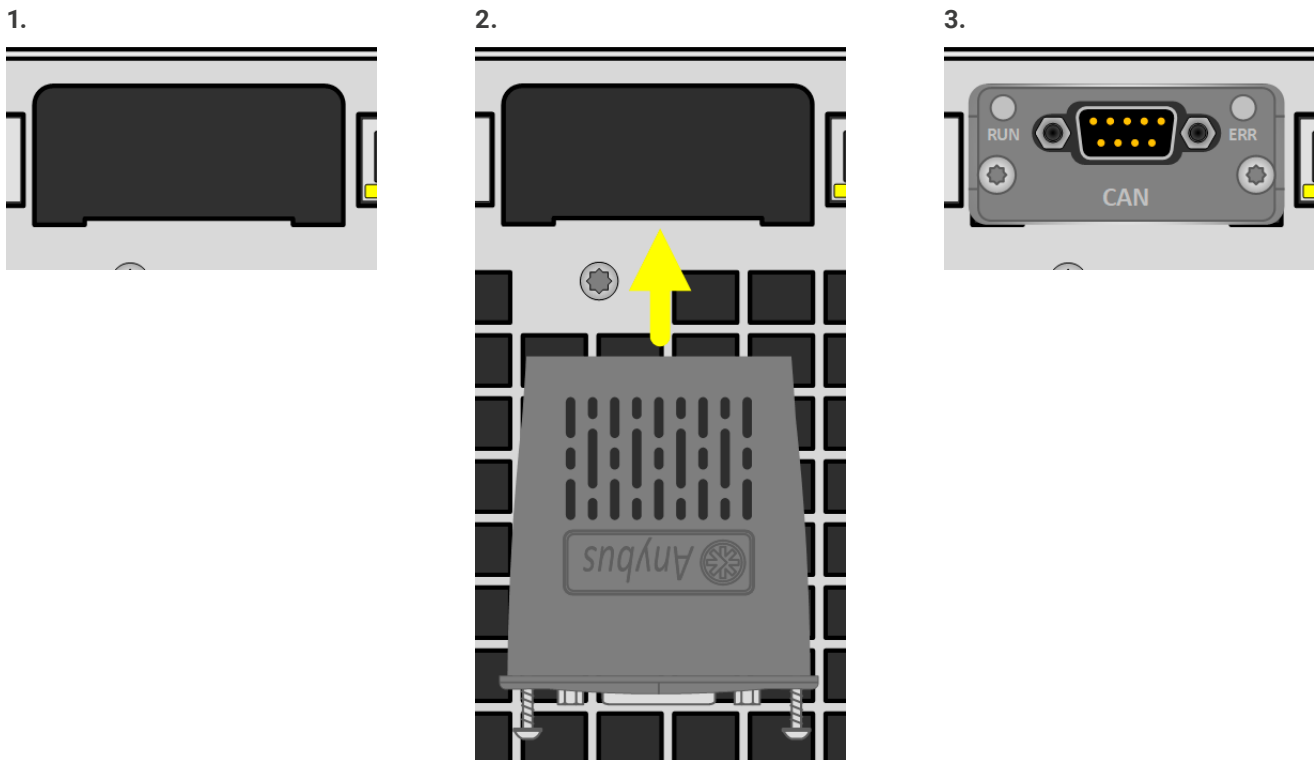

1. Remove the slot cover. If needed, use a screw driver.

2. Insert the interface module into the slot. The shape ensures correct alignment.

When inserting take care that it's held as close as possible to a 90° angle to the rear wall of the device. Use the green PCB which you can recognize on the open slot as guide. At the end is a socket for the module.

On the bottom side of the module are two plastic nibs which must click into the green board (PCB) so that the module is properly aligned on the rear wall of the device.

3. The screws (Torx 8) are provided for fixing the module and should be fully screwed in. After installation, the module is ready for use and can be connected.

Removal follows the reverse procedure. The screws can be used to assist in pulling out the module.

2.3.10 Connecting the analog interface

The 15-pole connector (Type: Sub-D, D-Sub) on the rear side is an analog interface. To connect this to a controlling hardware (PC, electronic circuit), a standard plug is necessary (not included in the scope of delivery). It's generally advisable to switch the device completely off before connecting or disconnecting this connector, but at least the DC output.

2.3.11 Connecting the share bus

The "Share BUS" connectors on the rear side (2x BNC type) can be used to connect to the share bus of further units. The main purpose of the share bus is to balance the voltage of multiple units in parallel operation. For further information about parallel operation refer to section «3.7.1 Parallel operation in master-slave (MS)».

For the connection of the share bus the following must be paid attention to:



Connection is only permitted between compatible devices (see «1.9.10 "Share-Bus" connector» for details) and between a max. of 64 units

2.3.12 Connecting the USB ports

In order to remotely control the device via any of the two USB port (front and rear), connect the device with a PC using the included USB cable and switch the device on.

2.3.12.1 Driver installation (Windows)

On the initial connection with a PC the operating system will identify the device as new hardware and will try to install a driver. The required driver is for a Communication Device Class (CDC) device and is usually integrated in current operating systems such as Windows 7 or 10. But it's strongly recommended to use the included driver installer (on USB stick) to gain maximum compatibility to our softwares.

2.3.12.2 Driver installation (Linux, MacOS)

We can't provide drivers or installation instructions for these operating systems. Whether a suitable driver is available is best carried out by searching the Internet.

2.3.12.3 Alternative drivers

In case the CDC drivers described above are not available on your system, or for some reason do not function correctly, commercial suppliers can help. Search the Internet for suppliers using the keywords "cdc driver windows" or "cdc driver linux" or "cdc driver macos".

2.3.13 Initial commission

For the first start-up after installation of the device, the following procedures have to be executed:

- Confirm that the connection cables to be used are of a satisfactory cross section!
- Check if the factory settings of set values, safety and monitoring functions and communication are suitable for your intended application of the device and adjust them if required, as described in the manual!
- In case of remote control via PC, read the additional documentation for interfaces and software!
- In case of remote control via the analog interface, read the section in this manual concerning analog interfaces!

2.3.14 Commission after a firmware update or a long period of non-use

In case of a firmware update, return of the equipment following repair or a location or configuration change, similar measures should be taken to those of initial start up. Refer to «2.3.13 Initial commission».

Only after successful checking of the device as listed may it be operated as usual.

3. Operation and application

3.1 Personal safety



- In order to guarantee safety when using the device, it's essential that only persons operate the device who are fully acquainted and trained in the required safety measures to be taken when working with dangerous electrical voltages
- For models which can generate a voltage which is dangerous by contact, or are connected to such, the included DC terminal cover or an equivalent must always be used
- Whenever the load and DC output are being re-configured, the device should be disconnected from the mains, not only the DC output switched off!

3.2 Operating modes

A power supply is internally controlled by different control circuits, which shall regulate voltage, current and power to the adjusted values and hold them constant, if possible. These circuits follow typical laws of control systems engineering, resulting in different operating modes. Each operating mode has its own characteristics which are explained below in short form.



- *Unloaded operation isn't considered as a normal operation mode and can thus lead to false measurements, for example when calibrating the device*
- *The optimal working point of the device is between 50% and 100% voltage and current*
- *It's recommended to not run the device below 10% voltage and current, in order to meet technical values like ripple or transient times*

3.2.1 Voltage regulation / Constant voltage

Voltage regulation is also called constant voltage operation (CV).

The DC output voltage of a power supply is held constant on the adjusted value, unless the output current or the output power according to $P = U_{OUT} \cdot I_{OUT}$ reaches the adjusted current or power limit. In both cases the device will automatically change to constant current or constant power operation, whatever occurs first. Then the output voltage can't be held constant anymore and will sink to a value resulting from Ohm's law.

While the DC output is switched on and constant voltage mode is active, then the condition "CV mode active" will be indicated as signal on the analog interface and can also be read as status via the digital interfaces.

3.2.1.1 Voltage regulation peaks

When working in constant voltage regulation (CV), the device's internal voltage regulator requires a small transient time to settle the voltage after a load step. Negative load steps, i.e. high load to lower load, will cause the output voltage to overshoot for a short time until compensated by the voltage regulator. The time it takes to settle the voltage can be influenced by switching the voltage regulation speed between the settings **Slow**, **Normal** and **Fast**, whereas Normal is the default. This is done in the Settings app of **EA Power Control**. Setting **Slow** will result in a higher transient time and higher voltage drop, but less overshooting, while **Fast** is vice versa.

Depictions:

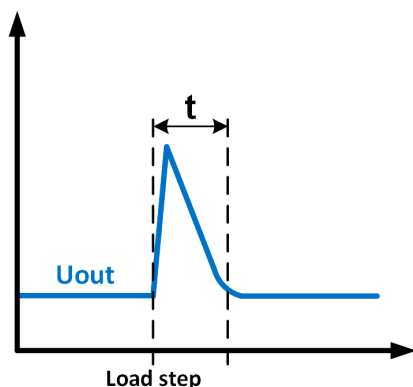

Example for a neg. load step: the DC output will rise above the adjusted value for a short time. t = transient time to settle the output voltage.

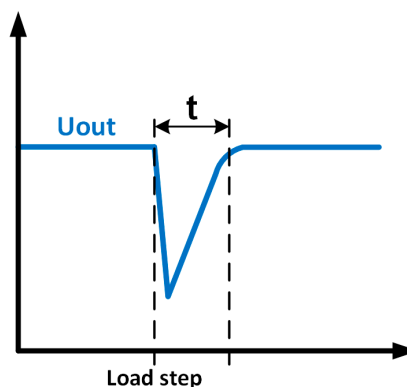

Example for a pos. load step: the DC output will collapse below the adjusted value for a short time. t = transient time to settle the output voltage.

3.2.2 Current regulation / constant current / current limiting

Current regulation is also known as current limiting or constant current mode (CC).

The DC output current is held constant by the power supply, once the output current to the load reaches the adjusted limit. Then the power supply automatically switches to CC. The current flowing from the power supply is determined by the output voltage and the load's true resistance. As long as the output current is lower than the adjusted current limit, the device will be either in constant voltage or constant power mode. If, however, the power consumption reaches the adjusted power value, the device will switch automatically to power limiting and sets the output current according to $I_{MAX} = P_{SET} / U_{IN}$, even if the maximum current value is higher. The current set value, as determined by the user, is always an upper limit.

While the DC output is switched on and constant current mode is active, the condition "CC mode active" will be indicated on the front side control panel by LED "CC" and can also be read as status via the digital interfaces.

3.2.2.1 Voltage overshootings

In certain situations it's possible that the device generates a voltage overshooting. Such situations are when the device is in CC, with the actual voltage being unregulated, and either a jump in the current set value is initiated which would bring the device out of CC or when the load is suddenly cut from the power supply by an external means. Peak and duration of the overshooting aren't exactly defined, but as rule of thumb it shouldn't exceed a peak of 1-2% of the rated voltage (on top of the voltage setting) while the duration mainly depends on the charging state of the capacities on the DC output and also the capacity value.

3.2.3 Power regulation / constant power / power limiting

Power regulation, also known as power limiting or constant power (CP), keeps the DC output power of a power supply constant if the current flowing to the load in relation to the output voltage and the resistance of load reaches the adjusted value according to $P = U * I$ resp. $P = U^2 / R$. The power limiting then regulates the output current according to $I = \sqrt{P / R}$, where R is the load's true resistance.

Power limiting operates according to the auto-range principle such that at lower output voltages higher current flows and vice versa in order to maintain constant power within the range P_N (see diagram to the right).

While the DC output is switched on and constant power mode is active, the condition "CP mode active" can only be read as status via the digital interfaces.

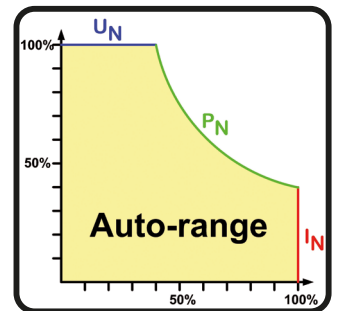

3.2.4 Internal resistance regulation

Internal resistance control (short: CR) of power supplies is the simulation of a virtual internal resistor which is in series to the load. According to Ohm's law, this resistance causes a voltage drop, which will result in a difference between the adjusted output voltage and the actual output voltage. This will also work in CC or CP mode whereas the actual output voltage will differ even more from the adjusted voltage, because both modes limit the output voltage additionally. CR mode is actually running in CV, but will be indicated as status "CR" (via the digital interfaces only) once the adjusted resistance value is reached.

The available resistance range of a particular model is given in the technical specifications. The voltage regulation in dependency of the resistance set value and the output current is done by calculation in a fast FPGA controller, being only a little slower than other controllers inside the main control circuit. Clarification:

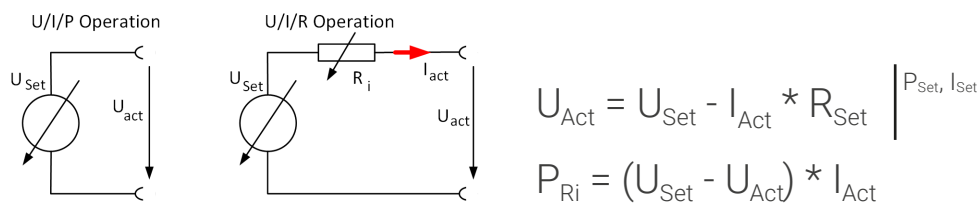

3.3 Alarm conditions



This section only gives an overview about device alarms. What to do in case your device indicates an alarm condition is described in section «3.6 Device alarm handling».

Alarm conditions are those coming from the hardware of the device. As a basic principle, all alarm conditions are signaled optically (LED on the front, collection error), as a readable status via the digital interface and as signal on the analog interface (collection error). The indication on the analog interface is by default configured to signal only OT and OVP, but can be adapted to signal the others as well while not every alarm is available as single indication. Once a collection error has occurred, the specific alarm can only be acquired via digital interface. For acquisition and statistics of already gone alarms, an alarm counter can be read from the display or via digital interface.

3.3.1 Power Fail

Power Fail (PF) indicates an alarm condition which may have various causes:

- AC input voltage became too low during runtime (mains undervoltage, mains failure)
- Defect in the input circuit (PFC)

As soon as a power fail occurs, the device will stop to supply power and switch the DC output off. In case the power fail was an undervoltage and will be gone later on, the device can automatically continue to work as before. This depends on a setting which is either available in the Settings app of **EA Power Control** under **Other -> DC input/output state after PF alarm** or as ModBus/SCPI command. The default setting would keep the DC output switched "Off" and leave the alarm on the front panel for notification.



Powering the device down can't be distinguished from an AC supply blackout and thus the device will signalize a PF alarm every time it's actually powered down.

3.3.2 Overtemperature

An overtemperature alarm (OT) can occur from an excess temperature inside the device and temporarily causes it to switch the DC terminal off. This is usually due to the ambient temperature exceeding the specified operating temperature range of the device. After cooling down, the device can automatically switch the DC output back on. This is determined via a setting that can either be access in the Settings app of **EA Power Control** under **Other -> DC input/output state after OT alarm** or via ModBus/SCPI command.

3.3.3 Overvoltage protection

An overvoltage alarm (OVP) will switch off the DC output and can occur if:

- the power supply itself, as a voltage source, generates an output voltage higher than set for the overvoltage alarm threshold (OVP, 0...110% U_{Nom}) or the connected load somehow returns voltage higher than this threshold
- the OVP threshold has been adjusted too close above the output voltage. If the device is in CC mode and if it then experiences a negative load step it will make the voltage rise quickly, resulting in a voltage overshoot for a short moment which can already trigger the OVP

This function serves to warn the user optically via LED "Error" that the device has probably experienced an excessive voltage from outside which could have damaged it.



- The device isn't fitted with protection from external overvoltage
- The changeover from operation modes CC -> CV can generate voltage overshoots

3.3.4 Overcurrent protection

An overcurrent alarm (OCP) will switch off the DC output and can occur if:

- the output current in the DC output reaches the adjusted OCP limit.

This function serves to protect the connected load application so that this isn't overloaded and possibly damaged due to an excessive current.

3.3.5 Overpower protection

An overpower alarm (OPP) will switch off the DC output and can occur if:

- the product of the output voltage and output current in the DC output reaches the adjusted OPP limit.

This function serves to protect the connected load application so that this isn't overloaded and possibly damaged due to an excessive power consumption.

3.3.6 Share bus fail

The share bus fail alarm (short: SF) is related to the physical share bus (connectors on the rear side of the device) and the condition whether it's connected to at least one other device or not. The alarm is also related to the configuration of master-slave mode.

Depending on the situation, the share bus of the involved devices must either be connected or disconnected or else the alarm might occur, preventing to switch the DC output on. Should the alarm occur in the middle of normal operation, it would switch the DC output off. Possible causes for an SF alarm:

- After powering the device and/or before initializing master-slave operation: see table below
- After master-slave initialization and in the middle of operation: physical defect of the share bus cable

Possible situations after powering a device or after the configuration has been changed:

Master-slave mode	Share bus cable	Result	Necessary action
off	Disconnected	Normal condition outside of master-slave. Operation unrestricted.	None
off	Connected	SF alarm will occur on every unit connected on the share bus	Remove the share bus cable and clear the alarm
Master	Disconnected	No SF alarm on the master. The master will initialize the MS system, but if at least one slave with SF alarm has been detected, this alarm will be signaled on the master, blocking the DC output from being switched on.	Connect all devices which are supposed to be in the MS system on the share bus and initialize the MS system
Master	Connected	There should be no SF alarm, given that only 1 master and x slaves are in the system	None
Slave	Disconnected	SF alarm occurs and can't be cleared. The master would initialize the system, but the system cannot switch DC on, because the slave reports its SF alarm to the master.	Connect all devices which are supposed to be in the MS system on the share bus and initialize the MS system
Slave	Connected	While booting and later when the master automatically tries to initialize the MS system there should be no SF alarm on all involved devices, given that only 1 master and x slaves are in the system and all have identical firmware versions installed. In case the system is initialized only later on, the slave will signal SF.	None

The alarm must be acknowledged after the cause of the alarm has been removed.

3.4 Manual operation

3.4.1 Powering the device

The device doesn't feature a power switch or something similar on the device body. It's intended for installation into a rack or cabinet that is either powered by a manual main switch or other switching equipment, such as contactors. It means, that no matter if operated as stand-alone unit or part of a master-slave system, there must always be an external power switch.

In case the device is part of a master-slave system, typically installed in a cabinet, then it's common to power all involved units at once via the above mentioned main switch. Depending on the local installation and existing safety devices (RCD etc.), powering multiple units at once could trigger main circuit breakers, RCDs or fuses due to the inrush current. One solution to prevent the fuses from tripping would be to power the single units in the cabinet one by one using the dedicated CB. Another would be to disseminate groups of devices, perhaps 2 or 3, to multiple AC main terminals in the cabinet. In case that the units be powered one by one it's recommended to power the master unit at last.

Once powered, the device indicates the boot phase with LED "Power" on the front being orange. Once it has finished booting and is ready for operation, LED "Power" would change to green.

There is a configurable option which determines the condition of the DC output after power-up. Factory setting here is "Off". Changing it to "Restore" will cause the device to restore the DC output condition from last switch-off, hence either on or off.

In master-slave operation and when the device is being slave, which is the default mode of operation for models of this series, all values and conditions are stored and restored by the master, overwriting the slaves' settings upon initialization.



For the time of the start phase the analog interface can signal undefined statuses on its digital outputs. This must be ignored until the device has finished booting and is ready to work.

3.4.2 Switching the device off

On switch-off, the last DC output condition and the most recent set values are saved. Furthermore, a PF alarm (power failure) will be signaled via LED "Error", but can be ignored.

The DC output is immediately switched off and after a short while fans will shut down and after another few seconds the device will be completely powered off.

3.4.3 Switching the DC output on or off

As long as the device isn't a slave and under remote control by a master unit or by a software via USB interface, the DC output can be manually switched on or off with the pushbutton "On / Off", as located on the front. This is for situations where the device needs to be operated stand-alone or as substitute of a failed or missing master. The same situation also allows for access to all DC output related parameters via the front USB port. The button can also be used to acknowledge device alarms signaled by LED "Error".

Configuration of parameters via one of the USB ports is considered as remote control and is thus described in 3.5.

3.5 Remote control

3.5.1 General

Remote control is essential when operating devices of this series, for example during master-slave. It's furthermore possible to take over remote via any of the built-in control interfaces (USB, analog, Anybus). One of the digital interfaces is the master-slave bus. Important here is the fact that the device can either be under remote via one of the directly accessible interfaces for users or a master unit. It means that if, for example, an attempt were to be made to switch to remote control via the digital interface whilst master-slave mode is running the device would report an error via the digital interface. In the opposite direction, the master unit could not initialize a Slave unit being in USB remote control. In both cases, however, status monitoring and reading of values via any of the USB ports is always possible.

3.5.2 Remote control via digital interface

3.5.2.1 Rear USB

The rear USB port offers the same set of commands as a PS 10000 series device, which is considered to a standard device with its display and knobs. When accessing the PU 10000 series device via this USB port, every feature specified for the series is available, including the option to use the device as master for any other compatible slave device.

Regarding programming and remote control the documentation "Programming guide SCPI & ModBus" is valid for the user, as well as the connected ModBus register list "Modbus_Register_PU10000_KEx.xx+_EN.pdf". Users who purchased the optional function generator license (LIZENZFG, see section «1.9.4 Accessories») will receive an extended ModBus register list with a different name by e-mail after the purchase.

3.5.2.2 Front USB

The main purpose of the front USB port is quick access to the most important DC output related parameters, such as set values and protections. Reading values and status is always possible, setting them only while the device isn't in control by a master device or any of the other interfaces.

Outside of master-slave, the device could be controlled remotely with software **EA Power Control** or from custom applications. In order to do so, a programming documentation is delivered with the device on USB stick.

The number of available commands is restricted on this USB port, but it supports both, SCPI and ModBus RTU communication protocols. As part of the programming documentation, there is an extra ModBus register list named Modbus_Register_PUx10000_Front_HMIx.xx+_EN.pdf.

In the programming guide there is a section for all SCPI commands supported by the various series, as supported via the rear USB port. The front USB port has a reduced set of commands, as shown below. Details about the commands and their use can be found in the programming guide.

*IDN?	[SOURce:]POWER?
*CLS	[SOURce:]POWER:LIMit:HIGH
*RST	[SOURce:]POWER:LIMit:HIGH?
*ESE	[SOURce:]POWER:PROTection[:LEVel]
*ESE?	[SOURce:]POWER:PROTection[:LEVel]?
*ESR	[SOURce:]RESistance
*STB?	[SOURce:]RESistance?
MEASure:[SCALar:]CURRent[:DC]?	[SOURce:]RESistance:LIMit:HIGH
MEASure:[SCALar:]POWER[:DC]?	[SOURce:]RESistance:LIMit:HIGH?
MEASure:[SCALar:]VOLTage[:DC]?	[SOURce:]VOLTage
OUTPut[:STATe]	[SOURce:]VOLTage?
OUTPut[:STATe]?	[SOURce:]VOLTage:LIMit:HIGH
[SOURce:]CURRent	[SOURce:]VOLTage:LIMit:HIGH?
[SOURce:]CURRent?	[SOURce:]VOLTage:LIMit:LOW
[SOURce:]CURRent:LIMit:HIGH	[SOURce:]VOLTage:LIMit:LOW?
[SOURce:]CURRent:LIMit:HIGH?	[SOURce:]VOLTage:PROTection[:LEVel]
[SOURce:]CURRent:LIMit:LOW	[SOURce:]VOLTage:PROTection[:LEVel]?
[SOURce:]CURRent:LIMit:LOW?	STATus:OPERation?
[SOURce:]CURRent:PROTection[:LEVel]	STATus:QUEStionable?
[SOURce:]CURRent:PROTection[:LEVel]?	SYSTem:ALARm:ACTion:PFAil
[SOURce:]POWER	SYSTem:ALARm:ACTion:PFAil?

SYSTem:ALARm:COUNT:OCURrent?	SYSTem:CONFIg:UCD
SYSTem:ALARm:COUNT:OPOWer?	SYSTem:CONFIg:UCD?
SYSTem:ALARm:COUNT:OTEMperature?	SYSTem:CONFIg:UCD:ACTion
SYSTem:ALARm:COUNT:OVOLTage?	SYSTem:CONFIg:UCD:ACTion?
SYSTem:ALARm:COUNT:PFail?	SYSTem:CONFIg:USER:TEXT
SYSTem:COMMunicate:TIMeout?	SYSTem:CONFIg:USER:TEXT?
SYSTem:CONFIg:MODE	SYSTem:CONFIg:UVD
SYSTem:CONFIg:MODE?	SYSTem:CONFIg:UVD?
SYSTem:CONFIg:OCD	SYSTem:CONFIg:UVD:ACTion
SYSTem:CONFIg:OCD?	SYSTem:CONFIg:UVD:ACTion?
SYSTem:CONFIg:OCD:ACTion	SYSTem:DEVIce:CLAss?
SYSTem:CONFIg:OCD:ACTion?	SYSTem:ERRor:ALL?
SYSTem:CONFIg:OPD	SYSTem:ERRor:NEXT?
SYSTem:CONFIg:OPD?	SYSTem:ERRor?
SYSTem:CONFIg:OPD:ACTion	SYSTem:LOCK
SYSTem:CONFIg:OPD:ACTion?	SYSTem:LOCK?
SYSTem:CONFIg:OUTPut:RESTore	SYSTem:LOCK:OWNer?
SYSTem:CONFIg:OUTPut:RESTore?	SYSTem:NOMinal:CURRent?
SYSTem:CONFIg:OVD	SYSTem:NOMinal:POWer?
SYSTem:CONFIg:OVD?	SYSTem:NOMinal:RESistance:MAXimum?
SYSTem:CONFIg:OVD:ACTion	SYSTem:NOMinal:RESistance:MINimum?
SYSTem:CONFIg:OVD:ACTion?	SYSTem:NOMinal:VOLTage?

3.5.2.3 Programming

Programming details about the communication protocols etc. are to be found in the documentation “Programming Guide ModBus & SCPI” which is supplied on the included USB stick or is available as download from the manufacturer’s website.

3.5.3 Interface monitoring

Interface monitoring is a functionality with the goal to monitor (or supervise) the digital communication line between the device and a superior control unit, such as a PC or PLC, and to ensure that the device wouldn’t continue working uncontrolled in case the communication line fails. A failing line can mean that it’s either physically interrupted (damaged cable, bad contact, cable pulled) or the interface port inside the device hangs. The monitoring can only be configured via the Settings app of **EA Power Control**.

While monitoring is activated, it would only be valid for the one interface being used for remote control, except for the situation when the device is a slave unit within a master-slave system. Then only the master has active interface monitoring. However, the connection between master and slaves is also supervised and in case of interruption on that particular connection line or other malfunctions, the device would go into the alarm state of MSP (master-slave protection).

The monitoring is based on a user-definable timeout which would run out if not at least one message is sent to the device within the given time frame. After every message, the timeout would start again and reset with the next message coming. In case it runs out, following reaction of the device is defined:

- Exit remote control
- Should the DC output be switched on, it either switches it off or remains on, depending on what’s determined by the **EA Power Control** setting **Other-> DC input/output state after remote**

Notes for the operation:

- The timeout of the monitoring can be changed anytime via remote control; the new value would only be valid after the current timeout has elapsed
- The interface monitoring doesn’t deactivate the Ethernet connection timeout, so these two timeouts can overlap

3.5.4 Remote control via the analog interface

3.5.4.1 General

The built-in, galvanically isolated, 15-pole analog interface (below referenced in short form as **AI**) is located on the rear side of the device and provides the following possibilities:

- Remote control of current, voltage, power and internal resistance
- Remote status monitoring (CC/CP, CV, DC output)
- Remote alarm monitoring (OT, OVP, OCP, OPP, PF)
- Remote monitoring of actual values
- Remote on/off switching of the DC output

Setting the set values of voltage, current and power via the analog interface must always be done concurrently. It means, that for example the voltage can't be adjusted via the AI and current and power set by digital line, or vice versa. The internal resistance set value can additionally be adjusted.

The OVP set value and other alarm thresholds can't be set via the AI and therefore must be adapted to the given situation before the AI is taking over control. Analog set values can be supplied from an external voltage source or can be derived from the reference voltage on pin 3.

The AI can be operated in the common voltage ranges 0...5 V and 0...10 V, both representing 0...100% of the rated value. The selection of the voltage range can be done via a few settings available as ModBus register, SCPI command or in the Settings app of **EA Power Control**. The reference voltage sent out from pin 3 (VREF) will be adapted accordingly:

Selected setting **5 V**: Reference voltage = 5 V, 0...5 V set value signal for VSEL, CSEL, PSEL and RSEL correspond to 0...100% nominal value, 0...100% actual values correspond to 0...5 V at the actual value outputs CMON and VMON.

Selected setting **10 V**: Reference voltage = 10 V, 0...10 V set value signal for VSEL, CSEL, PSEL and RSEL correspond to 0...100% nominal values, 0...100% actual values correspond to 0...10 V at the actual value outputs CMON and VMON.

All set values are always additionally limited to the corresponding adjustment limits (U-max, I-max etc.), which would clip setting excess values for the DC output.

Before you begin, please read these important notes about the use of the interface:



After powering the device and during the start phase the AI signals undefined statuses on the output pins. Those must be ignored until is ready to work.

- Analog remote control of the device must be activated by switching pin REMOTE (5) first. Only exception is pin REM-SB, which can be used independently
- Before the hardware is connected that will control the analog interface, it shall be checked that it can't provide voltage to the pins higher than specified (table in 3.5.4.3)
- Set value inputs, such as VSEL, CSEL, PSEL and RSEL, if R mode is activated, must not be left unconnected (i.e. floating) during analog remote control. In case any of the set values isn't used for adjustment, it can be tied to a defined level or connected to pin VREF (solder bridge or different)

3.5.4.2 Acknowledging device alarms

In case of a device alarm occurring during remote control via analog interface, the DC output will be switched off the same way as in digital remote control. The device would indicate an alarm (see «3.6 Device alarm handling») on the front with LED "Error" and also signal it on the analog interface. Which alarms are eventually signaled can be set up in the device configuration via remote control (commands or **EA Power Control**).

The alarms MSP, OVP, OCP and OPP have to be acknowledged (also see 3.6). Acknowledgment is done with pin REM-SB switching the DC output off and on again, that's means a HIGH-LOW-HIGH edge (min. 50ms for LOW), given the default logical level is set for REM-SB.

The same is required for PF and OT in case the related **EA Power Control** settings **Other -> DC input/output state after PF alarm** or **Other -> DC input/output state after OT alarm** are set to **Off**.

3.5.4.3 Analog interface specification

Pin	Name	Type ⁽¹⁾	Description	Default levels	Electrical specifications
1	VSEL	AI	Set voltage value	0...10 V or. 0...5 V correspond to 0..100% of U_{Nom}	Accuracy 0-5 V range: < 0.4% ⁽⁵⁾ Accuracy 0-10 V range: < 0.2% ⁽⁵⁾
2	CSEL	AI	Set current value	0...10 V or. 0...5 V correspond to 0..100% of I_{Nom}	Input impedance R_i >40 k...100 k
3	VREF	AO	Reference voltage	10 V or 5 V	Tolerance < 0.2% at $I_{max} = +5$ mA Short-circuit-proof against AGND
4	DGND	POT	Digital ground		For control and status signals
5	REMOTE	DI	Switches between manual and remote control	Remote = LOW, $U_{Low} < 1$ V Manual = HIGH, $U_{High} > 4$ V Manual, if pin not wired	Voltage range = 0...30 V $I_{Max} = -1$ mA at 5 V U_{Low} to HIGH typ. = 3 V Rec'd sender: Open collector against DGND
6	ALARMS 1	DO	Overheating or power fail alarm	Alarm = HIGH, $U_{High} > 4$ V No alarm = LOW, $U_{Low} < 1$ V	Quasi open collector with pull-up against V_{cc} ⁽²⁾ With 5 V on the pin max. flow +1 mA $I_{Max} = -10$ mA at $U_{CE} = 0,3$ V $U_{Max} = 30$ V Short-circuit-proof against DGND
7	RSEL	AI	Set internal resistance value	0...10 V or. 0...5 V correspond to 0..100% of R_{Max}	Accuracy 0-5 V range: < 0.4% ⁽⁵⁾ Accuracy 0-10 V range: < 0.2% ⁽⁵⁾
8	PSEL	AI	Set power value	0...10 V or. 0...5 V correspond to 0..100% of P_{Nom}	Input impedance R_i >40 k...100 k
9	VMON	AO	Actual voltage	0...10 V or. 0...5 V correspond to 0..100% of U_{Nom}	Accuracy 0-5 V range: < 0.4% ⁽⁵⁾ Accuracy 0-10 V range: < 0.2% ⁽⁵⁾
10	CMON	AO	Actual current	0...10 V or. 0...5 V correspond to 0..100% of I_{Nom}	at $I_{Max} = +2$ mA Short-circuit-proof against AGND
11	AGND	POT	Analog ground		For xSEL, xMON and VREF
12	R-ACTIVE	DI	R mode on / off	Off = LOW, $U_{Low} < 1$ V On = HIGH, $U_{High} > 4$ V On, if pin not wired	Voltage range = 0...30 V $I_{Max} = -1$ mA bei 5 V U_{Low} to HIGH typ. = 3 V Rec'd sender: Open collector against DGND
13	REM-SB	DI	DC output OFF (DC output ON) (ACK alarms ⁽⁴⁾)	Off = LOW, $U_{Low} < 1$ V On = HIGH, $U_{High} > 4$ V On, if pin not wired	Voltage range = 0...30 V $I_{Max} = +1$ mA at 5 V Rec'd sender: Open collector against DGND
14	ALARMS 2	DO	Overvoltage alarm Overcurrent alarm Overpower alarm	Alarm = HIGH, $U_{High} > 4$ V No alarm = LOW, $U_{Low} < 1$ V	Quasi open collector with pull-up against V_{cc} ⁽²⁾ With 5 V on the pin max. flow +1 mA $I_{Max} = -10$ mA at $U_{CE} = 0,3$ V, $U_{Max} = 30$ V Short-circuit-proof against DGND
15	STATUS ⁽³⁾	DO	Constant voltage regulation active DC output	CV = LOW, $U_{Low} < 1$ V CC/CP/CR = HIGH, $U_{High} > 4$ V Off = LOW, $U_{Low} < 1$ V On = HIGH, $U_{High} > 4$ V	

(1) AI = Analog Input, AO = Analog Output, DI = Digital Input, DO = Digital Output, POT = Potential

(2) Internal V_{cc} approx. 10 V

(3) Only one of both signals possible

(4) Only during remote control

(5) The error of an analog input/output adds to the general error of the related value on the DC output of the device

3.5.4.4 Resolution

The analog interface is internally sampled and processed by a digital microcontroller. This causes a limited resolution of analog steps. The resolution is the same for set values (VSEL etc.) and actual values (VMON/CMON) and is 26214 for 0...100% when working with the 10 V range. In the 5 V range this resolution halves. Due to tolerances, the truly achievable resolution can be slightly lower.

3.5.4.5 Overview of the Sub-D Socket

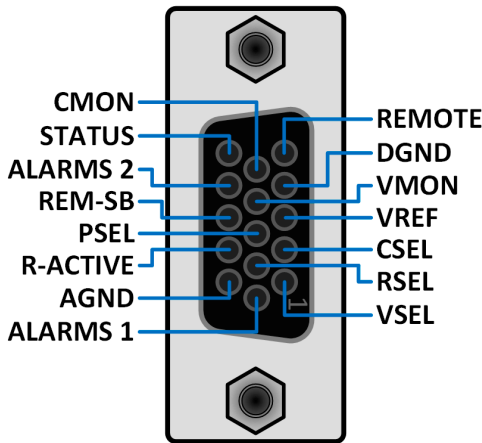

3.5.4.6 Simplified diagram of the pins

	<p>Digital Input (DI)</p> <p>It requires to use a switch with low resistance (relay, switch, circuit breaker etc.) in order to send a clean signal to the DGND.</p> <p>A digital output of an IC or PLC may not be able to pull the input down, if not of type "open collector".</p>		<p>Analog Input (AI)</p> <p>High resistance input (impedance >40 kΩ) for an operation amplifier circuit.</p>
	<p>Digital Output (DO)</p> <p>A quasi open collector, realized as high resistance pull-up against the internal supply. In condition LOW it can't drive any load, only sink small current, as shown in the diagram with a relay as example.</p>		<p>Analog Output (AO)</p> <p>Output from an operation amplifier circuit, low impedance. See specifications table above.</p>

3.5.4.7 Application examples

a) Switching the DC output with pin REM-SB

A digital output, e.g. from a PLC, may be unable to cleanly pull down the pin as it may not be of low enough resistance. Check the specification of the controlling application. Also see pin diagrams above.

In remote control, pin REM-SB is used to switch the DC output of the device on and off. This function is also available without remote control being active and can on the one hand block the DC output from being switched on in manual or digital remote control and on the other hand the pin can switch the DC output on or off, but not standalone. See below at **Remote control has not been activated**.

REM-SB cannot serve as a safety stop switch to securely deactivate the DC output in case of emergency! For that an external emergency stop system is required.

It's recommended that a low resistance contact such as a switch, relay or transistor is used to switch the pin to ground (DGND).

Following situations can occur:

- Remote control has been activated**

During remote control via analog interface, only pin REM-SB determines the states of the DC output, according to the level definitions in 3.5.4.3. The logical function and the default levels can be inverted by a setting **Analog interface > REM-SB level** in the Settings app of **EA Power Control**, via ModBus register or SCPI command.

If the pin is unconnected or the connected contact is open, the pin will be HIGH. With the setting "Analog interface -> REM-SB level" being set to "Normal", it requests to switch the DC output on. So when activating remote control, the DC output will instantly switch on.

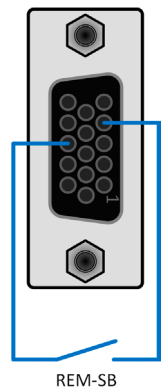

• **Remote control isn't active**

In this mode of operation pin REM-SB can serve as lock, preventing the DC output from being switched on by any means. This results in following possible situations:

DC output	+	Level on pin REM-SB	+	Parameter „REM-SB level“	→ Behavior
is off	+	HIGH	+	Normal	→ The DC output isn't locked. It can be switched on by pushbutton "On/Off" (front panel) or via command from digital interface.
		LOW	+	Inverted	
	+	HIGH	+	Inverted	→ The DC output locked. It can't be switched on by pushbutton "On/Off" (front panel) or via command from digital interface. When trying to switch on the device would simply not react.
		LOW	+	Normal	

In case the DC output is already switched on, toggling the pin will switch the DC output off, similar to what it does in analog remote control:

DC output	+	Level on pin REM-SB	+	Parameter „REM-SB level“	→ Behavior
is on	+	HIGH	+	Normal	→ The DC output remains on, nothing is locked. It can be switched on or off by pushbutton or digital command.
		LOW	+	Inverted	
	+	HIGH	+	Inverted	→ The DC output will be switched off and locked. Later it can be switched on again by toggling pin REM-SB.
		LOW	+	Normal	

b) Remote control of current and power

Requires remote control to be activated (Pin REMOTE = LOW)

The set values PSEL and CSEL are generated from, for example, the reference voltage VREF, using potentiometers for each. Hence the power supply can selectively work in current limiting or power limiting mode. According to the specification of max. 5 mA load for the VREF output, potentiometers of at least 10 kΩ must be used.

The voltage set value VSEL is directly connected to VREF and will thus be permanently 100%. R-ACTIVE is tied to DGND, so resistance mode is off.

If the control voltage is fed in from an external source it's necessary to mind the input voltage range for set values (0...5 V or 0...10 V).



Use of the input voltage range 0...5 V for 0...100% set value halves the effective resolution.

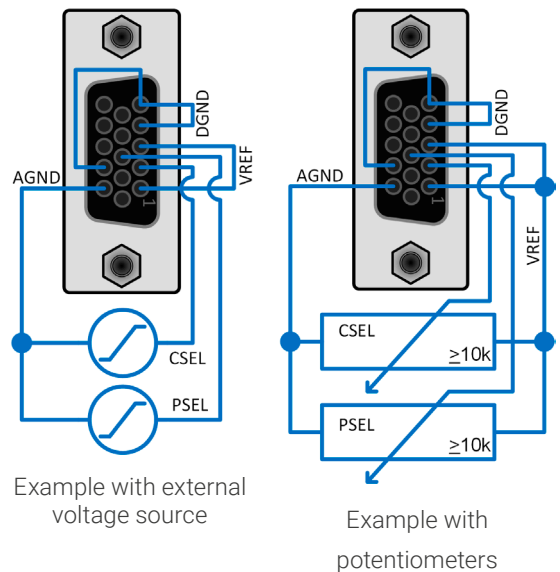

c) Reading actual values

The AI provides the actual values on the DC output as current and voltage monitor. These can be read using a standard multimeter or an analog input of a PLC etc.

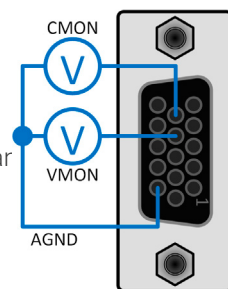

3.6 Device alarm handling

A device alarm incident will usually lead to DC output switch-off and LED "Error" on the front panel will light up to make the user aware. An alarm must always be acknowledged, which would also clear the indication.

► **How to acknowledge an alarm on the control panel (during manual control)**

1. In case the DC output is switched off and the LED "Error" is lit, use button "On / Off".
2. The LED should go off and with another push on "On / Off", the DC output could be switched on again. If the LED remains lit, the alarm cause could still be present.

► **How to acknowledge an alarm during digital remote control**

1. When using a ModBus based interface by writing a coil, specifically register 411. When using SCPI with the standard error query SYST:ERR:ALL?.

► **How to acknowledge an alarm during analog remote control**

1. See «3.5.4.2 Acknowledging device alarms».

Some device alarms are configurable via ModBus register, SCPI command or in **EA Power Control**:

Short	Long	Description	Range
OVP	OverVoltage Protection	Triggers an alarm as soon as the DC output voltage reaches the OVP threshold. The DC output will be switched off.	$0 V \dots 1.1 * U_{Nom}$
OCP	OverCurrent Protection	Triggers an alarm as soon as the DC output current reaches the OCP threshold. The DC output will be switched off.	$0 A \dots 1.1 * I_{Nom}$
OPP	OverPower Protection	Triggers an alarm as soon as the DC output power reaches the OPP threshold. The DC output will be switched off.	$0 W \dots 1.1 * P_{Nom}$

These device alarms can't be configured and are based on hardware:

Short	Long	Description
PF	Power Fail	<p>AC supply over- or undervoltage. Triggers an alarm in case the AC supply is out of specification or when the device is cut from AC supply. The DC output will be switched off. The condition of the DC output after a temporary PF alarm can be determined by the EA Power Control setting Other -> DC input/output state after PF alarm (also available as ModBus register and SCPI command).</p> <p> <i>Acknowledging a PF alarm during runtime can only occur approx. 15 seconds after the cause of the alarm has gone. Switching the DC output on again requires another approx. 5 seconds of waiting time.</i></p>
OT	OverTemperature	Triggers an alarm if the internal temperature reaches a certain limit. The DC output will be switched off which could be only temporarily, depending on the EA Power Control setting Other -> DC input/output state after OT alarm (also available as ModBus register and SCPI command).
MSP	Master-Slave Protection	Triggers an alarm if the device is master in a master-slave system and loses contact to at least one slave. The same occur if the device is slave and not yet initialized by the master. The DC output will be switched off. The alarm can be cleared by reinitializing the MS system or deactivating master-slave mode.
SF	Share Bus Fail	Can occur in situations where the share bus signal is damped too much due to wrong or damaged (short-circuit) BNC cables or simply when at least one of the share bus connectors is wired to another device while the device signaling the alarm isn't (yet) configured for master-slave operation. For details also see 3.3.6.

3.7 Other applications

3.7.1 Parallel operation in master-slave (MS)

The primary and intended form of operation for a PU 10000 series device is as slave in a master-slave system.

Multiple devices of same device type, i. e. power supply, electronic load or bidirectional, can be connected in parallel in order to create a system with higher total current and hence higher power. For parallel operation in master-slave mode the units are usually connected on their DC outputs, their share bus and their master-slave bus, which is a digital bus that makes the system work as one big unit regarding adjusted values, actual values and status.

The share bus is intended to balance the units dynamically in their voltage on the DC output, i.e. in CV mode, especially if the master unit runs a function generator, if featured there. In order for this bus to work correctly, at least the DC minus poles of all units have to be connected, because DC minus is the reference for the share bus.

Principle view (without load):

Share bus connection

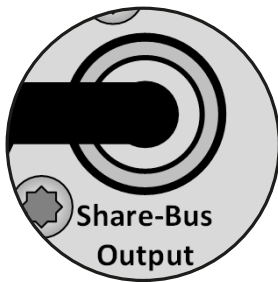

Master-slave bus

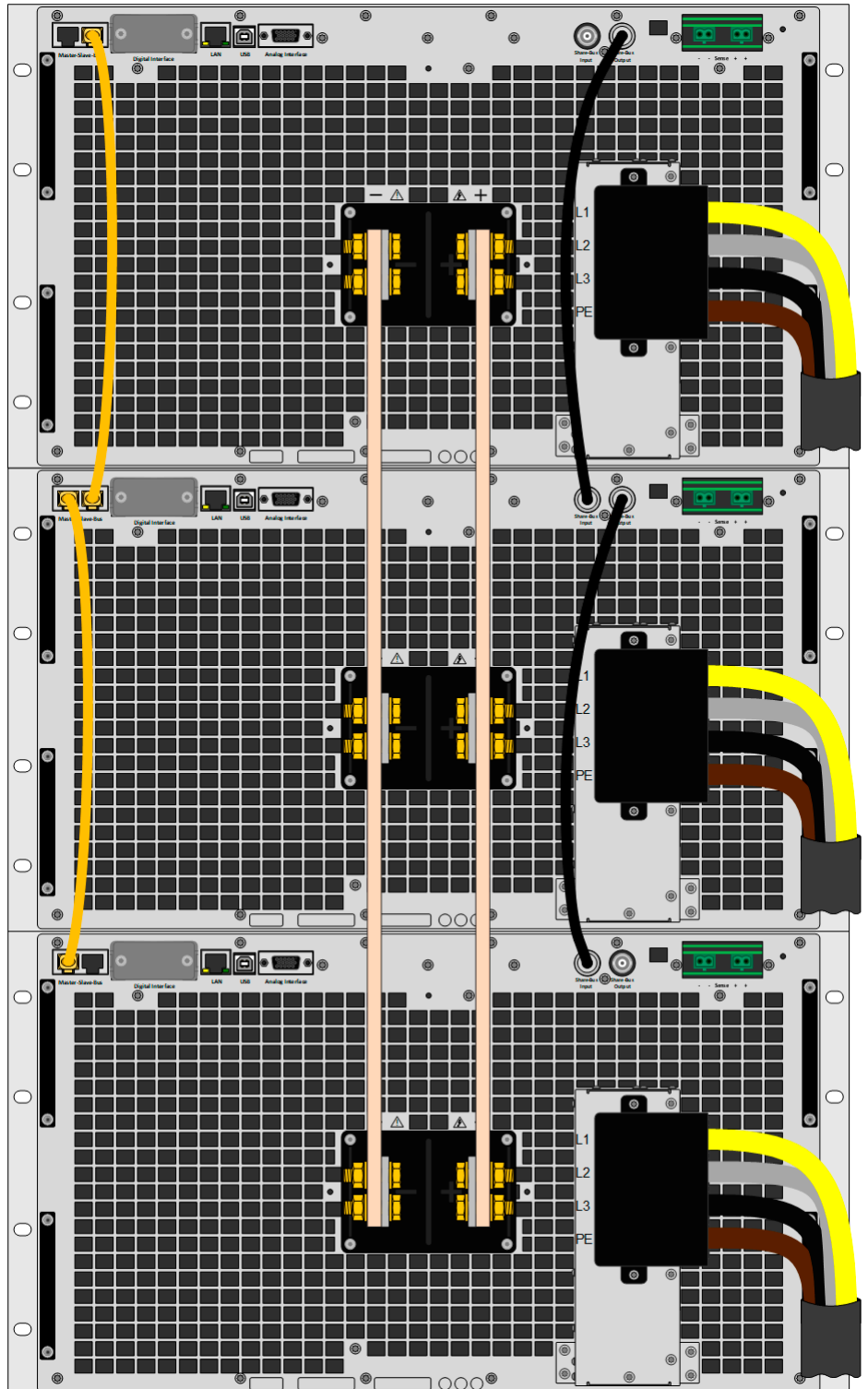

3.7.1.1 Restrictions & requirements

Compared to normal operation of a single device, master-slave operation has some restrictions and requirements:

- The MS system reacts partly different in alarm situations (see below in 3.7.1.8)
- Connecting the share bus is mandatory
- Though the share bus makes the system react as dynamic as possible, it's still not as dynamic as single unit operation
- Connection to identical models from other series is supported, but limited to series PSI 10000 and PS 10000 which can serve as master or slave units

3.7.1.2 Wiring the DC outputs

The DC output of every unit in the parallel operation is connected with correct polarity to the next unit, using cables or copper bars with a cross section according to the total system current and with short as possible length, so their inductance is as low as possible.

3.7.1.3 Wiring the share bus

The share bus is essential for master-slave operation. It's wired from unit to unit with standard BNC cables (coaxial, 50 Ω type), with a length of 0.5 m (1.64 ft) or similar. Both BNC sockets are internally wired and are not specifically input or output. The labeling is only for orientation.



- A max. of 64 units can be connected via share bus.
- Depending on the share bus being connected or not and the configuration of master-slave mode, the device might show an SF alarm (for details see «3.3.6 Share bus fail»)

3.7.1.4 Wiring and set-up of the digital master-slave bus

The master-slave connectors are built-in and can be connected via network cables (\geq CAT3, patch cable). After this, MS can be configured manually (recommended) or by remote control. The following applies:

- A maximum of 64 units can be connected via the bus: 1 master and up to 63 slaves.
- Connection only between devices of same kind, i.e. like power supply to power supply; connection of different power classes is allowed and supported, see below in 3.7.1.5
- Units at the end of the bus must be terminated (see below for more information), else the master-slave initialization will fail



The master-slave bus must **not** be wired using crossover cables!

Later operation of the MS system implies:

- The master unit provides summed up actual values and status of the entire system via remote control query, but not over every interface. It means, as an example, only when using SCPI a 300 kW system is capable of returning the queried actual power as "300.0kW", but on all other interfaces this value would be a per cent value of the system's total power and would have to be correctly translated by remote control software
- The ranges for setting the values, adjustment limits, protections (OVP etc.) of the master are adapted to the total number of units
- Slaves are no operable as long as being controlled by the master
- Slaves which haven't yet been initialized by the master will show the MSP alarm with LED "Error". The same alarm is signaled upon MS bus errors

3.7.1.5 Mixed systems

As mixed systems following is understood:

- Different power classes like 15 kW, 30 kW or 600 kW within one master-slave system (requires at least firmware KE 3.02)
- Different series, specifically PS 10000 series in connection with PU 10000 series (requires at least firmware KE 3.02)

When connecting devices with different feature sets it makes sense to select the one with the best configuration as master. Combining different power classes can have an unexpected side effect, such that the resulting total power after initialization isn't the expected one, but lower. This depends on what unit with what power class has been picked as master. In such a situation the golden rule is: always select the master from within the units with the highest power rating.

Example: you want to connect a 60 kW unit and a 3kW unit in order to achieve 63 kW. Generally, the voltage rating must match, but current and power rating can be different. The power rating then is decisive. When using the 3 kW unit as master, the total system power will only be 51 kW, which is even less than the single 60 kW unit can provide. However, when switching to the 60 kW unit as master, the system will result in 63 kW total power.

Compatibility of 10000 series to each other, no matter what power class (date 06-2023):

	PS	PSI	PU	ELR	PUL	PSB	PSBE	PUB
PS	X	X	X (*)	-	-	-	-	-
PSI	X	X	X (*)	-	-	-	-	-
PU	X (*)	X (*)	X (*)	-	-	-	-	-
ELR	-	-	-	X	X (*)	-	-	-
PUL	-	-	-	X (*)	X (*)	-	-	-
PSB	-	-	-	-	-	X	X	X (*)
PSBE	-	-	-	-	-	X	X	X (*)
PUB	-	-	-	-	-	X (*)	X (*)	X (*)

(* Requires at least firmware KE 3.06 on all involved units)

3.7.1.6 Configuring the master-slave operation

Master-slave configuration for a system that shall not be changed anymore afterwards, has to be done only once. The devices will store their settings and after every start the master will automatically try to initialize all slaves. Should the master be one with a display, configuration and initialization can be done manually, using the touch screen.

Otherwise, the setup is done either via custom software and ModBus/SCPI commands or **EA Power Control**. Given that the master-slave system is already properly wired and all units are running, the last step is master-slave configuration.

► How to configure a unit as slave or master for master-slave operation using EA Power Control

1. Connect the device to the PC using either the front USB or rear USB port
2. Start **EA Power Control** and let it find the device. In case, several devices are connected to the PC, select the proper one and drag its symbol onto the **Settings** app.
3. In the Settings app, navigate to group **Master-slave** and set **Master-slave mode** to **Slave** or **Master**.
4. Correctly set termination. The actual bus termination is done with internal electronic switches which are controlled via commands. This can be done as part of setting up every unit as master or slave, but should be done before the master is going to be set as such, because doing so immediately triggers a bus initialization. In the settings group **Master-slave** the termination resistors for BIAS and for the bus itself (TERM, see figure to the right) can be set separately. Termination setting for the units on the MS bus:

Device position	Termination setting(s)
Master (at end of bus)	Bias resistor = On + Termination resistor = On
Master (central in bus)	Bias resistor = On
Slave (at end of bus)	Termination resistor = On
Slave (central in bus)	Bias resistor = Off + Termination resistor = Off

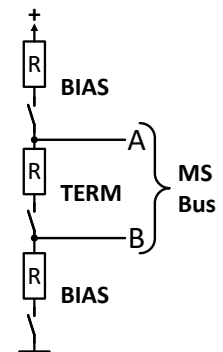

5. Save settings and leave the app.



As long as MS mode remains activated, the initialization process of the master-slave system will be repeated each time the master unit is powered. The initialization can also be repeated manually anytime via the Settings app in EA Power Control, in group "Master-Slave", or custom software using master-slave operation related commands.

3.7.1.7 Operating the master-slave system

After successful configuration and initialization of the master and slave units, the focus is on the master. In case the master is a model from this series, it cannot show its master status on the front via LEDs, but the status of the MS operation can be queried anytime from the master using **EA Power Control** or custom software. Masters with display can show all status on the display as well.

From now on the slaves can no longer be controlled manually or remotely, neither via the analog nor via digital interfaces. If needed, they could be monitored via these interfaces by reading actual values and status.

The master unit will reconfigure after initialization and all set values are reset. Towards a controlling software, the master can represent all its values in readable form and adapted to what the system now is defined for, but only when using SCPI or perhaps LabVIEW, which limits the choice of interfaces to LAN or USB. Depending on the number of units, the adjustable current and power range will multiply, while the resistance range will decrease. With any of the other available interfaces, the translation of values is to be done by the software.

Following applies generally:

- The master-slave system can be treated like a standalone unit
- The master shares the set values etc. across the slaves and controls them
- The master is remotely controllable via the analog or digital interfaces
- All settings for the set values U, I, P and R on the master, plus also all related values from supervision, limits etc. should be adapted to the new total values
- All initialized slaves will reset any limits (U_{Min} , I_{Max} etc.), supervision thresholds (OVP, OPP etc.) to default values, so these don't interfere the control by the master. As soon as these values are modified on the master, they are transferred 1:1 to the slaves. Later, during operation, it might occur that a slave causes an alarm earlier than the master, due to imbalanced current or slightly faster reaction.
- If one or more slaves report a device alarm, it will also be signaled on the master via LED "Error" and must be acknowledged on the master, no matter with what of the available ways, so that the slave(s) can continue operation. Since an alarm usually causes the DC outputs to switch off and can only reinstate the on/off condition automatically after PF or OT alarms, where the reaction to the alarms is configurable, action from an operator or a remote control software may become necessary in such a situation.
- Loss of connection to any slave will result in shutdown of all DC outputs as a safety measure and the units will report this situation on their front panels by the LED "Error" lighting up, as well as master will provide a readable alarm status MSP ("master-slave protection"). Then the MS system has to be re-initialized, either with or without prior re-establishment of the connection to the disconnected unit(s).
- All units, even the slaves, can be externally shut down on their DC outputs using the REM-SB pin of the analog interface. This can be used as some kind of "emergency off" where usually a contact (maker or breaker) is wired to this pin on all units in parallel.

3.7.1.8 Alarms and other problem situations

Master-slave operation, due to the connection of multiple units and their interaction, can cause additional problem situations which wouldn't occur when operating individual units. For such occurrences the following regulations have been defined:

- Generally, if the master loses connection to any slave, it will generate an MSP (master-slave protection) alarm, pop up a message on the screen (if the master is one with display) and switch off its DC output. The slaves will fall back to single operation mode, but also switch off their DC output. The MSP alarm can be deleted by either initializing the master-slave system again or deactivating master-slave mode which requires to connect to every single slave. Re-initialization can either be done in the MSP alarm pop-up screen (if the master is with display) or in the MENU of the master (if the master is with display) or via remote control.
- If one or more slave units are cut from AC supply (blackout, supply undervoltage) and come back later, they're not automatically initialized and included again in the MS system. Then the init has to be repeated.
- If the master unit is cut from AC supply (fuse tripped, blackout) and comes back later, it will automatically try to initialize the MS system again, finding and integrating all active slaves. In such a case, MS can be restored automatically.
- If multiple units are defined as master the master-slave system can't be initialized.
- Should the master report the initialization status as failed and the status message says "Different firmwares or models detected" (if the master is with display), then at least one unit in the MS system either has an older hardware version or there are different firmware versions installed in the units. The latter can be fixed by checking what's installed on the units and then adapt.

In situations where one or multiple units generate a device alarm like OVP etc. following applies:

- Any alarm of a slave is indicated on the slave's front panel and on the master's front panel (with or without display)
- If multiple alarms happen simultaneously, the master only indicates the most recent one. In this case, the particular alarms could be read from the slave units via digital interface.
- All units in the MS system supervise their own values regarding overvoltage, overcurrent and overpower and in case of alarm they report the alarm to the master. In situations where the output current is probably not balanced well between the units, it can occur that one unit generates an OCP alarm though the global OCP limit of the MS system was not reached. The same can occur with the OPP alarm.

3.7.2 Series connection

Series connection of two or more devices is permissible, because these are power supplies, i. e. sources. However, for reasons of safety and insulation, following restrictions apply:



- Both, the negative (DC-) and positive (DC+) output poles, are connected to PE via type X capacitors. This entails that none of the DC minus poles of any unit in the series connection must have a potential against ground (PE) higher than specified in the technical data! The maximum allowed potential shift varies from model to model and is different for DC plus and DC minus
- Remote sensing must not be used!
- Series connection is only allowed between devices of the same kind, i.e. power supply with power supply, and ideally same ratings where especially the current rating should match

Series connection isn't supported in master-slave mode, because master-slave is for parallel connection only. Without master-slave all units would be controlled separately regarding their set values and DC output status etc., no matter if a digital or analog interface is used.

Analog interfaces on devices in serial connection can be wired in parallel, because they are galvanically isolated. It's also allowed to ground the GND pins of the analog interfaces connected in parallel, which may happen automatically when connecting them to a controlling device such as a PC where grounds are directly tied to PE.

3.7.3 SEMI F47

SEMI F47 (the SEMI comes from semiconductor) is a specification that demands a device to continue working without interruption in case of a power failure in form of an AC supply undervoltage (here: sag) of max. -50% of the rated line voltage with a max. duration of 1.7 seconds. From hardware revision 02 (see type label for Rev_02_yyy_xxxxxxx) and firmware KE 3.06 this is available in PU 10000 devices. Retrofit for devices with an older hardware revision upon request. When activated, the device will permanently reduce the available DC input power to 50%, here 30000 W.

SEMI F47 specifies a AC supply voltage sag in steps of increasing voltage:

Sag of	Duration at 50 Hz	Duration at 60 Hz	Duration in seconds
50%	10 cycles	12 cycles	0.2
30%	25 cycles	30 cycles	0.5
20%	50 cycles	60 cycles	1 s

3.7.3.1 Restrictions

- The activated feature requires a decreased maximum DC power in order to keep the currently adjusted output values in the moment of the AC voltage sag; therefore, SEMI F47 is considered as a sort of power derating. This reduced power rating is activated and deactivated together with SEMI F47.

3.7.3.2 Adjustments

- SEMI F47 can only be activated/deactivated via digital interface, by remote control command and by using our software **EA Power Control** with its **Settings app** in tab **"Other"**, unless blocked due to the current device state. After activation or deactivation in **EA Power Control**, run a scan for devices, so the software reads the changed maximum power rating from the device.

3.7.3.3 Application

The feature can be activated at any time. Directly after activating it somewhen during normal operation, the device will instantly reduce the max. available power, as well as adjust the power set values, should the current one be higher than the new maximum. When deactivating the feature it goes vice versa, only the power set values remain unaltered then. Due to the fact that the setting is stored beyond shutting down the device, it could directly boot into SEMI F47 mode during next start.

If later a voltage sag occurs, the level of sag or the duration decides whether the device continues its operation without switching the DC output off or if it would show a **PF** (power fail) alarm. Without SEMI F47 being activated, the PF alarm would appear immediately while with activated SEMI F47 it's delayed for at least 2 seconds or will never occur. In this case, the device wouldn't show any reaction to the sag, nor register the occurrence in any form.

4. Service and maintenance

4.1 Maintenance / cleaning

The device needs no maintenance. Cleaning may be needed for the internal fans, the frequency of cleanse is depending on the ambient conditions. The fans serve to cool the components which are heated by the inherent power loss. Heavily dirt filled fans can lead to insufficient airflow and therefore the DC output would switch off too early due to overheating or possibly lead to defects.

In case there is requirement for such a maintenance, please contact us.

4.1.1 Battery replacement

The device contains a Lithium cell battery of type CR2032, which is placed on the so-called KE board that is mounted to the right-hand side wall (when looking from the front) of the device. The battery is specified for a life span of at least 5 years, but due to ambient condition, especially temperature, this span could be lower. The battery is used to buffer the internal real-time clock and if it becomes necessary to replace the battery, it can be done on location by a qualified person while maintaining typical ESD precautionary measures. The KE board would have to be loosened and lifted up carefully to access the battery.

4.2 Fault finding / diagnosis / repair

If the equipment suddenly performs in an unexpected way, which indicates a fault, or it has an obvious defect, this can't and must not be repaired by the user. Contact the supplier in case of suspicion and elicit the steps to be taken.

It will then usually be necessary to return the device to the supplier (with or without guarantee). If a return for checking or repair is to be carried out, ensure that:

- the supplier has been contacted and it's clarified how and where the equipment should be sent.
- the device is in fully assembled state and in suitable transport packaging, ideally the original packaging.
- optional extras such as an interface module is included if this is in any way connected to the problem.
- a fault description in as much detail as possible is attached.
- if shipping destination is abroad, the necessary customs papers are attached.

4.2.1 Firmware updates



Firmware updates should only be installed when they can eliminate existing bugs in the firmware in the device or contain new features.

The firmware of the control panel (HMI), of the communication unit (KE) and the digital controller (DR), if necessary, is updated via the [rear side](#) USB port. For this the software **EA Power Control** is needed which is included with the device or available as download from our website together with the firmware update, or upon request.

However, be advised not to install updates promptly. Every update includes the risk of an inoperable device or system. We recommend to install updates only if...

- an imminent problem with your device can be solved directly, especially if we suggested to install an update during a support case
- a new feature has been added which you definitely want to use. In this case, the full responsibility is transferred to you.

Following also applies in connection with firmware updates:

- Simple changes in firmwares can have crucial effects on the application the devices are use in. We thus recommend to study the list of changes in the firmware history very thoroughly.
- Newly implemented features may require an updated documentation (user manual and/or programming guide, as well as LabView VIs), which is often delivered only later, sometimes significantly later

4.2.2 Trouble-shooting device problems

Problem situation	Possible hazard	Probability	Safety measures to take by the operator	Residual risk
A voltage source with reversed polarity has been connected to the DC terminal	Damage of the internal secondary power stage	Low	With all application that require to connect an external source to the device, especially if the source is a battery, attach an extra warning sign onto the device which instructs the user to be extra careful, watching the polarity. As an additional measure include fuses in line with the DC cables which could attenuate or even prevent damage to the device.	Low

5. Contact and support

5.1 Repairs/Technical support

Repairs, unless otherwise agreed between the user and the supplier, will be carried out by the manufacturer. For this purpose, the device must be sent to the manufacturer. In order to ensure a fast and smooth handling of a support request or a repair, we kindly ask you to visit the support section of our website at www.elektroautomatik.com/en/service in the first step, and submit your support or repair request by filling out the respective form field ("Support Request" or "Repair Request"). Without this data input, no service order can be generated.

5.2 Contact options

Questions or problems with operation of the device, use of optional components, with the documentation or software, can be addressed to technical support either by telephone or e-Mail.

Headquarter	eMail addresses	Telephone
EA Elektro-Automatik GmbH Helmholtzstr. 31-37 41747 Viersen Germany	Technical support: support@elektroautomatik.com All other issues: ea1974@elektroautomatik.com	Switchboard: +49 2162 / 37850 Support: +49 2162 / 378566

EA Elektro-Automatik GmbH & Co. KG

Helmholtzstr. 31-37
41747 Viersen, Germany

Phone: +49 2162 3785 - 0
Fax: +49 2162 16230
ea1974@elektroautomatik.com

www.elektroautomatik.com

EA Elektro-Automatik Inc.

9845 Via Pasar
CA, 92126, San Diego

Phone: +1 (858) 281 2265
sales@elektroautomatik.com

www.eapowered.com

